

# Yealink



## HD IP Conference Phone CP860 User Guide

POWERED BY

**MOMENTUM**

T E L E C O M

Version 81.10  
Mar. 2017

## Copyright

**Copyright © 2017 YEALINK(XIAMEN) NETWORK TECHNOLOGY CO., LTD.**

Copyright © 2017 Yealink(Xiamen) Network Technology CO., LTD. All rights reserved. No parts of this publication may be reproduced or transmitted in any form or by any means, electronic or mechanical, photocopying, recording, or otherwise, for any purpose, without the express written permission of Yealink(Xiamen) Network Technology CO., LTD. Under the law, reproducing includes translating into another language or format.

When this publication is made available on media, Yealink(Xiamen) Network Technology CO., LTD. gives its consent to downloading and printing copies of the content provided in this file only for private use but not for redistribution. No parts of this publication may be subject to alteration, modification or commercial use. Yealink(Xiamen) Network Technology CO., LTD. will not be liable for any damages arising from use of an illegally modified or altered publication.

## Warranty

THE SPECIFICATIONS AND INFORMATION REGARDING THE PRODUCTS IN THIS GUIDE ARE SUBJECT TO CHANGE WITHOUT NOTICE. ALL STATEMENTS, INFORMATION, AND RECOMMENDATIONS IN THIS GUIDE ARE BELIEVED TO BE ACCURATE AND PRESENTED WITHOUT WARRANTY OF ANY KIND, EXPRESS OR IMPLIED. USERS MUST TAKE FULL RESPONSIBILITY FOR THEIR APPLICATION OF PRODUCTS.

YEALINK(XIAMEN) NETWORK TECHNOLOGY CO., LTD. MAKES NO WARRANTY OF ANY KIND WITH REGARD TO THIS GUIDE, INCLUDING, BUT NOT LIMITED TO, THE IMPLIED WARRANTIES OF MERCHANTABILITY AND FITNESS FOR A PARTICULAR PURPOSE. Yealink(Xiamen) Network Technology CO., LTD. shall not be liable for errors contained herein nor for incidental or consequential damages in connection with the furnishing, performance, or use of this guide.

## Declaration of Conformity



Hereby, Yealink Network Technology CO., LTD. declares that this phone is in conformity with the essential requirements and other relevant provisions of the CE, FCC.

You can find the CE and FCC information from the label on the back of the IP phone.

Statements of compliance can be obtained by contacting [support@yealink.com](mailto:support@yealink.com).

## CE Mark Warning

This device is marked with the CE mark in compliance with EC Directives 2014/35/EU and 2014/30/EU.

## Part 15 FCC Rules

Any changes or modifications not expressly approved by the party responsible for compliance could void the user's authority to operate the equipment.

This device complies with Part 15 of the FCC Rules. Operation is subject to the following two conditions:

1. This device may not cause harmful interference, and
2. this device must accept any interference received, including interference that may cause undesired operation.

## Industry Canada (IC)

This Class [B] digital apparatus complies with Canadian ICES-003 Rules.

## Class B Digital Device or Peripheral

Note: This equipment has been tested and found to comply with the limits for a Class B digital device, pursuant to part 15 of the FCC Rules. These limits are designed to provide reasonable protection against harmful interference in a residential installation. This equipment generates, uses and can radiate radio frequency energy and, if not installed and used in accordance with the instructions, may cause harmful interference to radio communications. However, there is no guarantee that interference will not occur in a particular installation. If this equipment does cause harmful interference to radio or television reception, which can be determined by turning the equipment off and on, the user is encouraged to try to correct the interference by one or more of the following measures:

1. Reorient or relocate the receiving antenna.
2. Increase the separation between the equipment and receiver.
3. Connect the equipment into an outlet on a circuit different from that to which the receiver is connected.
4. Consult the dealer or an experienced radio/TV technician for help.

## WEEE Warning



To avoid the potential effects on the environment and human health as a result of the presence of hazardous substances in electrical and electronic equipment, end users of electrical and electronic equipment should understand the meaning of the crossed-out wheeled bin symbol. Do not dispose of WEEE as unsorted municipal waste and have to collect such WEEE separately.

## Customer Feedback

We are striving to improve our documentation quality and we appreciate your feedback. Email your opinions and comments to [DocsFeedback@yealink.com](mailto:DocsFeedback@yealink.com).

## GNU GPL INFORMATION

Yealink CP860 IP conference phone firmware contains third-party software under the GNU General Public License (GPL). Yealink uses software under the specific terms of the GPL. Please refer to the GPL for the exact terms and conditions of the license.

The original GPL license, source code of components licensed under GPL and used in Yealink products can be downloaded online:

<http://www.yealink.com/GPLOpenSource.aspx?BaseInfoCateId=293&NewsCateId=293&CateId=293>.

## About This Guide

Thank you for choosing the CP860 IP conference phone, a Yealink's first IP conference phone which is exquisitely designed for small and medium-sized conference room, meeting for 10 people below. Users can also benefit from optional expansion microphones for wider reception. This conference phone provides business telephony features, such as Call Hold, Call Transfer, Call and Conference Recording, Multicast Paging and five-way Conference over an IP network.

This guide provides everything you need to quickly use your new phone and expansion microphone. First, verify with your system administrator that the IP network is ready for phone configuration. Also be sure to read the Packaging Contents and Regulatory Notices sections in this guide before you set up and use the CP860 IP conference phone.

## In This Guide

Topics provided in this guide include:

- Chapter 1 [Overview](#)
- Chapter 2 [Getting Started](#)
- Chapter 3 [Customizing Your Phone](#)
- Chapter 4 [Basic Call Features](#)
- Chapter 5 [Advanced Phone Features](#)

## Summary of Changes

This section describes the changes to this guide for each release and guide version.

## Changes for Release 81, Guide Version 81.10

The following sections are new:

- [Connecting the Optional Expansion PSTN Box CPN10](#) on page 15
- [Entering Data and Editing Fields](#) on page 20
- [Power Saving](#) on page 23
- [Key Tone](#) on page 35
- [Favorite Directory](#) on page 46
- [Yealink Cloud Account](#) on page 59
- [Call Park](#) on page 90

- [Idle Recording](#) on page 102
- [Using Your Phone with PSTN Account](#) on page 131
- [Appendix B - Menu Structure](#) on page 157
- [Appendix C - Unavailable Features for PSTN](#) on page 158

Major updates have occurred to the following sections:

- [Icon Instructions](#) on page 3
- [Setup Wizard](#) on page 16
- [Phone Status](#) on page 17
- [Language](#) on page 27
- [Time & Date](#) on page 28
- [Phone Lock](#) on page 30
- [Volume](#) on page 32
- [Local Directory](#) on page 37
- [Programable Keys](#) on page 53
- [Dial Plan](#) on page 62
- [Emergency Number](#) on page 67
- [Local Conference](#) on page 87
- [Call and Conference Recording](#) on page 99
- [Incoming Intercom Calls](#) on page 105
- [Using SCA Feature on the IP Phone](#) on page 116
- [Short Message Service \(SMS\)](#) on page 123
- [Voice Mail](#) on page 125

## Changes for Release 80, Guide Version 80.10

Major updates have occurred to the following sections:

- [Icon Instructions](#) on page 3
- [Setup Wizard](#) on page 16

## Changes for Release 80, Guide Version 80.5

The following sections are new:

- [Logo Customization](#) on page 52
- [Call Completion](#) on page 77
- [Shared Call Appearance \(SCA\)](#) on page 113
- [Bridged Line Appearance \(BLA\)](#) on page 118
- [Short Message Service \(SMS\)](#) on page 123

Major updates have occurred to the following sections:

- [Backlight](#) on page 26
- [Time & Date](#) on page 28
- [Phone Lock](#) on page 30
- [Ring Tones](#) on page 33
- [Directory](#) on page 36
- [Remote Phone Book](#) on page 48
- [Programmable Keys](#) on page 53
- [Account Registration](#) on page 58
- [Auto Answer](#) on page 75
- [Do Not Disturb \(DND\)](#) on page 81
- [Call Forward](#) on page 82
- [Intercom](#) on page 104
- [Multicast Paging](#) on page 106
- [Appendix](#) on page 155

## Changes for Release 72, Guide Version 72.8

Major updates have occurred to the following section:

- [Connecting the Optional Expansion Microphone CPE80](#) on page 12

## Changes for Release 72, Guide Version 72.3

Major updates have occurred to the following sections:

- [Local Directory](#) on page 37
- [Programmable Keys](#) on page 52
- [Dial Plan](#) on page 62

- [Conference](#) on page [87](#)
- [Intercom](#) on page [104](#)
- [Troubleshooting](#) on page [139](#)



# Table of Contents

<b>About This Guide .....</b>	<b>v</b>
In This Guide.....	v
Summary of Changes.....	v
Changes for Release 81, Guide Version 81.10 .....	v
Changes for Release 80, Guide Version 80.10 .....	vi
Changes for Release 80, Guide Version 80.5 .....	vii
Changes for Release 72, Guide Version 72.8 .....	vii
Changes for Release 72, Guide Version 72.3 .....	vii
<b>Table of Contents .....</b>	<b>ix</b>
<b>Overview .....</b>	<b>1</b>
Hardware Component Instructions.....	1
Icon Instructions .....	3
LED Instructions.....	5
User Interfaces .....	5
Phone User Interface .....	6
Web User Interface.....	6
Documentations .....	8
<b>Getting Started .....</b>	<b>9</b>
Packaging Contents.....	9
Optional Accessories .....	10
Phone Installation.....	11
Connecting the Network and Power .....	11
Connecting the Optional Expansion Microphone CPE80.....	12
Connecting the Optional USB Flash Drive .....	15
Connecting the Optional Expansion PSTN Box CPN10.....	15
Connecting the Optional PC or Mobile Device.....	16
Setup Wizard .....	16
Phone Status.....	17
Basic Network Settings .....	18
Registration .....	20
Idle Screen .....	20
Entering Data and Editing Fields.....	20

## **Customizing Your Phone..... 23**

General Settings .....	23
Power Saving .....	23
Contrast.....	26
Backlight.....	26
Language.....	27
Time & Date .....	28
Administrator Password .....	29
Key As Send.....	30
Phone Lock.....	30
Audio Settings .....	32
Volume .....	32
Ring Tones.....	33
Key Tone.....	35
Contact Management .....	35
Directory.....	36
Local Directory.....	37
Blacklist.....	45
Favorite Directory .....	46
Remote Phone Book.....	48
Call History Management .....	49
Viewing History Records.....	49
Placing a Call from History Records .....	50
Adding a Contact to the Local Directory/Blacklist .....	50
Deleting History Records.....	50
Disabling History Record .....	51
Search Source List in Dialing.....	51
System Customizations.....	52
Logo Customization .....	52
Programable Keys.....	53
Account Registration .....	58
Dial Plan .....	62
Emergency Number.....	67
Live Dialpad .....	68
Hotline.....	69

## **Using Your Phone with SIP/Cloud Account..... 71**

Basic Call Features .....	71
Placing Calls.....	72
Answering Calls .....	73
Ending Calls .....	74
Redialing Numbers.....	74

Recent Call In Dialing .....	74
Auto Answer .....	75
Auto Redial .....	76
Call Completion .....	77
ReCall .....	78
Call Mute .....	78
Call Hold/Resume .....	80
Do Not Disturb (DND) .....	81
Call Forward .....	82
Call Transfer .....	85
Call Waiting .....	87
Conference .....	87
Call Park .....	90
Call Pickup .....	94
Anonymous Call .....	97
Anonymous Call Rejection .....	98
Advanced Phone Features .....	98
Recording Using a USB Flash Drive .....	99
Intercom .....	104
Multicast Paging .....	106
Music on Hold .....	112
Shared Call Appearance (SCA) .....	113
Bridged Line Appearance (BLA) .....	118
Messages .....	123
Using PC or Mobile Device with the Conference Phone .....	128
<b>Using Your Phone with PSTN Account .....</b>	<b>131</b>
Configuring the PSTN Account .....	131
Default Account .....	132
Selecting the Country for PSTN Use .....	132
Flash Time .....	132
Basic Call Features .....	133
Placing Calls .....	133
Answering Calls .....	134
Ending Calls .....	135
Redialing Numbers .....	135
Recent Call In Dialing .....	135
Auto Answer .....	135
Auto Redial .....	136
ReCall .....	136
Call Mute .....	136
Call Hold/Resume .....	136
Conference .....	136
Advanced Phone Features .....	138

Recording Using a USB Flash Drive .....	138
Using PC or Mobile Device with the Conference Phone.....	138
<b>Troubleshooting .....</b>	<b>139</b>
General Issues.....	139
Display Issues.....	139
Password Issues .....	140
Call Issues .....	141
Audio Issues.....	141
Network Issues .....	143
Log Issues .....	145
Reboot & Upgrade & Reset Issues .....	147
<b>Regulatory Notices .....</b>	<b>151</b>
Service Agreements .....	151
Limitations of Liability.....	151
Safety Instructions .....	151
<b>Appendix.....</b>	<b>155</b>
Appendix A - Time Zones.....	155
Appendix B - Menu Structure.....	157
Appendix C - Unavailable Features for PSTN .....	158
<b>Index .....</b>	<b>159</b>

# Overview

This chapter provides the overview of the CP860 IP conference phone. Topics include:

- [Hardware Component Instructions](#)
- [Icon Instructions](#)
- [LED Instructions](#)
- [User Interfaces](#)
- [Documentations](#)



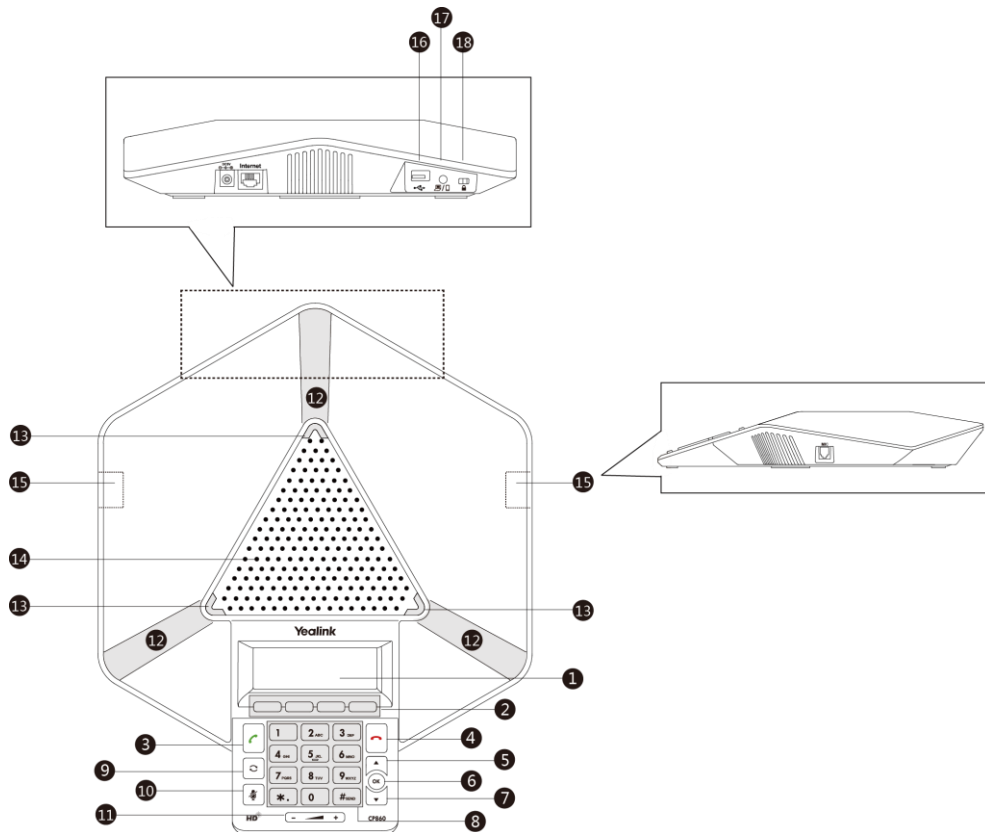

If you require additional information or assistance with your new phone, contact your system administrator.

## Hardware Component Instructions

The following figure shows the primary hardware component of CP860 IP conference phone:



Hardware component instructions of the CP860 IP conference phone are:

	Item	Description
①	LCD Screen	Shows information about calls, messages, soft keys, time, date and other relevant data: <ul style="list-style-type: none"> <li>• Call information—caller ID, call duration</li> <li>• Icons (for example, )</li> <li>• Missed call text or second incoming caller information</li> <li>• Prompt text (for example, "Saving config file!")</li> <li>• Time and date</li> </ul>
②	Soft Keys	Label automatically to identify their context-sensitive features.
③	Off-hook Key	Enters the dialing screen, places a call or answers a call.
④	On-hook Key	Ends a call or returns to the idle screen.
⑤		<ul style="list-style-type: none"> <li>• Scrolls through the displayed information upwards.</li> <li>• Views call history list when the phone is idle.</li> </ul>
⑥		Confirms actions or answers incoming calls.
⑦		<ul style="list-style-type: none"> <li>• Scrolls through the displayed information downwards.</li> <li>• Views the directory list when the phone is idle.</li> </ul>
⑧	Keypad	Provides the digits, letters, and special characters in context-sensitive applications.
⑨	Redial Key	Redials a previously dialed number.
⑩	Mute Key	Toggles mute feature.
⑪	Volume Key	Adjusts the volume of the speaker, ringer or media.
⑫	Three Internal Microphones	Provide 10-feet (3-meters) and 360-degree coverage to transmit sound to other phones.
⑬	LED Indicators	Indicate phone and call statuses.
⑭	Speaker	Provides hands-free (speakerphone) audio output.
⑮	Two MIC Ports	Allow you to connect two expansion microphones to your phone (optional).
⑯	USB Port	<ul style="list-style-type: none"> <li>• Allows you to connect a USB flash drive (optional) to your phone so you can record calls/conferences and play back recorded files.</li> <li>• Allows you to connect expansion PSTN box(es) (optional) to experience calls in PSTN. Up to two cascaded expansion PSTN boxes can be connected, so you can experience the local three-way conference conveniently in excellent speech quality with PSTN.</li> </ul>

	Item	Description
⑰	PC/Mobile Port	Allows you to connect an optional PC or Mobile Device to your phone so you can connect the PC or mobile device audio to your phone.
⑱	Security Slot	Allows you to connect a universal security cable to your phone so you can lock down your phone. The phone will not be removed after locked.

The following figure shows the primary hardware component of CPE80 expansion microphone (optional):

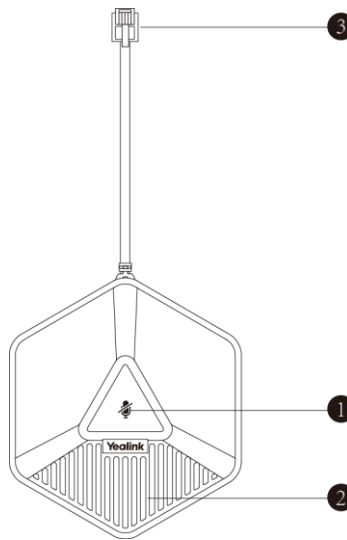

Hardware component instructions of the CPE80 expansion microphone are:























	Item	Description
①	Mute Indicator LED	Toggles and indicates mute feature.
②	Microphone	Transmits sound to other phones.
③	MIC Connector	Allows you to connect to the MIC port on the phone.

## Icon Instructions

Certain features and icons do not apply to PSTN. Therefore, not all icons listed in the table below will display when using PSTN only. Please refer to the relevant sections for more information.

Icons appearing on the LCD screen are described in the following table:

Icon	Description
	Network is unavailable
	Registered successfully (SIP/PSTN account)

Icon	Description
	Registered successfully (Yealink Cloud account)
	Register failed (SIP account)
	Registering (SIP account)
	Hands-free (speakerphone) mode
	Voice Mail
	Text Message
	Auto Answer
	Do Not Disturb (DND)
	Call Hold
	Call Mute
	Ringer volume is 0
	Phone Lock
	Call Forward
	Forwarded Calls
	Missed Calls
	Received Calls
	Placed Calls
	Call and Conference Recording
	Idle Recording
	USB flash drive/PSTN box is detecting
	USB flash drive is detected
	PSTN box is detected



Icon	Description
	High Definition Voice

## LED Instructions

LED indicators on the CP860 IP conference phone and Mute indicator LED on the CPE80 expansion microphone (optional):

LED Status	Description
Solid red	The phone is initializing (This LED status is only applicable to CP860 IP conference phone). The call is muted.
Flashing red	The phone is ringing.
Solid green	The phone places a call. There is an active call on the phone.
Flashing green	The call is placed on hold or is held.
Off	The phone is powered off. The phone is idle.

## User Interfaces

Two ways to customize configurations of your CP860 IP conference phone:

- The user interface on the IP phone.
- The user interface in a web browser on your PC.

The hardware components keypad and LCD screen constitute the phone user interface, which allows the user to execute all call operation tasks and basic configuration changes directly on the phone. In addition, you can use the web user interface to access all configuration settings. In many cases, it is possible to use either the phone user interface and/or the web user interface interchangeably. However, in some cases, it is only possible to use one or the other interface to operate the phone and change settings.

## Phone User Interface

You can customize your phone by pressing the **Menu** soft key to access the phone user interface. The Advanced Settings option is only accessible to the administrator, and the default administrator password is "admin" (case-sensitive). For more information on customizing your phone with the available options from the phone user interface, refer to [Customizing Your Phone](#) on page 23.

**Note** For a better understanding of the menu structure, please refer to [Appendix B - Menu Structure](#) on page 157.

## Web User Interface

In addition to the phone user interface, you can also customize your phone via web user interface. In order to access the web user interface, you need to know the IP address of your new phone. To obtain the IP address, press the OK key on the phone when the phone is idle. Enter the IP address (e.g., http://192.168.0.10 or 192.168.0.10 for IPv4; http://[2005:1:1:1:215:65ff:fe64:6e0a] or [2005:1:1:1:215:65ff:fe64:6e0a] for IPv6) in the address bar of a web browser on your PC. The default administrator user name and password are both "admin" (case-sensitive).

**Note** The access to the Advanced settings of the Account or Network via web user interface may be blocked by the web browser (e.g., Chrome, Firebox) if you have installed "Adblock Plus plugin".

The options you can use to customize the IP phone via phone user interface and/or via web user interface are listed in the following table:

Options	Phone User Interface	Web User Interface
<b>Status</b>		
--IPv4		
--MAC Address		
--Firmware	✓	✓
--Network		
--Phone		
--Accounts		
<b>Basic Phone Settings</b>		
--Power Saving	x	
--Contrast	✓	
--Backlight	✓	✓
--Language	✓	
--Time & Date	✓	
--Administrator Password	✓	

Options	Phone User Interface	Web User Interface
--Key As Send	✓	
--Phone Lock	✓	
-- Audio Settings		
--Ring Tones	✓	
--Key Tone	✓	
--Contact Management		
--Directory	x	
--Local Directory	✓	
--Blacklist	✓	
--Favorite Directory	✓	
--Remote Phone Book	x	
--Call History Management	✓	
--Search Source List in Dialing	x	
--Logo Customization	x	
--Programable Keys	x	
--Account Registration	✓	
--Dial Plan	x	
--Emergency Number	x	
--Live Dialpad	x	
--Hotline	✓	
<b>Basic Call Features</b>		
--Recent Call In Dialing	x	
--Auto Answer	✓	
--Auto Redial	✓	
--Call Completion	✓	
--ReCall	x	
--Do Not Disturb (DND)	✓	✓
--Call Forward	✓	
--Call Waiting	✓	
--Conference	x	
--Call Pickup	✓	
--Anonymous Call	✓	
--Anonymous Call Rejection	✓	
<b>Advanced Phone Features</b>		
--Call and Conference Recording	✓	x
--Idle Recording	✓	x
--Intercom	✓	
--Multicast Paging	x	
--Music on Hold	x	✓
--SCA (Share Call Appearance)	x	
--BLA (Bridge Line Appearance)	x	

Options	Phone User Interface	Web User Interface
--Messages	√	
<b>SIP Account</b>		
--User Options		
--Type	√	
--Active Line	√	
--Label	√	
--Display Name	√	
--Register Name	√	
--User Name	√	√
--Password	√	
--Server Option		
--SIP Server1/2	√	
--Register Port	x	
--Outbound Status	√	
--Outbound Proxy1/2	√	
--Fallback Interval	√	
--NAT Status	√	
<b>Yealink Cloud Account</b>		
--PIN Code		
--PIN Code	√	x
--Account		
--User Name	√	
--Password	√	

**Note** The table above lists most of the feature options. Please refer to the relevant sections for more information.

## Documentations

The following table shows documentations available for the CP860 IP conference phone.

Name	Contents	Where found	Language
Quick Start Guide	Basic call features and phone customizations	In the package	English
		On the website	Chinese/English
User Guide	Phone/Web user interface settings Basic call features and advanced phone features	On the website	Chinese/English

**Note** You can also download the latest documentations online:  
<http://support.yealink.com/documentFront/forwardToDocumentDetailPage?documentId=34>.

## Getting Started

This chapter provides the following basic installation instructions and information for obtaining the best performance with the CP860 IP conference phone. Topics include:

- [Packaging Contents](#)
- [Phone Installation](#)
- [Setup Wizard](#)
- [Phone Status](#)
- [Basic Network Settings](#)
- [Registration](#)
- [Idle Screen](#)

If you require additional information or assistance with your new phone, contact your system administrator.

## Packaging Contents

The following items are included in your CP860 IP conference phone package:

- **CP860 IP Conference Phone**

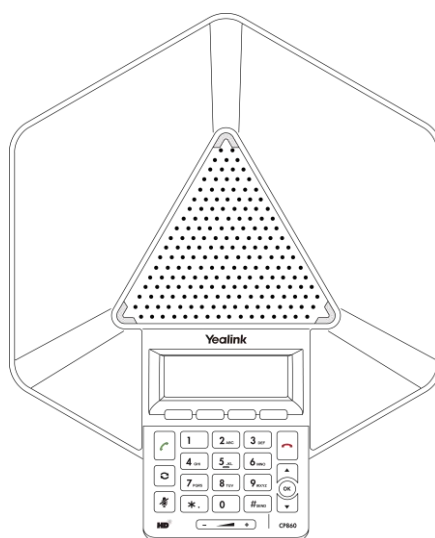

- **3.5mm Jack Cable**



- **Ethernet Cable**

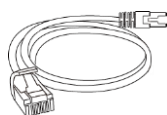

- **Power Adapter**

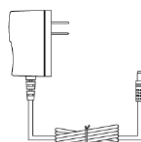

- **Quick Start Guide**

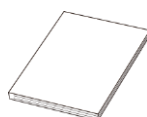

Check the list before installation. If you find anything missing, contact your system administrator.

## Optional Accessories

The following items are optional accessories for your CP860 IP conference phone. You need to purchase them separately if required.

- **Expansion Microphone CPE80**

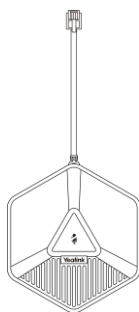

- **Expansion PSTN Box CPN10**



PSTN Box CPN10



3m PSTN Cable

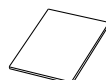

Double-side Tape



Quick Start Guide

## Phone Installation

If your phone has already installed, proceed to [Setup Wizard](#) on page 16.

This section introduces how to install the phone:

- 1) Connecting the Network and Power
- 2) Connecting the Optional Expansion Microphone CPE80
- 3) Connecting the Optional USB Flash Drive
- 4) Connecting the Optional Expansion PSTN Box CPN10
- 5) Connecting the Optional PC or Mobile Device

## Connecting the Network and Power

You have two options for power and network connections. Your system administrator will advise you which one to use.

- AC power (Optional)
- Power over Ethernet (PoE)

### AC Power (Optional)

#### To connect the AC power:

1. Connect the DC plug on the power adapter to the DC5V port on the phone and connect the other end of the power adapter into an electrical power outlet.
2. Connect the included or a standard Ethernet cable between the Internet port on the phone and the one on the wall or switch/hub device port.

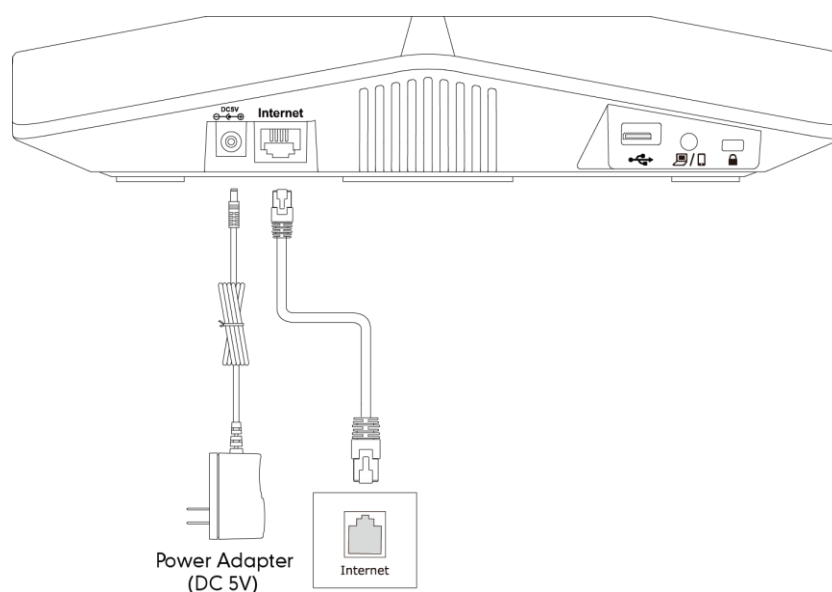

#### Note

The IP phone should be used with Yealink original power adapter (5V/2A) only.

## Power over Ethernet

With the included or a regular Ethernet cable, the CP860 IP conference phone can be powered from a PoE-compliant switch or hub.

### To connect the PoE:

1. Connect the Ethernet cable between the Internet port on the phone and an available port on the in-line power switch/hub.

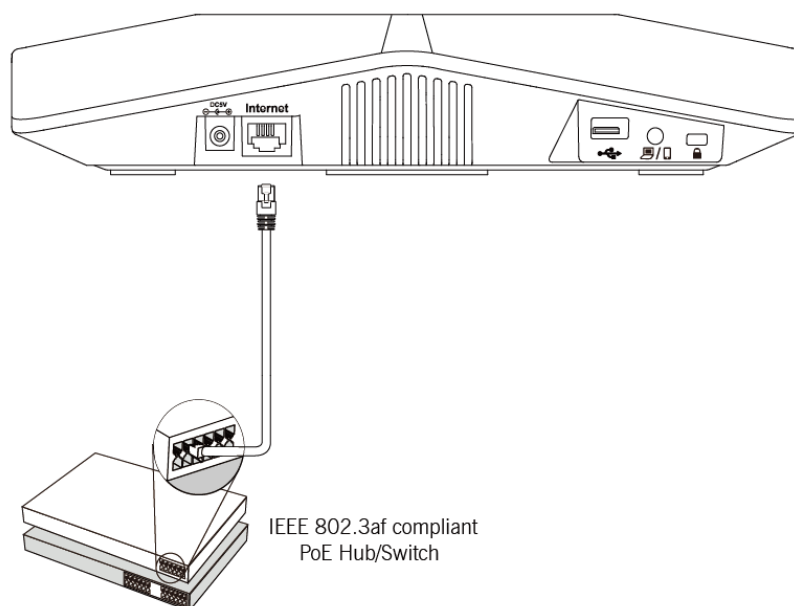

### Note

If in-line power switch/hub is provided, you don't need to connect the phone to the power adapter. Make sure the switch/hub is PoE-compliant.

**Important!** Do not unplug or remove power to the phone while it is updating firmware and configurations.

## Connecting the Optional Expansion Microphone CPE80

You can connect optional expansion microphone to enhance the room coverage of the conference phone.



**To connect the expansion microphone:**

1. Connect the free end of the optional expansion microphone cable to one of the MIC ports on the phone.

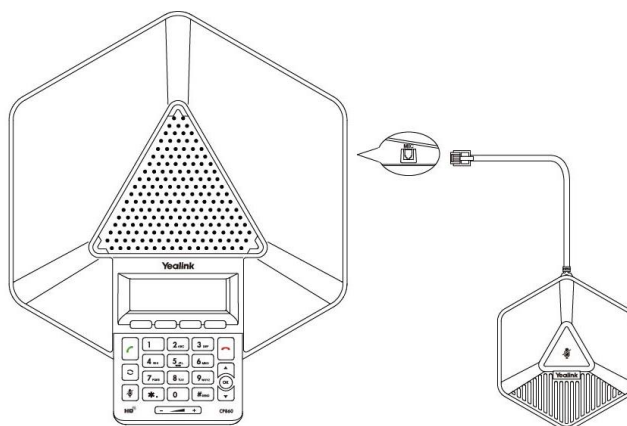

**Note** Up to two expansion microphones can be connected to an IP conference phone.

## Positioning the CP860 and the Expansion Microphone CPE80

The microphone reception of the CP860 conference phone is ideal when placed within 3m of any speaker. The better reception is within 2m.

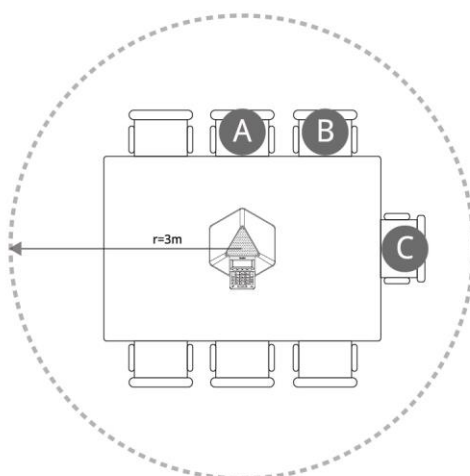

(CP860)

CPE80 is a directional microphone. Its coverage range is 120 degree. Ensure the microphone faces the speaker.

When the size of the conference room is more than 16 (4\*4) square meters or the spacing between a speaker and CP860 IP conference phone is more than 2m, one expansion microphone should be connected to the CP860 IP conference phone.

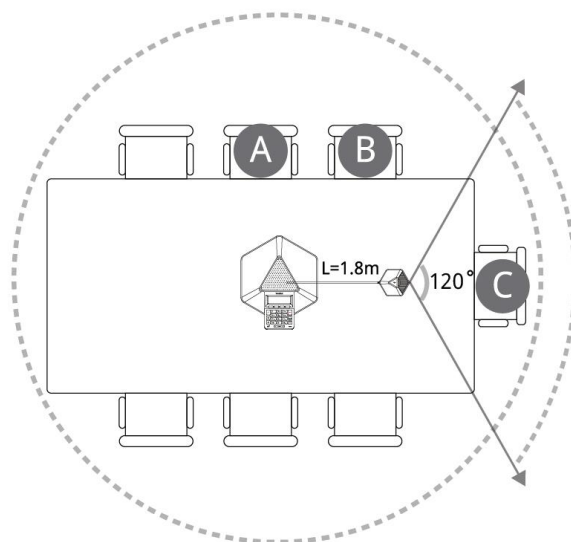

(CP860+single expansion microphone)

When the size of the conference room is more than 36 (6\*6) square meters, two expansion microphones should be connected to the CP860 IP conference phone.

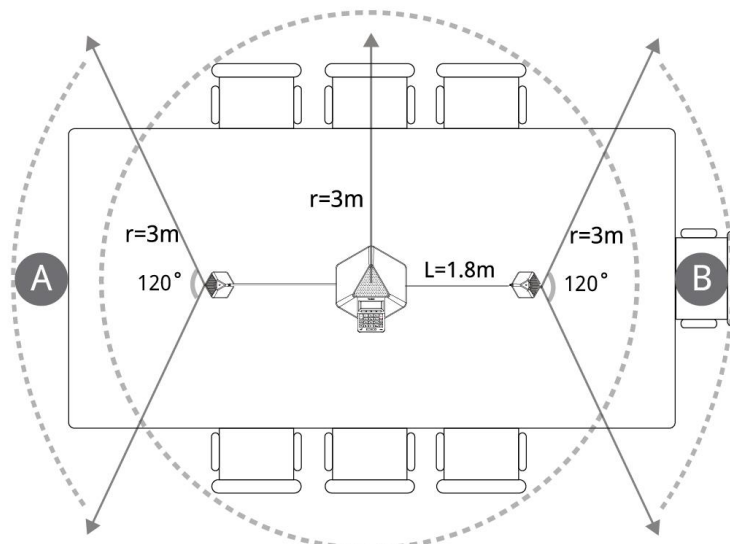

(CP860+two expansion microphones)

Following the following guidelines to ensure optimum performance with the CP860 IP conference phone and the expansion microphones:

- Do not move or handle the CP860 IP conference phone or the expansion microphones

while on a call. Fix the microphone before a call and the better spacing between microphones and participants should be 0.5m to 2m.

- Minimize background noise from air conditioning units, fans or other equipment in conference room. Keep the microphone far away from the noise source.
- Do not speak at the same time; otherwise the microphones capture the voice of all the speakers, causing people in the far site cannot hear clearly.
- Do not move around in the conference room while on a call.

## Connecting the Optional USB Flash Drive

You can connect a USB flash drive to record calls/conferences and play back recorded files.

### To connect a USB flash drive:

1. Insert a USB flash drive into the USB port on the phone.

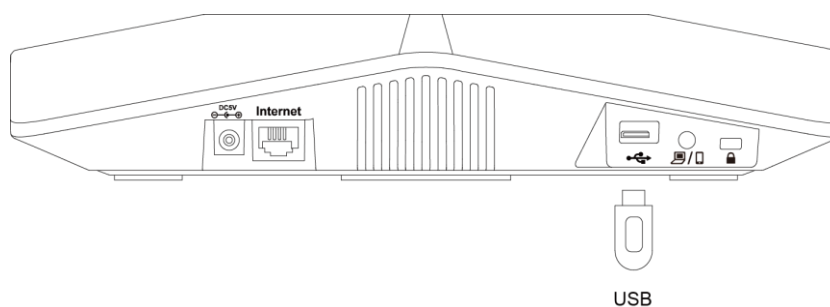

## Connecting the Optional Expansion PSTN Box CPN10

You can connect optional expansion PSTN box CPN10 to make calls using the Public Switched Telephone Network (PSTN).

### To connect the expansion PSTN box:

1. Insert the USB plug on the expansion PSTN box into the USB port on the phone.

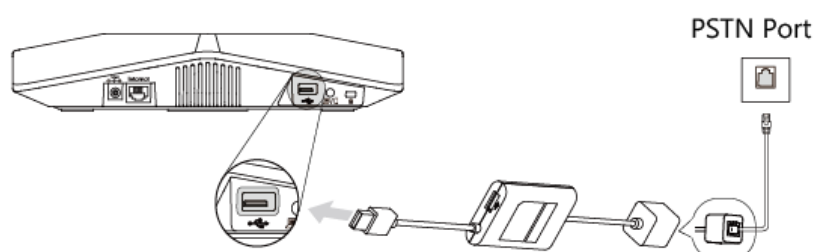

### Note

If you need to record calls when using the PSTN box, you can also connect the USB flash drive to the USB port on the PSTN box. Up to two expansion PSTN boxes can be connected to an IP conference phone. For more information, refer to [Yealink PSTN Box CPN10 Quick Start Guide](#).

## Connecting the Optional PC or Mobile Device

You can connect a PC or mobile device to listen to the PC or mobile audio using your conference phone.

### To connect a PC or mobile device:

1. Connect one end of the 3.5mm jack cable to the PC/mobile port on the phone, and connect the other end to the headset jack on the mobile device or the AUX/MIC jack on the PC.

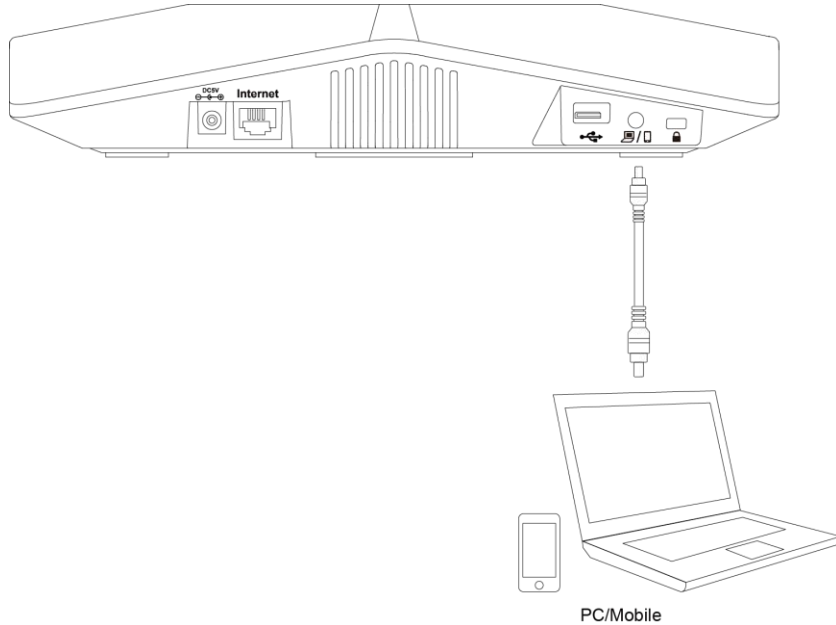

## Setup Wizard

When the IP phone is first powered on or the phone settings are reset to factory defaults, the setup wizard will appear on the LCD screen after startup. You can disable this feature. For more information, contact your system administrator.

### Configure the setup wizard:

1. Configure the language for the phone user interface.  
The default language is English.  
For more information, refer to [Language](#) on page 27.
2. Press the **Next** soft key to continue, or press the **Skip** soft key to skip the setup wizard and go to the idle screen.
3. Configure time and date.  
For more information, refer to [Time & Date](#) on page 28.
4. Press the **Next** soft key to continue.
5. Configure basic network settings for the WAN port.  
For more information, refer to [Basic Network Settings](#) on page 18.

6. Press the **Next** soft key to continue.
7. Configure the SIP account information.  
For more information, refer to [Account Registration](#) on page 58.
8. Press the **Finish** soft key to complete the setup wizard.

After you complete these steps, the LCD screen prompts the following, and then the phone goes to the idle screen.

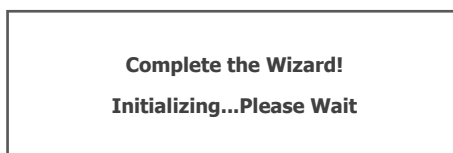



## Phone Status

You can view phone status via phone user interface or web user interface.

Available information of phone status includes:

- Network status (IPv4 status or IPv6 status, IP mode and MAC address).
  - IPv4 uses a 32-bit address.
  - IPv6 is an updated version of the current Internet Protocol to meet the increased demands for unique IP addresses, using a 128-bit address.
- Phone status (product name, hardware version, firmware version, product ID, MAC address and device certificate status).
- Account (SIP, Yealink Cloud or PSTN) status

### To view the phone status via phone user interface:

1. Press , or press **Menu->Status**.
2. Press  or  to scroll through the list and view the specific information.

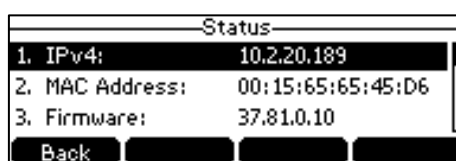

### To view the phone status via web user interface:

1. Open a web browser on your computer.
2. Enter the IP address in the browser's address bar, and then press the **Enter**.

3. Enter the user name (admin) and password (admin) in the login page.

4. Click **Login** to login.

The phone status is displayed on the first page of the web user interface.

Category	Item	Value
Version	Firmware Version	37.81.0.10
	Hardware Version	37.0.0.0.0.0.0
Device Certificate	Device Certificate	Factory Installed
Network	Internet Port	IPv4
IPv4	WAN Port Type	DHCP
	WAN IP Address	10.2.20.189
	Subnet Mask	255.255.255.0
	Gateway	10.2.20.254
	Primary DNS	192.168.1.20
	Secondary DNS	192.168.1.22
Network Common	MAC Address	0015656545D6
	WAN Port Status	100Mbps Full Duplex
	Uptime	0 days 00:04
Account Status	Account	Disabled
	PSTN1	(PSTN1) : Registered

## Basic Network Settings

If your phone cannot contact a DHCP server for any reason, you need to configure network settings manually. The IP phone can support either or both IPv4 and IPv6 addresses.

**To configure the IP mode via phone user interface:**

1. Press **Menu**->**Settings**->**Advanced Settings** (default password: admin)  
->**Network**->**WAN Port**.

- Press the ◀ or ▶ soft key to select **IPv4**, **IPv6** or **IPv4 & IPv6** from the **IP Mode** field.

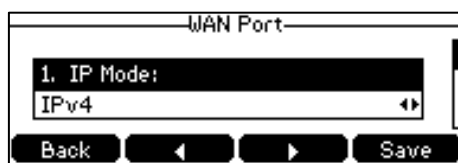

- Press the **Save** soft key to accept the change or the **Back** soft key to cancel.

You can configure a static IPv4 address for the IP phone. Before configuring it, make sure that the IP mode is configured as **IPv4** or **IPv4 & IPv6**.

#### To configure a static IPv4 address via phone user interface:

- Press **Menu->Settings->Advanced Settings** (default password: admin) ->**Network->WAN Port**.
- Press ▾ to select **IPv4** and then press the **Enter** soft key.
- Press ▾ to select **Static IPv4 Client** and then press the **Enter** soft key.
- Enter the desired value in the **IP Address**, **Subnet Mask**, **Default Gateway**, **Pri.DNS** and **Sec.DNS** field respectively.



- Press the **Save** soft key to accept the change or the **Back** soft key to cancel.

You can configure a static IPv6 address for the IP phone. Before configuring it, make sure that the IP mode is configured as **IPv6** or **IPv4 & IPv6**.

#### To configure a static IPv6 address via phone user interface:

- Press **Menu->Settings->Advanced Settings** (default password: admin) ->**Network->WAN Port**.
- Press ▾ to select **IPv6** and then press the **Enter** soft key.
- Press ▾ to select **Static IPv6 Client** and then press the **Enter** soft key.
- Enter the desired value in the **IP Address**, **IPv6 IP Prefix**, **Default Gateway**, **Pri.DNS** and **Sec.DNS** field respectively.



- Press the **Save** soft key to accept the change or the **Back** soft key to cancel.

#### Note

Wrong network settings may result in inaccessibility of your phone and may also have an impact on your network performance. For more information on these parameters, contact your system administrator.

## Registration

Generally, your phone will be deployed with multiple other phones. In this case, your system administrator will configure the phone parameters beforehand, so that after you start up your phone, the phone will be registered and ready for use. If your phone is not registered, you may have to register it. For more information on how to register your phone, refer to [Account Registration](#) on page 58.

## Idle Screen

If the phone has successfully started up, the idle LCD screen is displayed as below.

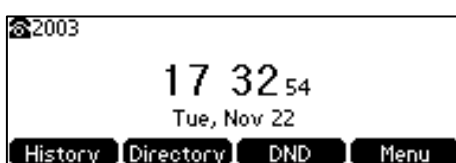

The idle screen displays the label of the current account, time and date, and four soft keys.

## Entering Data and Editing Fields









You can enter data and edit fields using the phone keypad.

Keypad on the phone provides different characters (or numbers) when using the **2aB**, **abc**, **Abc**, **ABC** or **123** input mode. You can change the following input modes to enter data and edit fields on your phone. When your phone keypad matches the input mode, you can press the keypad repeatedly to view the character (or number) options and stop to select. When the character (or number) you want to enter displays in the field, wait for one second, and enter the next character (or number).

The following table lists the input modes and character (or number) options for the keypad:



Input Mode Keypad	2aB	abc	Abc (initials in capitals)	ABC	123
1	1				1
2 <sub>ABC</sub>	2abcABC	abc2äæääá ääç	abc2äæääá ääç	ABC2ÄÆÄ ÀÁÃÇ	2
3 <sub>DEF</sub>	3defDEF	def3èéèèö	def3èéèèö	DEF3ÈÉÈÈÖ	3
4 <sub>GHI</sub>	4ghiGHI	ghi4ìíîï	ghi4ìíîï	GHI4ÌÍÎÏ	4



<b>Input Mode</b> <b>Keypad</b>	<b>2aB</b>	<b>abc</b>	<b>Abc</b> <b>(initials in capitals)</b>	<b>ABC</b>	<b>123</b>
	5jklJKL	jkl5£	jkl5£	JKL5£	5
	6mnoMNO	mno6öøòó ôõñ	mno6öøòó ôõñ	MNO6ÖØ ÒÓÔÕÑ	6
	7pqrsPQRS	pqrs7BS	pqrs7BS	PQRS7S	7
	8tuvTUV	tuv8ùúûü	tuv8ùúûü	TUV8ÙÚÛÜ Û	8
	9wxyzWXYZ Z	wxyz9ýþ	wxyz9ýþ	WXYZ9ÝÞ	9
	0	space	space	space	0
	*.@,'!\-() /:;+&%=< > £\$¥¤[]{}~ ^_`~\$#~	*.@,'!\-() /:;+&%=< > £\$¥¤[]{}~ ^_`~\$#~	*.@,'!\-()@/: /:;+&%=<> £\$¥¤[]{}~ ^_`~\$#~	*.@,'!\-() /:;+&%=< > £\$¥¤[]{}~ ^_`~\$#~	.*:/@[]
	#	#	#	#	#

**To enter or edit data:**

Do one of the following:

<b>If you want to</b>	<b>Then you can</b>
Enter only digits (1), uppercase (A) characters, lowercase (a) characters, or alphanumeric (2aB) characters.	<p>Press a keypad key one or more times (depending on what input mode you're in) to enter the characters that is displayed on the keypad key.</p> <p>You can press the <b>abc</b> soft key one or more times to switch among uppercase (<b>ABC</b> soft key), numeric (<b>123</b> soft key), alphanumeric (<b>2aB</b> soft key), uppercase and lowercase (<b>Abc</b> soft key) and lowercase (<b>abc</b> soft key) input modes.</p> <p>For example, if the input mode is <b>ABC</b>:</p> <ul style="list-style-type: none"> <li>- To enter "A", press  once.</li> <li>- To enter "B", press  twice quickly.</li> </ul>

If you want to	Then you can
	<ul style="list-style-type: none"> <li>- To enter "C", press <b>2<sub>ABC</sub></b> three times quickly.</li> <li>- To enter "2ÄËÄÄÄÄÇ", press <b>2<sub>ABC</sub></b> more than three times quickly.</li> </ul> <p><b>Note:</b> When you are in the uppercase (<b>ABC</b> soft key), uppercase and lowercase (<b>Abc</b> soft key) or lowercase (<b>abc</b> soft key) input mode, <b>1</b> is not available.</p>
Enter special characters.	<p>Press the keypad key <b>#<sub>SEND</sub></b> or <b>*.</b>, or press <b>0</b>.</p> <p><b>For <b>0</b> Key:</b></p> <ul style="list-style-type: none"> <li>- If it is in the uppercase (<b>ABC</b> soft key), uppercase and lowercase (<b>Abc</b> soft key) or lowercase (<b>abc</b> soft key) input mode, it will provide the space character.</li> <li>- If it is in the numeric (<b>123</b> soft key) or alphanumeric (<b>2aB</b> soft key) input mode, it will only provide the digit <b>0</b>.</li> </ul> <p><b>For <b>#<sub>SEND</sub></b> key:</b></p> <ul style="list-style-type: none"> <li>- It only provides the pound character <b>#</b>.</li> </ul> <p><b>For <b>*.</b> key:</b></p> <ul style="list-style-type: none"> <li>- If it is in the uppercase (<b>ABC</b> soft key), lowercase (<b>abc</b> soft key), uppercase and lowercase (<b>Abc</b> soft key) or alphanumeric (<b>2aB</b> soft key) input mode, it will provide the following special characters:  <b>*.,?!\\-()@/:_+&amp;%=&lt;&gt;£\$¥▣[]{}~^!¿\$#"'</b></li> <li>- If it is in the numeric (<b>123</b> soft key) input mode, it will provide the following special characters: <b>.*:/@[]</b>.</li> </ul>
Delete text you entered.	Press the <b>Delete</b> soft key to delete one character at a time.

# Customizing Your Phone

You can customize your CP860 IP conference phone by personally configuring certain settings, for example, backlight, time & date and ring tones. You can add contacts to the phone's local directory manually or from call history. You can also personalize different ring tones for different callers.

This chapter provides basic operating instructions for customizing your phone. Topics include:

- [General Settings](#)
- [Audio Settings](#)
- [Contact Management](#)
- [Call History Management](#)
- [Search Source List in Dialing](#)
- [System Customizations](#)

If you require additional information or assistance with your new phone, contact your system administrator.

## General Settings

### Power Saving

The power saving feature is used to turn off the backlight to conserve energy. The IP phone enters power-saving mode after it has been idle for a certain period of time.

**The IP phone will exit power-saving mode if one of the following phone events occurs:**

- Press any key.
- There is an incoming call.
- A new prompt (e.g., missed call, new voice mail or forwarded call).

You can configure the following power-saving settings:

- Office Hour
- Idle Timeout (minutes)

The office hour and idle timeout (minutes) settings work only if the power saving feature is enabled.

**Note** Power saving is configurable via web user interface only.

## Enabling the Power Saving

To enable the power saving feature via web user interface:

1. Click on **Settings->Power Saving**.
2. Select **Enabled** from the pull-down list of **Power Saving**.

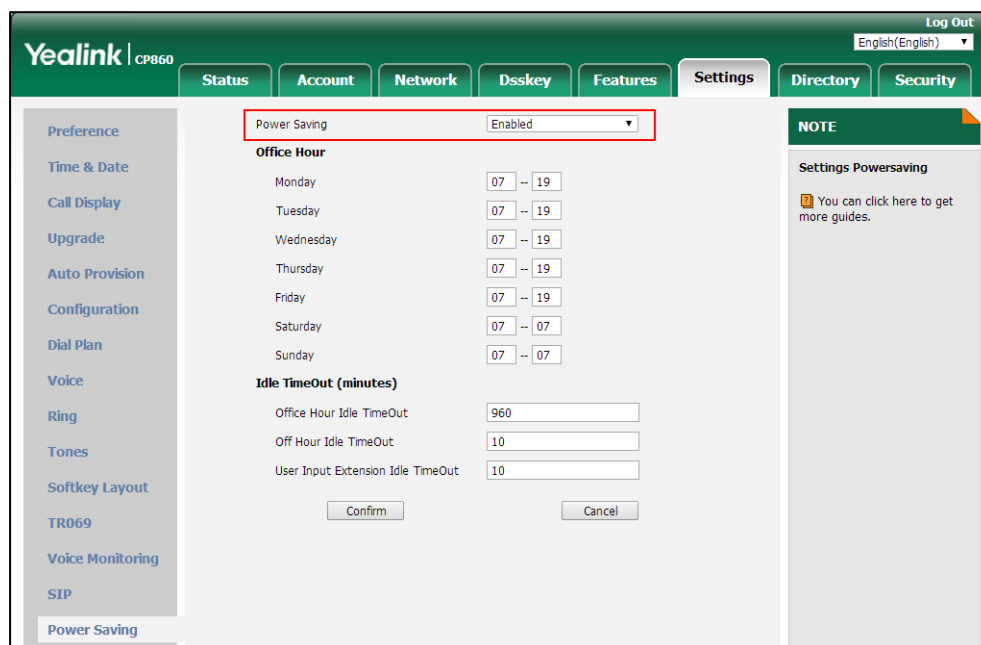

3. Click **Confirm** to accept the change.

## Configuring the Office Hour

Office Hour specifies the starting time and ending time in the office each day.

To configure the office hour via web user interface:

1. Click on **Settings->Power Saving**.

- Enter the starting time and ending time respectively in the desired day field.

The screenshot shows the Yealink CP860 web interface. The 'Settings' tab is active, and the 'Power Saving' section is expanded. The 'Office Hour' section is highlighted with a red box, showing a table of days and their corresponding start and end times. Below this, the 'Idle TimeOut (minutes)' section has three input fields: 'Office Hour Idle TimeOut' (960), 'Off Hour Idle TimeOut' (10), and 'User Input Extension Idle TimeOut' (10). There are 'Confirm' and 'Cancel' buttons at the bottom of the form.

Day	Start Time	End Time
Monday	07	19
Tuesday	07	19
Wednesday	07	19
Thursday	07	19
Friday	07	19
Saturday	07	07
Sunday	07	07

- Click **Confirm** to accept the change.

## Configuring the Idle Timeout

Idle Timeout specifies the period of time before the IP phone enters power-saving mode. The following three types of idle timeout you can configure:

- **Office Hours Idle TimeOut:** Configures the idle timeout for office hours.
- **Off Hours Idle TimeOut:** Configures the idle timeout for non-office hours.
- **User Input Extension Idle TimeOut:** Configures idle timeout that applies after you use the IP phone (for example, press a key on the phone).

By default, the Office Hours Idle Timeout is much longer than the Off Hours Idle TimeOut. If you use the IP phone, the idle timeout that applies (User Input Extension Idle TimeOut or Office Hours/Off Hours Idle TimeOut) is the timeout with the highest value. If the phone has an incoming call or new message, the User Input Extension Idle TimeOut is ignored.

### To configure the idle timeout via web user interface:

- Click on **Settings->Power Saving**.
- Enter the desired value in the **Office Hours Idle TimeOut** field.  
The default value is 960, you can set to 1-960.
- Enter the desired value in the **Off Hours Idle TimeOut** field.  
The default value is 10, you can set to 1-10.
- Enter the desired value in the **User Input Extension Idle TimeOut** field.

The default value is 10, you can set to 1-30.

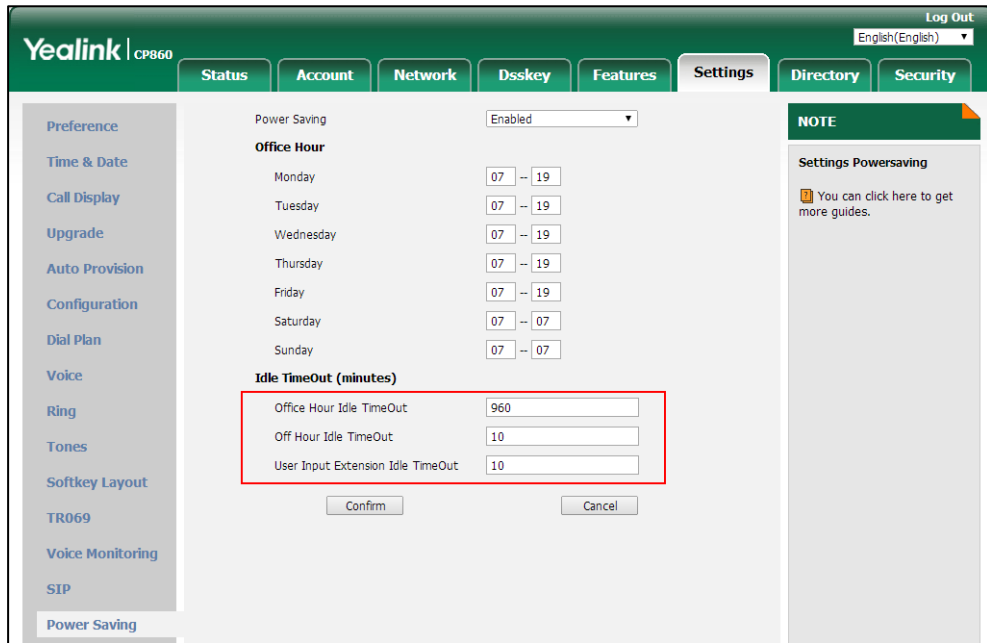

5. Click **Confirm** to accept the change.

## Contrast

You can configure the contrast of the LCD screen to a comfortable level. The intensity of contrast ranges from 1 to 10 and the highest intensity is 10.

### To configure the contrast via phone user interface:

1. Press **Menu->Settings->Basic Settings->Display->Contrast**.
2. Press the ◀ or ▶ soft key to decrease or increase the intensity of contrast.

The default contrast level is "6".



3. Press the **Save** soft key to accept the change or the **Back** soft key to cancel.

Contrast is configurable via web user interface at the path **Settings->Preference**.

## Backlight

You can configure the backlight to adjust the brightness of the LCD screen. Backlight status on the LCD screen can be configured from the following options:

- **Always On:** Backlight is on permanently.

- **Always Off:** Backlight is off permanently.
- **15s, 30s, 1min, 2min, 5min, 10min or 30min:** Backlight is turned off when the phone is inactive after the designated time (in seconds).

#### To configure the backlight via phone user interface:

1. Press **Menu->Settings->Basic Settings->Display->Backlight**.
2. Press the ◀ or ▶ soft key to select the desired value from the **Backlight Time** field.





3. Press the **Save** soft key to accept the change or the **Back** soft key to cancel.

Backlight is configurable via web user interface at the path **Settings->Preference**.

## Language

The default language of the phone user interface is English. If the language of your web browser is not supported by the phone, the web user interface will use English by default. You can change the language for the phone user interface and the web user interface respectively.

#### To change the language for the phone user interface:

1. Press **Menu->Settings->Basic Settings->Language**.
2. Press  or  to select the desired language.



3. Press the **Save** soft key to accept the change.

Text displayed on the phone user interface will change to the selected language.

#### To change the language for the web user interface:

1. Select the desired language from the pull-down list at the top-right corner of web user interface.

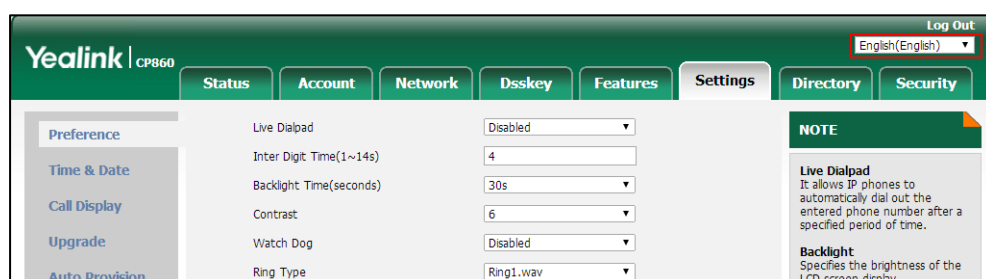

Text displayed on the web user interface will change to the selected language.

## Time & Date

The time and date are displayed on the LCD screen when the phone is idle. You can configure the phone to obtain the time and date from the Simple Network Time Protocol (SNTP) server automatically, or configure the date and time manually. If the phone cannot obtain the time and date from the SNTP server, contact your system administrator for more information.

### To configure the SNTP settings via phone user interface:

1. Press **Menu->Settings->Basic Settings->Time & Date->SNTP Settings**.
2. Press the ◀ or ▶ soft key to select the time zone that applies to your area from the **Time Zone** field.

The default time zone is "+8".

3. Enter the domain name or IP address in the **NTP Server1** and **NTP Server2** field respectively.
4. Press the ◀ or ▶ soft key to select the desired value from the **Daylight Saving** field.



5. Press the ◀ or ▶ soft key to select the desired time zone name from the **Location** field. This field appears only if **Daylight Saving** field is selected to **Automatic**. The default time zone name is "China(Beijing)".
6. Press the **Save** soft key to accept the change or the **Back** soft key to cancel.

### Note

Please refer to [Appendix A - Time Zones](#) for the list of available time zones on the IP phone.

### To configure the time and date manually via phone user interface:

1. Press **Menu->Settings->Basic Settings->Time & Date->Manual Settings**.
2. Enter the specific time and date.

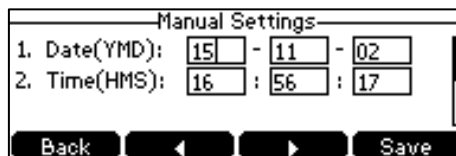

3. Press the **Save** soft key to accept the change.

The date and time displayed on the LCD screen will change accordingly.



**To configure the time and date format via phone user interface:**

1. Press **Menu->Settings->Basic Settings->Time & Date->Time & Date Format**.
2. Press the ◀ or ▶ soft key to select the desired time format (**12 Hour** or **24 Hour**) from the **Time Format** field.



3. Press the ◀ or ▶ soft key to select the desired date format from the **Date Format** field.
4. Press the **Save** soft key to accept the change or the **Back** soft key to cancel.

There are 7 available date formats. For example, for the date format “WWW DD MMM”, “WWW” represents the abbreviation of the weekday, “DD” represents the two-digit day, and “MMM” represents the first three letters of the month.

The date formats available:

Date Format	Example (2016-09-02)
WWW MMM DD	Fri, Sep 02
DD-MMM-YY	02-Sep-16
YYYY-MM-DD	2016-09-02
DD/MM/YYYY	02/09/2016
MM/DD/YY	09/02/16
DD MMM YYYY	02 Sep, 2016
WWW DD MMM	Fri, 02 Sep

Time and date are configurable via web user interface at the path **Settings->Time & Date**.

**Note**

You can also customize the date format. Contact your system administrator for more information.

## Administrator Password

The Advanced Settings option is only accessible to the administrator. The default administrator password is “admin”. For security reasons, you should change the default administrator password as soon as possible.

**To change the administrator password via phone user interface:**

1. Press **Menu->Settings->Advanced Settings** (default password: admin) -> **Change Password**.
2. Enter the current password in the **Old PWD** field.

3. Enter the new password in the **New PWD** field.
4. Re-enter the new password in the **Confirm PWD** field.

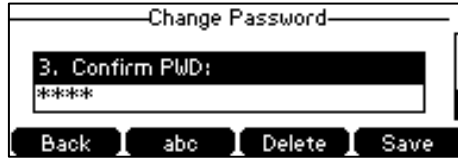

5. Press the **Save** soft key to accept the change or the **Back** soft key to cancel.

Administrator password is configurable via web user interface at the path **Security->Password**.

## Key As Send

You can set the "#" key or "\*" key to perform as a send key while dialing.

**To configure key as send via phone user interface:**

1. Press **Menu->Features->Key As Send**.
2. Press the ◀ or ▶ soft key to select # or \* from the **Key As Send** field, or select **Disabled** to disable this feature.

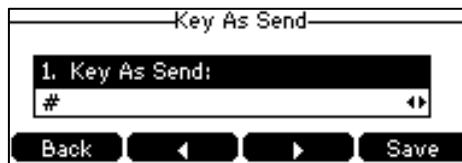

3. Press the **Save** soft key to accept the change or the **Back** soft key to cancel.

Key as send is configurable via web user interface at the path **Features->General Information**.

## Phone Lock

You can lock your phone temporarily when you are not using it. This feature helps to protect your phone from unauthorized use.

Phone lock consists of the following:

- Menu Key:** The **Menu** soft key is locked. You cannot access the menu of the phone until unlocked.
- Function Keys:** The function keys are locked. You cannot use the mute key, redial key, OK key, up and down navigation keys and soft keys until unlocked.
- All Keys:** All keys are locked, except the Volume key, on-hook key, off-hook key, \* key, # key and digit keys. You are only allowed to dial emergency numbers, reject by pressing the **Reject** soft key or on-hook key, answer incoming calls by pressing the **Answer** soft key or off-hook key, and end a call by pressing the **EndCall** soft key

or on-hook key.

**Note**

The emergency number setting, if desired, must be made before lock activation. For more information, refer to [Emergency Number](#) on page 67.

**To activate the phone lock via phone user interface:**

1. Press **Menu->Settings->Basic Settings->Phone Lock**.
2. Enter the desired PIN (default PIN: 123) in the **Unlock PIN** field, and then press the **OK** soft key.
3. Press the ◀ or ▶ soft key to select **Enabled** from the **Lock Enable** field.
4. Press the ◀ or ▶ soft key to select the desired type from the **Lock Type** field.
5. Enter the desired interval of automatic phone lock in the **Lock Time Out** field.

The default timeout is 0. It means the phone will not be automatically locked. You need to long press  to lock it immediately when the phone is idle.

If it is set to other values except 0 (e.g., 5), the phone will be locked when the phone is inactive in idle screen for the designated time (in seconds).



6. Press the **Save** soft key to accept the change.

When the phone is locked, the LCD screen prompts "Phone locked." and displays the icon .



**To change the phone unlock PIN via phone user interface:**

1. Press **Menu->Settings->Basic Settings->Change PIN**.
2. Enter the desired value in the **Old PIN**, **New PIN** and **Confirm PIN** field respectively.

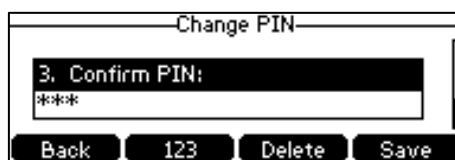

3. Press the **Save** soft key to accept the setting or the **Back** soft key to cancel.



**Note**

The unlock PIN length must be within 15 digits.

**To unlock the phone via phone user interface:**

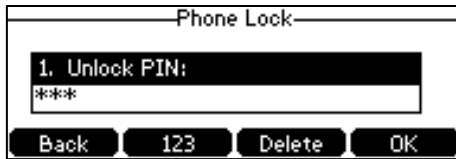
1. Press any locked key, the LCD screen prompts "Unlock PIN".
2. Enter the PIN in the **Unlock PIN** field.



3. Press the **OK** soft key to unlock the keypad.  
 The icon  disappears from the LCD screen.  
 You can long press  or wait for a period of time (if configured) to lock the keypad again.

**Note**

You can also unlock the keypad by entering administrator password. When you enter the administrator password to unlock the keypad, the phone will turn to the Change PIN screen.

**To deactivate the phone lock via phone user interface:**

1. Press **Menu->Settings->Basic Settings->Phone Lock**.
2. Enter the desired PIN (default PIN: 123) in the **Unlock PIN** field, and then press the **OK** soft key.
3. Press the ◀ or ▶ soft key to select **Disabled** from the **Lock Enable** field.

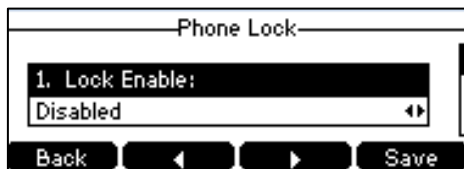

4. Press the **Save** soft key to accept the change.

Phone lock is configurable via web user interface at the path **Features->Phone Lock**.

## Audio Settings

### Volume

You can press the volume key to adjust the ringer volume when the phone is idle or ringing. You can also press the volume key to adjust the speaker volume when the phone is during a call.

**To adjust the ringer volume when the phone is idle:**

1. Press  to adjust the ringer volume.



**To adjust the ringer volume when the phone is ringing:**

1. Press  to adjust the ringer volume.



You can also press  to adjust the ringer volume when selecting a ring tone. For more information, refer to [Ring Tones](#) on page 33.

**Note**

If the ringer volume is adjusted to minimum, the icon  will appear on the LCD screen.

**To adjust the speaker volume when the phone is during a call:**

1. Press  to adjust the speaker volume.



**Note**



You can also press  to adjust the volume when playing back the recording calls. For more information, refer to [Recorded Files Playback](#) on page 102.

## Ring Tones

Ring tones are used to indicate incoming calls. You can select different ring tones to distinguish your phone from your neighbor's, you can also select ring tone for your accounts or contacts on your phone.

**To select a ring tone for the phone via phone user interface:**

1. Press **Menu->Settings->Basic Settings->Sound->Ring Tones->Common.**

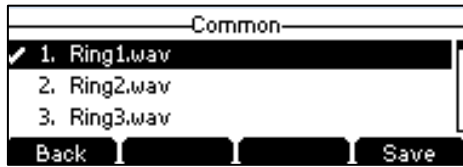

2. Press  or  to select the desired ring tone.





3. (Optional.) Press  to adjust the ringer volume.
4. Press the **Save** soft key to accept the change or the **Back** soft key to cancel.

A ring tone for the phone is configurable via web user interface at the path **Settings->Preference->Ring Type**.

**To select a ring tone for the account via phone user interface:**

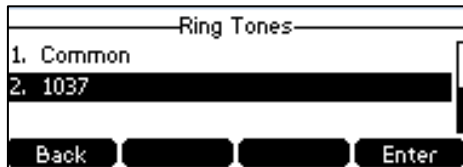
1. Press **Menu->Settings->Basic Settings->Sound->Ring Tones**.
2. Press  or  to select the desired account and then press the **Enter** soft key.



3. Press  or  to select the desired ring tone.  
If **Common** is selected, this account will use the ring tone selected for the phone.

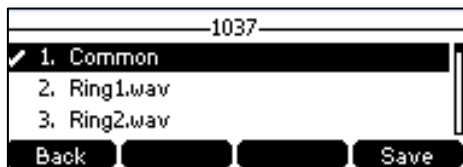

4. (Optional.) Press  to adjust the ringer volume.
5. Press the **Save** soft key to accept the change or the **Back** soft key to cancel.

A ring tone for the account is configurable via web user interface at the path **Account->Basic->Ring Type**.

**To upload a custom ring tone for your phone via web user interface:**

1. Click on **Settings->Preference**.

- In the **Upload Ringtone** field, click **Browse** to locate a ring tone file (the file format must be \*.wav) from your local system.

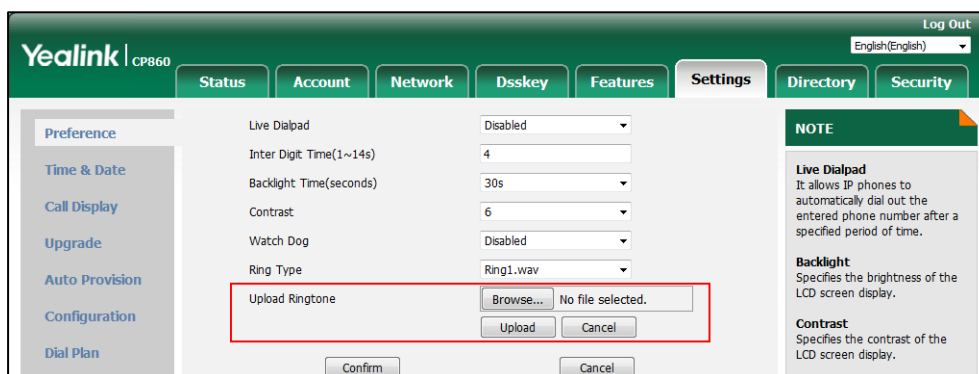

- Click **Upload** to upload the file.

#### Note

The priority of ring tone for an incoming call on the phone is as follows:  
Contact ring tone (refer to [Adding Contacts](#)) > Group ring tone (refer to [Adding Groups](#)) > Account ring tone > Phone ring tone.

Both single custom ring tone file and total custom ring tone files must be within 100KB.

Uploading custom ring tones for your phone is configurable via web user interface only.

## Key Tone

If you enable key tone, the phone will produce a sound when you press the keypad.

**To configure key tone via phone user interface:**

- Press **Menu**->**Settings**->**Basic Settings**->**Sound**->**Key Tone**.
- Press the ◀ or ▶ soft key to select the desired value from the **Key Tone** field.

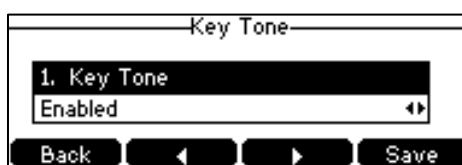

- Press the **Save** soft key to accept the change or the **Back** soft key to cancel.

Key tone is configurable via web user interface at the path **Features**->**Audio**.

## Contact Management

This section provides the operating instructions for managing contacts. Topics include:

- [Directory](#)
- [Local Directory](#)
- [Blacklist](#)

- [Favorite Directory](#)
- [Remote Phone Book](#)





## Directory

Directory provides an easy access to frequently used lists. The lists may contain Local Directory, Favorite Directory, History, Remote Phone Book and LDAP. You can configure the list(s) to be accessed for the **Directory** soft key.

### Note

LDAP list is hidden by default. To configure LDAP list, you need to enable LDAP feature in advance. For more information, contact your system administrator.

### To configure the list(s) to access for the Directory soft key via web user interface:

1. Click on **Directory->Setting**.
2. In the **Directory** block, select the desired list from the **Disabled** column and then click  .  
The selected list appears in the **Enabled** column.
3. Repeat the step 2 to add more lists to the **Enabled** column.
4. To remove a list from the **Enabled** column, select the desired list and click  .
5. To adjust the display order of enabled lists, select the desired list and click  or  .  
The LCD screen will display the list(s) in the adjusted order.

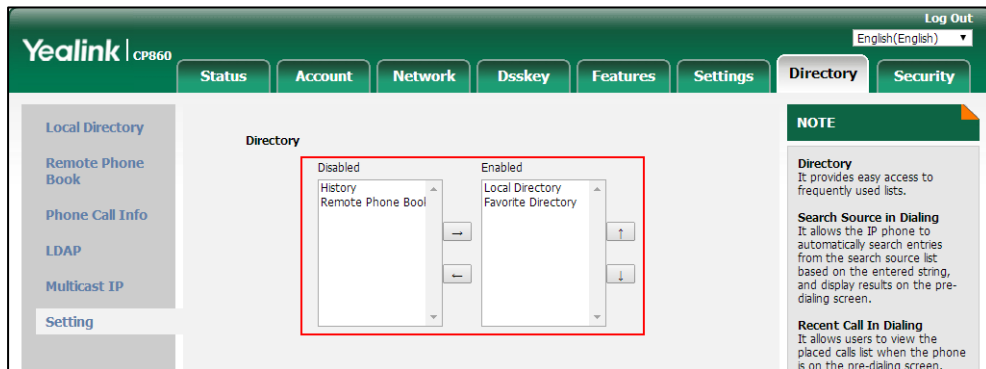

6. Click **Confirm** to accept the change.

### Note

The list(s) to access for the **Directory** soft key is configurable via web user interface only.

### To view the directory list(s) via phone user interface:

1. Press the **Directory** soft key when the phone is idle.



The LCD screen displays the enabled list(s) in the directory.



If there is only one list in the directory, press the **Directory** soft key to enter this list directly.

#### Note

If the remote phone book or LDAP is not configured in advance, you cannot see remote phone book or LDAP lists on the phone user interface. For more information on remote phone book, refer to [Remote Phone Book](#) on page 48. For more information on the LDAP, contact your system administrator.

## Local Directory

The built-in phone directory can store the names and phone numbers of your contacts. You can store up to 1000 contacts and 47 groups in your phone's local directory. You can add new groups and contacts, edit, delete or search for a contact, or simply dial a contact number from the local directory.

#### Note

Local directory can be backed up to the provisioning server. For more information, contact your system administrator.

## Adding Groups

**To add a group to the local directory:**

1. Press **Directory**->**Local Directory**.



If the Local Directory is removed from the directory (refer to [Directory](#) on page 36), press **Menu**->**Directory**->**Local Directory** to enter the local directory.

2. Press the **AddGr** soft key.
3. Enter the desired group name in the **Name** field.
4. Press the ◀ or ▶ soft key to select the desired ring tone from the **Ring** field.

If **Auto** is selected, this group will use the ring tone according to the priority: Contact ring tone (refer to [Adding Contacts](#)) >Account ring tone (refer to [Ring Tones](#)) >Phone ring tone (refer to [Ring Tones](#)). If a specific ring tone is selected, this group will use the ring tone according to the priority: Contact ring tone (refer to [Adding Contacts](#)) >Group ring tone.



5. Press the **Add** soft key to accept the change or the **Back** soft key to cancel.



## Editing Groups

**To edit a group in the local directory:**



1. Press **Directory**->**Local Directory**.



If Local Directory is removed from the directory (refer to [Directory](#) on page 36), press **Menu**->**Directory**->**Local Directory** to enter the local directory.

2. Press  or  to highlight the desired contact group.
3. Press the **Option** soft key, and then select **Detail**.



4. Press  or  to highlight the group information and then edit.



5. Press the **Save** soft key to accept the change or the **Back** soft key to cancel.



## Deleting Groups

To delete a group from the local directory:

1. Press **Directory**->**Local Directory**.



If Local Directory is removed from the directory (refer to [Directory](#) on page 36), press **Menu**->**Directory**->**Local Directory** to enter the local directory.

2. Press  or  to highlight the desired contact group.
3. Press the **Option** soft key, and then select **Delete**.

The LCD screen prompts the following warning:

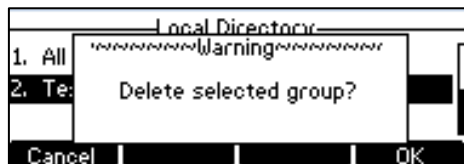

4. Press the **OK** soft key to confirm the deletion or the **Cancel** soft key to cancel.

You can also delete all groups by pressing the **Option** soft key, and then select **Delete All**.

## Adding Contacts

You can add contacts to the local directory in one of the following ways:

- Manually
- From call history
- From a remote phone book

### Adding Contacts Manually

To add a contact to the local directory manually:

1. Press **Directory**->**Local Directory**.



If Local Directory is removed from the directory (refer to [Directory](#) on page 36), press **Menu**->**Directory**->**Local Directory** to enter the local directory.

2. Select the desired contact group and then press the **Enter** soft key.  
If the contact is not in any group, select **All Contacts** and then press the **Enter** soft key.
3. Press the **Add** soft key.
4. Enter the name and the office, mobile or other numbers in the corresponding fields.

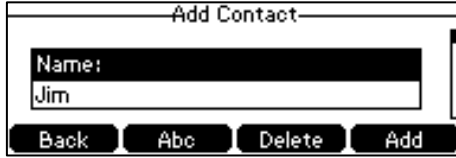

5. Press the ◀ or ▶ soft key to select the desired ring tone from the **Ring** field.  
If **Auto** is selected, this contact will use the ring tone according to the priority: Group ring tone (refer to [Adding Groups](#)) >Account ring tone (refer to [Ring Tones](#))>Phone ring tone (refer to [Ring Tones](#)).
6. Press the ◀ or ▶ soft key to select the desired group from the **Group** field.
7. Press the **Add** soft key to accept the change or the **Back** soft key to cancel.

**Note**

If the contact already exists in the directory, the LCD screen will prompt "Contact name existed!".

### Adding Contacts from Call History

**To add a contact to the local directory from call history:**

1. Press the **History** soft key.
2. Select the desired call history list and then press the **Enter** soft key.
3. Press ▲ or ▼ to highlight the desired entry.
4. Press the **Option** soft key, and then select **Add to Contact**.

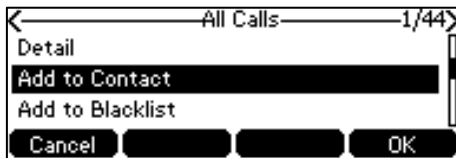



5. Enter the contact name.
6. Press the **Save** soft key to save the entry to the local directory.  
If the contact already exists in the local directory, the LCD screen will prompt "Overwrite the original contact?". Press the **OK** soft key to overwrite the original contact in the local directory or the **Cancel** soft key to cancel.

### Adding Contacts from Remote Phone Book

**To add a contact to the local directory from the remote phone book:**

1. Press **Menu->Directory->Remote Phonebook**.  
If Remote Phone Book is added to the directory (refer to [Directory](#) on page 36), press

**Directory**->**Remote Phone Book** to enter the remote phone book.

2. Select the desired remote group and then press the **Enter** soft key.
3. Press  or  to highlight the desired entry.
4. Press the **Option** soft key, and then select **Add to Contact**.
5. Press the **Save** soft key to save the contact to the local directory.

If the contact already exists in the local directory, the LCD screen will prompt "Overwrite the original contact?". Press the **OK** soft key to overwrite the original contact in the local directory or the **Cancel** soft key to cancel.

For more information on remote phone book operating, refer to [Remote Phone Book](#) on page 48.

## Editing Contacts

**To edit a contact in the local directory:**



1. Press **Directory**->**Local Directory**.





If Local Directory is removed from the directory (refer to [Directory](#) on page 36), press **Menu**->**Directory**->**Local Directory** to enter the local directory.

2. Select the desired contact group and then press the **Enter** soft key.

If the contact is not in any group, select **All Contacts** and then press the **Enter** soft key.

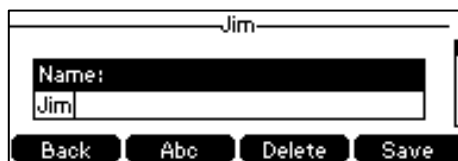
3. Press  or  to highlight the desired contact.
4. Press the **Option** soft key, and then select **Detail**.



5. Press  or  to highlight the contact information and then edit.
6. Press the **Save** soft key to accept the change or the **Back** soft key to cancel.



## Deleting Contacts

To delete a contact from the local directory:

1. Press **Directory->Local Directory**.



If Local Directory is removed from the directory (refer to [Directory](#) on page 36), press **Menu->Directory->Local Directory** to enter the local directory.

2. Select the desired contact group and then press the **Enter** soft key.  
If the contact is not in any group, select **All Contacts** and then press the **Enter** soft key.
3. Press  or  to highlight the desired contact.
4. Press the **Option** soft key, and then select **Delete**.

The LCD screen prompts the following warning:



5. Press the **OK** soft key to confirm the deletion or the **Cancel** soft key to cancel.  
You can also delete all contacts by pressing the **Option** soft key, and then select **Delete All**.



## Placing Calls to Contacts

To place a call to a contact from the local directory:

1. Press **Directory->Local Directory**.



If Local Directory is removed from the directory (refer to [Directory](#) on page 36), press **Menu->Directory->Local Directory** to enter the local directory.

2. Select the desired contact group and then press the **Enter** soft key.  
If the contact is not in any group, select **All Contacts** and then press the **Enter** soft key.
3. Press  or  to highlight the desired contact.
4. Do one of the following:
  - If only one number for the contact is stored in the local directory, press the **Send** soft

key to dial out the number.

- If multiple numbers for the contact are stored in the local directory, press the **Send** soft key to display a list of numbers.

Press  or  to highlight the desired number.

Press the **Send** soft key to dial out the number.

## Searching for Contacts

**To search for a contact in the local directory:**

1. Press **Directory->Local Directory**.



If Local Directory is removed from the directory (refer to [Directory](#) on page 36), press **Menu->Directory->Local Directory** to enter the local directory.

2. Press the **Search** soft key.
3. Enter a few continuous characters of the contact name or continuous numbers of the contact number (office, mobile or other number) using the keypad.

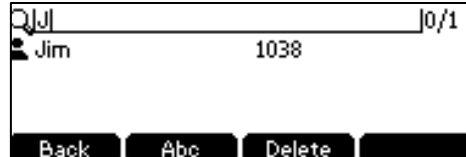

The contacts whose name or phone number matches the characters entered will appear on the LCD screen. You can dial from the result list.

## Importing/Exporting Contact Lists

You can manage your phone's local directory via phone user interface or web user interface. But you can only import or export the contact list via web user interface.

**To import an XML contact list file via web user interface:**

1. Click on **Directory->Local Directory**.
2. Click **Browse** to locate a contact list file (the file format must be \*.xml) from your local system.

3. Click **Import XML** to import the contact list.

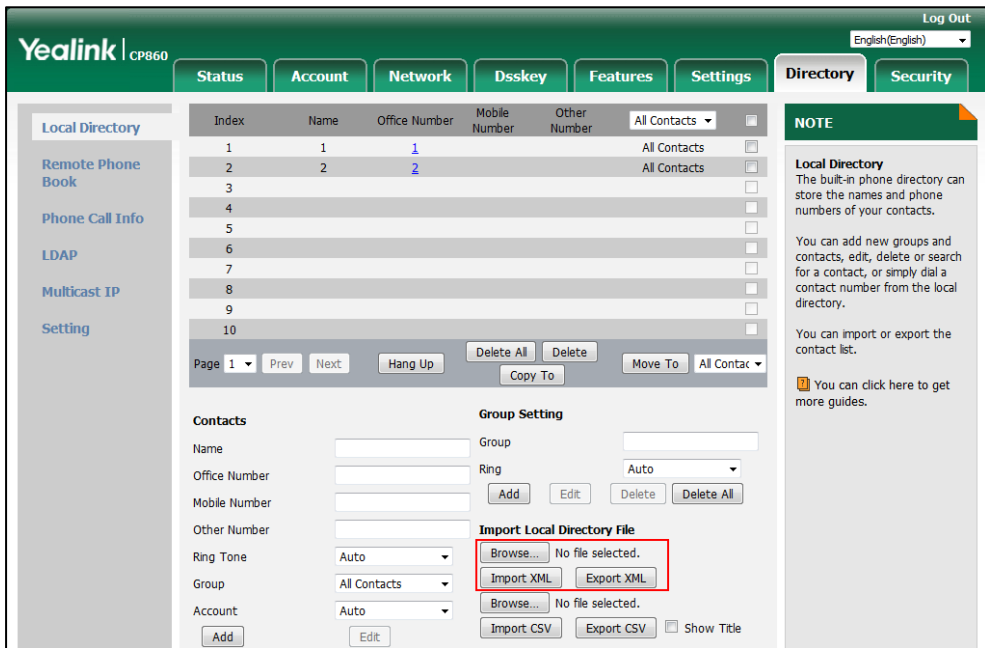

The web user interface prompts "The original contact will be covered, Continue?".

4. Click **OK** to complete importing the contact list.

**To import a CSV contact list file via web user interface:**

1. Click on **Directory->Local Directory**.
2. Click **Browse** to locate a contact list file (the file format must be \*.csv) from your local system.
3. (Optional.) Check the **Show Title** checkbox.

It will prevent importing the title of the contact information which is located in the first line of the CSV file.

4. Click **Import CSV** to import the contact list.
5. (Optional.) Mark the **On** radio box in the **Delete Old Contacts** field.

It will delete all existing contacts while importing the contact list.

6. Select the contact information you want to import into the local directory from the pull down list of **Index**.



At least one item should be selected to be imported into the local directory.

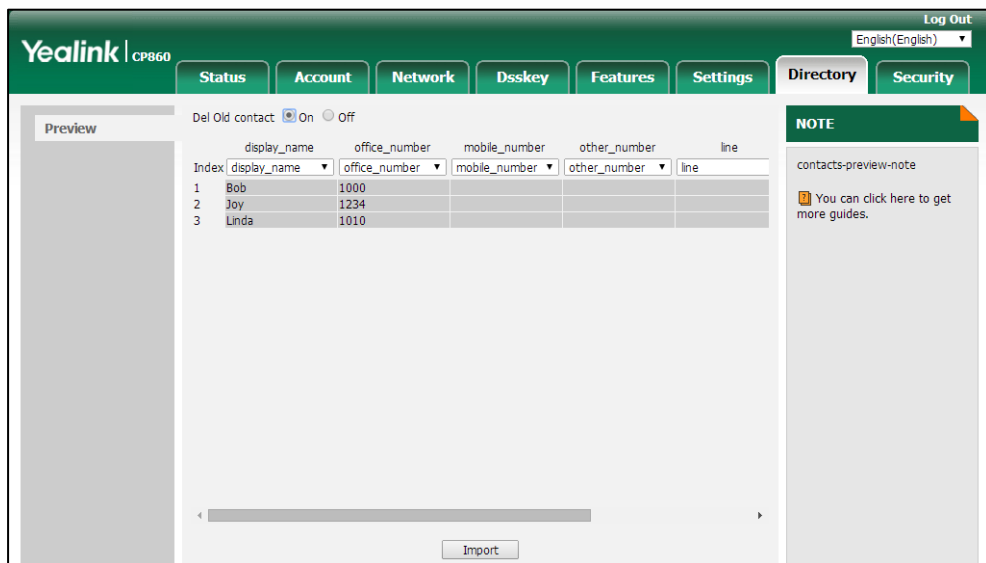

7. Click **Import** to complete importing the contact list.

**To export a contact list via web user interface:**

1. Click on **Directory->Local Directory**.
2. Click **Export XML** (or **Export CSV**).
3. Click **Save** to save the contact list to your local system.

**Note** Importing/exporting contact lists is available via web user interface only.

## Blacklist

The built-in phone directory can store names and phone numbers for a blacklist. You can store up to 30 contacts, add, edit, delete or search for a contact in the blacklist directory, and even call a contact from the blacklist directory. Incoming calls from blacklist directory contacts will be rejected automatically.

**To add a contact to the blacklist directory manually:**

1. Press **Menu->Directory->Blacklist**.
2. Press the **Add** soft key.
3. Enter the name and the office, mobile or other numbers in the corresponding fields.

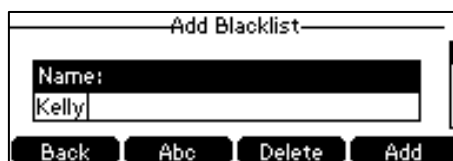

4. Press the **Add** soft key to accept the change or the **Back** soft key to cancel.

**To add a contact to the blacklist directory from the local directory:**

1. Press **Directory->Local Directory**.



If Local Directory is removed from the directory (refer to [Directory](#) on page 36), press **Menu->Directory->Local Directory** to enter the local directory.

2. Select the desired contact group and then press the **Enter** soft key.

If the contact is not in any group, select **All Contacts** and then press the **Enter** soft key.

3. Press or to highlight the desired contact.
4. Press the **Option** soft key, and then select **Add to Blacklist**.

The LCD screen prompts following warning:



5. Press the **OK** soft key to confirm the setting.

For operating instructions on editing, deleting, placing calls to and/or searching for contacts in the blacklist, refer to the operating instructions of [Editing Contacts](#) on page 41, [Deleting Contacts](#) on page 42, [Placing Calls to Contacts](#) on page 42 and/or [Searching for Contacts](#) on page 43.

## Favorite Directory

Favorites are the contacts in your local directory that you call most often. You can add up to 1000 contacts as favorites from the local directory. You can view the favorites in the favorite directory. You can also remove contacts or search for a contact, or simply dial a contact number from the favorite directory.

**To add a contact to the favorite directory from the local directory:**

1. Press **Directory->Local Directory**.

If Local Directory is removed from the directory (refer to [Directory](#) on page 36), press **Menu->Directory->Local Directory** to enter the local directory.

2. Select the desired contact group and then press the **Enter** soft key.

If the contact is not in any group, select **All Contacts** and then press the **Enter** soft key.

3. Press or to highlight the desired contact.
4. Press the **Option** soft key, and then select **Copy to Favorite**.

The LCD screen prompts following warning:



5. Press the **OK** soft key to confirm the setting.



The contact added to the favorite directory from the local directory also exists in the local directory.

You can delete favorites to make room for new favorites.

**To remove a contact from the favorite directory:**

1. Press **Directory->Favorite Directory**.

If Favorite Directory is removed from the directory (refer to [Directory](#) on page 36), press **Menu->Directory->Favorite Directory** to enter the favorite directory.

2. Press  or  to highlight the desired contact.
3. Press the **Remove** soft key.

The LCD screen prompts following warning:



4. Press the **OK** soft key to confirm the deletion.

If the contact added to the favorite directory is deleted in the local directory, it will be automatically deleted from the favorite directory.

For operating instructions on placing a call to a contact from the favorite directory, refer to the operating instructions of [Placing Calls to Contacts](#) on page 42.

**To search for a contact in the favorite directory:**

1. Press **Directory->Favorite Directory**.

If Favorite Directory is removed from the directory (refer to [Directory](#) on page 36), press **Menu->Directory->Favorite Directory** to enter the favorite directory.

2. Enter a few continuous numbers of the contact number (office, mobile or other number) using the keypad.

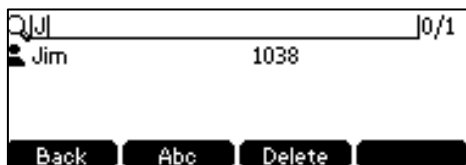

The contacts whose phone number matches the characters entered will appear on the LCD screen. You can dial from the result list.

## Remote Phone Book

You can add new contacts to the local directory, search for a contact, or simply dial a contact number from the remote phone book.

You can configure your new phone to access up to 5 remote phone books. The phone supports up to 5000 remote phone book entries. For the access URL of the remote phone book, contact your system administrator.

For operating instructions on placing calls to and/or searching for contacts in the remote phone book, refer to the operating instructions of [Placing Calls to Contacts](#) on page 42 and/or [Searching for Contacts](#) on page 43.

## Configuring an Access URL and Update Time Interval

**To configure an access URL and update time interval for a remote phone book via web user interface:**

1. Click on **Directory->Remote Phone Book**.
2. Enter the access URL in the **Remote URL** field.
3. Enter the name in the **Display Name** field.
4. Enter the desired refresh period in the **Update Time Interval(Seconds)** field.

The default value is 21600.

5. Click **Confirm** to accept the change.

### Note

An access URL and update time interval for a remote phone book is configurable via web user interface only.

## Accessing the Remote Phone Book

**To access your remote phone book via phone user interface:**

1. Press **Menu->Directory->Remote Phonebook**.

If Remote Phone Book is added to the directory (refer to [Directory](#) on page 36), press **Directory->Remote Phone Book** to enter the remote phone book.

2. Select the desired remote group, and then press the **Enter** soft key.

The phone then connects to the remote phone book and proceeds to load it. The contacts in the remote phone book are displayed on the LCD screen.



3. Press the **Back** soft key to back to the previous screen.

## Incoming/Outgoing Call Lookup

You can enable the phone to present the caller/callee identity stored in the remote phone book when receiving/placing a call.

**To configure incoming/outgoing call lookup via web user interface:**

1. Click on **Directory**->**Remote Phone Book**.
2. Select **Enabled** from the pull-down list of **Incoming/Outgoing Call Lookup**.

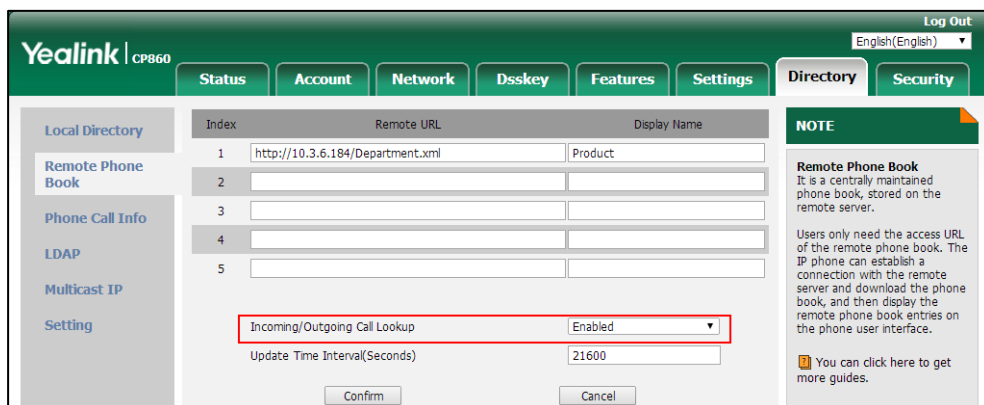

3. Click **Confirm** to accept the change.

## Call History Management

The CP860 IP conference phone maintains call history lists of Missed Calls, Placed Calls, Received Calls and Forwarded Calls. Call history lists support 400 entries in all. You can view call history, place a call, add a contact or delete an entry from the call history list.



History record feature enables the phone to save the call history. If you don't want to save the call history, you can disable the feature. History record feature is enabled by default.

## Viewing History Records

**To view call history:**

1. Press the **History** soft key.



The LCD screen displays all call history lists.

2. Select the desired call history list and then press the **Enter** soft key.
3. Press  or  to select the desired entry.
4. Press the **Option** soft key, and then select **Detail**.

The detailed information of the entry appears on the LCD screen.



## Placing a Call from History Records

**To place a call from the call history list:**

1. Press the **History** soft key.
2. Select the desired call history list and then press the **Enter** soft key.
3. Press  or  to select the desired entry.
4. Press the **Send** soft key.

## Adding a Contact to the Local Directory/Blacklist

**To add a contact to the local directory (or blacklist directory) from the call history list:**

1. Press the **History** soft key.
2. Select the desired call history list and then press the **Enter** soft key.
3. Press  or  to select the desired entry.
4. Press the **Option** soft key, and then select **Add to Contact** (or **Add to Blacklist**).

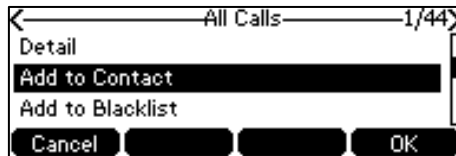



5. Enter the desired values in the corresponding fields.
6. Press the **Save** soft key to accept the change.

For more information on local directory and/or blacklist, refer to [Local Directory](#) on page 37 and/or [Blacklist](#) on page 45.

## Deleting History Records

**To delete an entry from the call history list:**

1. Press the **History** soft key.
2. Select the desired call history list and then press the **Enter** soft key.
3. Press  or  to select the desired entry.
4. Press the **Delete** soft key.

**To delete all entries from the call history list:**

1. Press the **History** soft key.
2. Select the desired call history list and then press the **Enter** soft key.
3. Press the **Option** soft key, and then select **Delete All**.
4. Press the **OK** soft key.

The LCD screen prompts "Delete all the call records?".



5. Press the **OK** soft key to confirm the deletion or the **Cancel** soft key to cancel.

## Disabling History Record

**To disable history record feature via phone user interface:**

1. Press **Menu->Features->History Setting**.
2. Press the ◀ or ▶ soft key to select **Disabled** from the **History Record** field.



3. Press the **Save** soft key to accept the change or the **Back** soft key to cancel.

## Search Source List in Dialing

You can search for a contact from the desired lists when the phone is on the dialing screen. The lists can be Local Directory, History, Remote Phone Book and LDAP.

**Note**



LDAP list is hidden by default. To configure LDAP list, you need to enable LDAP feature in advance. For more information, contact your system administrator.

**To configure search source list in dialing via web user interface:**

1. Click on **Directory->Setting**.
2. In the **Search Source List In Dialing** block, select the desired list from the **Disabled** column and click .

The selected list appears in the **Enabled** column.

3. Repeat the step 2 to add more lists to the **Enabled** column.
4. To remove a list from the **Enabled** column, select the desired list and click .

- To adjust the display order of the enabled lists, select the desired list and click  or . The LCD screen will display search results in the adjusted order.

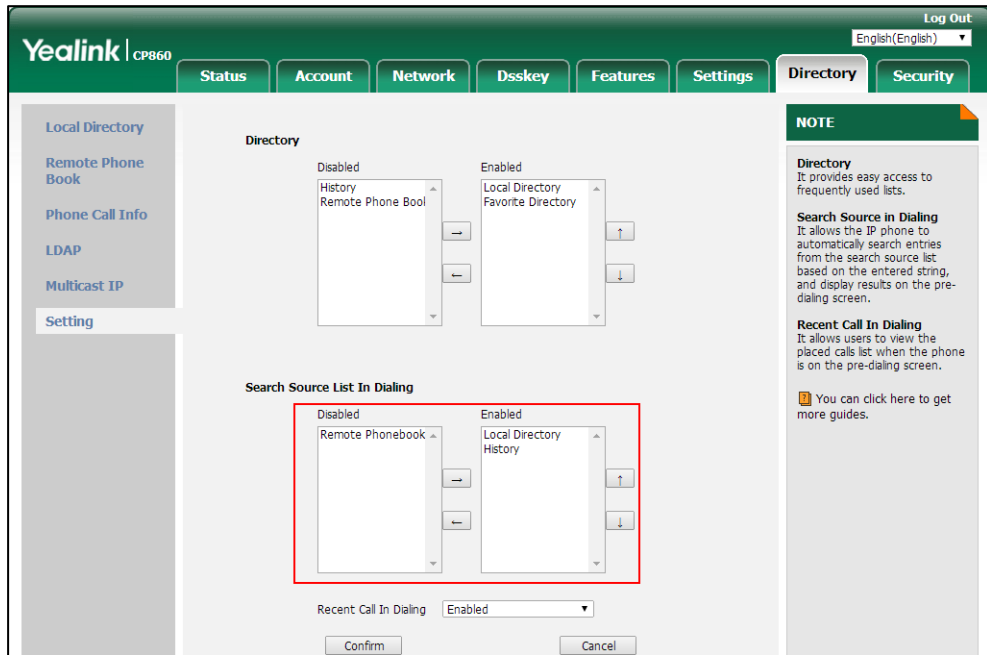



- Click **Confirm** to accept the change.

**Note** Search source list in dialing is configurable via web user interface only.

**To search for an entry in the enabled search source lists:**

- Press .
- Enter a few continuous characters of the entry's name or continuous numbers of the entry's phone number (office, mobile or other number) using the keypad.

The entries in the enabled search source lists whose name or phone number matches the characters entered will appear on the LCD screen. You can press  or  to scroll to the desired entry, and then place a call to the entry.

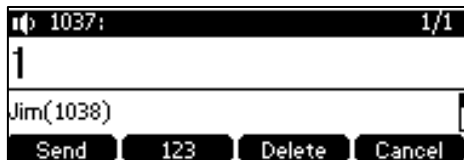

## System Customizations

### Logo Customization

You can upload your custom logo which will be shown on the idle screen.



**To upload a custom logo via web user interface:**

1. Click on **Features**->**General Information**.
2. Select **Custom logo** from the pull-down list of **Use Logo**.
3. Click **Browse** to locate the logo file from your local system.

The screenshot shows the Yealink CP860 web interface. The 'Features' tab is selected, and the 'General Information' sub-tab is active. The 'Use Logo' dropdown menu is set to 'Custom logo'. The 'Upload Logo' section is highlighted with a red box, showing a 'Browse...' button and the text 'No file selected.' Below this, there are 'Upload' and 'Cancel' buttons. The 'General Information' section includes various settings such as 'Call Waiting', 'Auto Redial', and 'Accept SIP Trust Server Only'. A 'NOTE' section on the right provides details for 'Call Waiting', 'Auto Redial', 'Key As Send', 'Hotline', and 'Call Completion'.

4. Click **Upload** to upload the file.

**Note**

**Delete** item will appear after you upload a custom logo, you can click **Delete** to delete the custom logo.

The logo file format must be \*.dob, contact your system administrator for more information.

Logo customization is configurable via web user interface only.

## Programable Keys

The CP860 IP conference phone supports 8 programable keys. You can assign predefined functionalities to programable keys. Programable keys allow you to quickly access features such as SMS. The key type N/A indicates that this programable key provides no functionality until configuration. Details will be introduced in the following. Some features listed in this chapter are not available for PSTN accounts. For more information, refer to [Appendix C - Unavailable Features for PSTN](#) on page 158.

**To customize programable keys via web user interface:**

1. Click on **Dsskey**->**Programable Key**.

## 2. Customize specific features for these keys.

Key	Type	Line	Value	Label	Extension
SoftKey 1	History	Local History			
SoftKey 2	Directory	N/A			
SoftKey 3	DND	N/A			
SoftKey 4	Menu	N/A			
Up	History	Local History			
Down	Local Favorite	N/A			
OK	Status	N/A			
MUTE	N/A	N/A			

3. (Optional.) Enter the string that will appear on the LCD screen in the **Label** field.

Label is configurable only when customizing Softkeys (1-4).

4. Click **Confirm** to accept the change.

You can click **Reset To Default** to reset custom settings to defaults.

**Note**

You also can assign predefined functionalities to soft keys via phone user interface.

Programmable key features are explained in the following subchapters in detail:

- Prefix
- Local Group
- XML Group
- LDAP
- Forward
- DND
- Phone Lock
- Directory
- Local Favorite
- Speed Dial
- Direct Pickup
- Group Pickup
- XML Browser
- SMS
- New SMS
- Zero Touch

For the features not listed above, refer to [Basic Call Features](#) on page 71 and [Advanced Phone Features](#) on page 98. For more information, contact your system administrator.

## Prefix

You can use this key feature to add a specified prefix number before the dialed number.

**Dependencies:** *Type (Prefix)*

*Label (key label displayed on the LCD screen)*

*Value (the prefix number)*

**Usage:** Press the **Prefix** key when the phone is idle, the phone will then enter the dialing screen and display the prefix number that you specified in the **Value** field. You can enter the remaining digits and then dial out.

## Local Group

You can use this key feature to quickly access a contact group in the local directory. For more information, refer to [Local Directory](#) on page 37.

**Dependencies:** *Type (Local Group)*

*Line (the group you want to access)*

*Label (key label displayed on the LCD screen)*

**Usage:** Press the **Local Group** key to access the contact group specified in the **Local Group** field.

## XML Group

You can use this key feature to quickly access a remote group in your remote phone book. You should configure remote phone book in advance. For more information, refer to [Remote Phone Book](#) on page 48.

**Dependencies:** *Type (XML Group)*

*Line (the remote group you want to access if the remote phone book is configured)*

*Label (key label displayed on the LCD screen)*

**Usage:** Press the **XML Group** key to access the remote group specified in the **Line** field.

## LDAP

You can use this key feature to quickly access a LDAP search screen.

**Dependencies:** *Type (LDAP)*

*Label (key label displayed on the LCD screen)*

**Usage:**

1. Press the **LDAP** key to access the LDAP search screen.
2. Enter a few continuous characters of the contact name or continuous numbers of the contact number using the keypad.

The contacts whose name or phone number matches the characters entered will appear on the LCD screen.

**Note**

LDAP is disabled by default. For more information, contact your system administrator.

### Forward

You can use this key feature to forward an incoming call to someone else. For more information, refer to [Call Forward](#) on page 82.

**Dependencies:** *Type (Forward)*

*Label (key label displayed on the LCD screen)*

**Usage:** Press the **Forward** key to enter the forward configuration screen.

### DND

You can use this key feature to activate or deactivate DND. For more information, refer to [Do Not Disturb \(DND\)](#) on page 81.

**Dependencies:** *Type (DND)*

*Label (key label displayed on the LCD screen)*

**Usage:**

1. Press the **DND** key to activate DND.
2. Press the **DND** key again to deactivate DND.

#### Note

When DND is activated, the incoming calls will be rejected automatically.

### Phone Lock

You can use this key feature to immediately lock the keypad of your phone instead of long pressing . For more information, refer to [Phone Lock](#) on page 30.

**Dependencies:** *Type (Phone Lock)*

*Label (key label displayed on the LCD screen)*

**Usage:** Press the **Phone Lock** key to immediately lock the keypad of your phone instead of long pressing .

### Directory

You can use this key feature to easily access frequently used lists. For more information, refer to [Directory](#) on page 36.

**Dependencies:** *Type (Directory)*

*Label (key label displayed on the LCD screen)*

**Usage:** Press the **Directory** key to immediately access frequently used lists.

#### Note

The **Directory** key performs the same function as the **Directory** soft key when the phone is idle.

### Local Favorite

You can use this key feature to easily access favorite directory. For more information, refer to [Favorite Directory](#) on page 46.

**Dependencies:** *Type (Local Favorite)*

**Label** (*key label displayed on the LCD screen*)

**Usage:** Press the **Local Favorite** key to immediately access favorite directory.

### Speed Dial

You can use this key feature to speed up dialing the numbers frequently used or hard to remember.

**Dependencies:** *Type (Speed Dial)*

**Label** (*key label displayed on the LCD screen*)

**Value** (*the number you want to dial out*)

**Usage:** Press the **Speed Dial** key to dial out the number specified in the **Value** field.

### Direct Pickup

You can use this key feature to answer someone else's incoming call on the phone.

**Dependencies:** *Type (Direct Pickup)*

**Label** (*key label displayed on the LCD screen*)

**Value** (*the directed call pickup code followed by the target phone number*)

**Usage:** Press the **Direct Pickup** key on your phone when the target phone number receives an incoming call. The call is then answered on your phone.

### Group Pickup

You can use this key feature to answer incoming calls in a group that is associated with their own group.

**Dependencies:** *Type (Group Pickup)*

**Label** (*key label displayed on the LCD screen*)

**Value** (*the group pickup feature code*)

**Usage:** Press the **Group Pickup** key on your phone when a phone number in the group receives an incoming call. The call is answered on your phone.

### XML Browser

You can use this key feature to access the XML browser quickly. The XML browser allows you to create custom services which meet your functional requirements on the server. You can customize practical applications, such as weather report, stock information, Google search, etc.

**Dependencies:** *Type (XML Browser)*

**Label** (*key label displayed on the LCD screen*)

**Value** (*the access URL for xml browser*)

**Usage:** Press the **XML Browser** key to access the XML browser specified in the **Value** field.

### SMS

You can use this key feature to quick access text message. For more information, refer to [Short Message Service \(SMS\)](#) on page 123.

**Dependencies:** *Type (SMS)*

**Label** (*key label displayed on the LCD screen*)

**Usage:** Press the **SMS** key when the phone is idle to access the text message.

### **New SMS**

You can use this key feature to quick access the new text message. For more information, refer to [Short Message Service \(SMS\)](#) on page 123.

**Dependencies:** *Type (New SMS)*

**Label** (*key label displayed on the LCD screen*)

**Usage:** Press the **New SMS** key when the phone is idle to access the New Message screen. You can enter the text message and then send it.

### **Zero Touch**

You can use this key feature to configure auto provision and network parameters quickly.

**Dependencies:** *Type (Zero Touch)*

**Label** (*key label displayed on the LCD screen*)

**Usage:**

1. Press the **Zero Touch** key to access the zero touch screen.
2. Press the **OK** soft key in a few seconds.
3. Configure the network parameters in the corresponding fields.
4. Press the **Next** soft key.
5. Configure the auto provision parameters in the corresponding fields.
6. Press the **OK** soft key.

The phone will reboot to update configurations.

## **Account Registration**

You can only register one SIP account (common account) or one Yealink Cloud account on the CP860 IP conference phone. Besides you can register one Yealink Cloud account on up to five Cloud endpoints.

If you have connected an expansion PSTN box CPN10 to the phone, a PSTN account is automatically registered on the phone. For more information, refer to [Configuring the PSTN Account](#) on page 131.

## **SIP Account**

You can register only one SIP account on the phone.

**To register a SIP account via phone user interface:**

1. Press **Menu->Settings->Advanced Settings** (default password: admin) -> **Accounts**.
2. Press the **Enter** soft key.
3. Press the ◀ or ▶ soft key to select **Common Account** from the **Type** field.

4. Press the ◀ or ▶ soft key to select **Enabled** from the **Active Line** field.

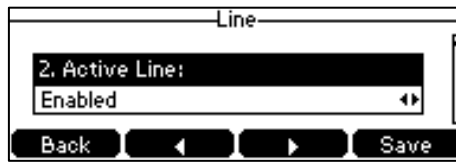

5. Enter the desired value in **Label**, **Display Name**, **Register Name**, **User Name**, **Password** and **SIP Server1/2** field respectively. Contact your system administrator for more information.
6. If you use the outbound proxy servers, do the following:
  - 1) Press the ◀ or ▶ soft key to select **Enabled** from the **Outbound Status** field.
  - 2) Enter the desired value in the **Outbound Proxy1/2** and **Fallback Interval** field respectively. Contact your system administrator for more information.
7. Press the **Save** soft key to accept the change or the **Back** soft key to cancel.

**To disable a SIP account via phone user interface:**

1. Press **Menu->Settings->Advanced Settings** (default password: admin) ->**Accounts**.
2. Press the **Enter** soft key.
3. Press the ◀ or ▶ soft key to select **Common Account** from the **Type** field.
4. Press the ◀ or ▶ soft key to select **Disabled** from the **Account Status** field.
5. Press the **Save** soft key to accept the change or the **Back** soft key to cancel.

Registering a SIP account is configurable via web user interface at the path **Account->Register**.

## Yealink Cloud Account

You can register only one Cloud account on the phone.

### Configuring Cloud Feature

To register a Yealink Cloud account, you need to enable Cloud feature in advance.

**To enable Cloud feature via web user interface:**

1. Click on **Features->General Information**.

2. Select **Enabled** from the pull-down list of **Cloud Enable**.

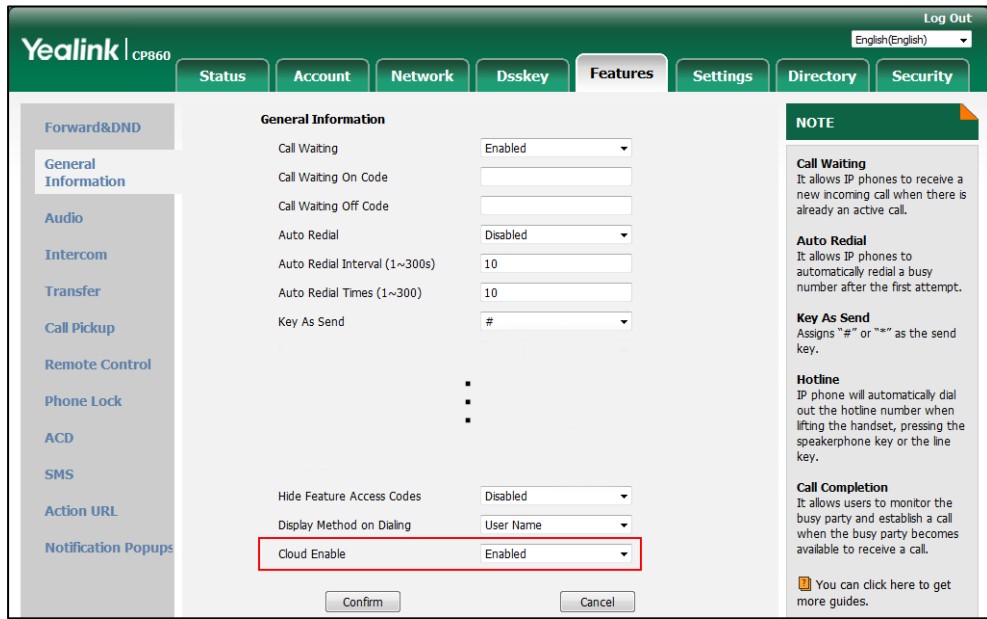

3. Click **Confirm** to accept the change.

**Note** Cloud feature is configurable via web user interface only.

## Yealink Cloud Account Registration

Two methods of registering a Yealink Cloud account are:

- PIN code: This method uses the user's PIN code to register the Yealink Cloud account. The PIN code consists of 9 numbers.
- Account: This method uses the user's username (Cloud number) and password to register the Yealink Cloud account.

You can obtain the Yealink Cloud account information from your Cloud enterprise administrator.

### PIN Code

**To register a Yealink Cloud account by using the PIN code:**

1. Press **Menu**->**Settings**->**Advanced Settings** (default password: admin) ->**Accounts**.
2. Press the **Enter** soft key.



- Press the ◀ or ▶ soft key to select **Yealink Cloud** from the **Type** field.

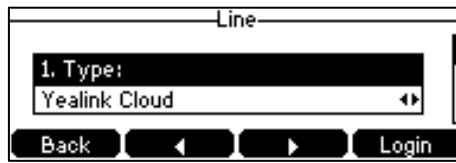

- Press the ◀ or ▶ soft key to select **PIN Code** from the **Login Type** field.
- Enter the PIN code (9-digit) in the **PIN Code** field.

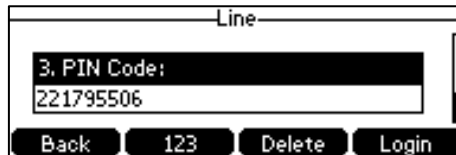

- Press the **Login** soft key.

### Note

If you fail to register a Yealink Cloud account by using PIN code, you can re-enter the PIN code according to the prompt or contact your Cloud enterprise administrator.

The PIN code can be used once only. You can contact your Cloud enterprise administrator to get a new PIN code.

## Account

### To register a Yealink Cloud account by using an account:

- Press **Menu->Settings->Advanced Settings** (default password: admin) -> **Accounts**.
- Press the **Enter** soft key.
- Press the ◀ or ▶ soft key to select **Yealink Cloud** from the **Type** field.

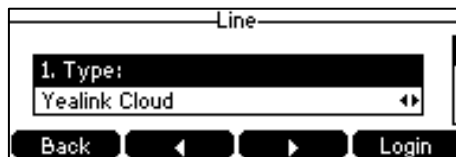

- Press the ◀ or ▶ soft key to select **Account** from the **Login Type** field.
- Enter the username (Cloud number) in the **User Name** field.
- Enter the password in the **Password** field.

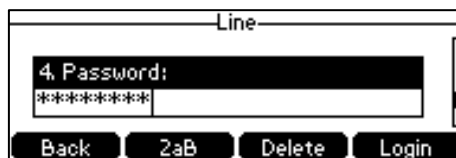

- (Optional.) Press the ◀ or ▶ soft key to select the desired value from the **Save Password** field.

- Press the **Login** soft key.

**Note**

If you fail to register a Yealink Cloud account by using an account, you can re-enter the account information according to the prompt or contact your Cloud enterprise administrator.

### Yealink Cloud Account Exit

**To exit the Yealink Cloud account:**

- Press **Menu->Settings->Advanced Settings** (default password: admin) ->**Accounts**.
- Select the Yealink Cloud account and then press the **Enter** soft key.
- Press the ◀ or ▶ soft key to select **Yealink Cloud** from the **Type** field.
- Press the **Logout** soft key.

The LCD screen prompts the following warning:



- Press the **OK** soft key.

### Dial Plan

Dial plan is a string of characters that governs the way your CP860 IP conference phone processes the inputs received from your phone keypad. The CP860 IP conference phone supports the following dial plan features:

- [Replace Rule](#)
- [Dial Now](#)
- [Area Code](#)
- [Block Out](#)

The basic expression syntaxes you need to know:

.	The dot "." can be used as a placeholder or multiple placeholders for any character. Example: "12." would match "123", "1234", "12345", "12abc", etc.
x	An "x" can be used as a placeholder for any character. Example: "12x" would match "121", "122", "123", "12a", etc.
-	Numeric ranges are allowed within the brackets: Digit "-" Digit. Example: "[5-7]" would match the number "5", "6" or "7".
[]	The square brackets "[]" can be used as a placeholder for a single character

	which matches any of a set of characters. Example: "91[5-7]1234" would match "91 <b>5</b> 1234", "91 <b>6</b> 1234", "91 <b>7</b> 1234".
()	The parentheses "(" and ")" can be used to group together patterns, for instance, to logically combine two or more patterns. Example: "([1-9])([2-7])3" would match " <b>923</b> ", " <b>153</b> ", " <b>773</b> ", etc.
\$	The "\$" should be followed by the sequence number of a parenthesis. The "\$" plus the sequence number means the whole character or characters placed in the parenthesis. The number directs to the right parenthesis when there are more than one. Example: A replace rule configuration: Prefix: "9([5-7])(.)", Replace: "5\$2". When you enter "96123" to dial out on your phone, the number will be replaced as " <b>5123</b> " and then dialed out. "\$2" means the characters in the second parenthesis, that is, "123".

**Note**

The IP phone supports a new dial plan mechanism - digit map. Digit maps are defined by a single string or a list of strings. If a number you dial matches any string of a digit map, the call is automatically placed.

Note that if digit map feature is enabled, the old dial plan rules (described in this chapter) will be ignored. For more information, contact your system administrator.

## Replace Rule

You can configure one or more replace rules (up to 100) to remove the specified string and replace it with another string. You can configure a pattern with wildcards (expression syntax refer to the table above), so that any string that matches the pattern will be replaced. This feature is convenient for you to dial out a long number. For example, a replace rule is configured as "Prefix: 1" and "Replace: 1234567", when you try to dial out the number "1234567", you just need to enter "1" on the phone and then press the **Send** soft key.

**To add a replace rule via web user interface:**

1. Click on **Settings->Dial Plan->Replace Rule**.
2. Enter the string (e.g., 1) in the **Prefix** field.

3. Enter the string (e.g., 1234567) in the **Replace** field.

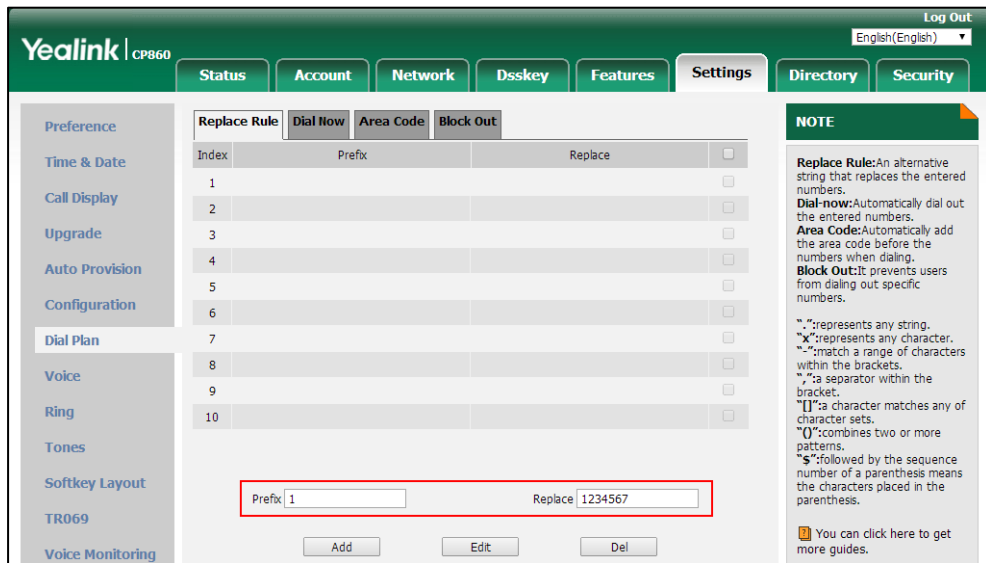

4. Click **Add** to add the replace rule.

When you enter the number “1” using the keypad and then press the **Send** soft key, the phone will dial out “1234567” instead.

**To edit a replace rule via web user interface:**

1. Click on **Settings->Dial Plan->Replace Rule**.
2. Select the desired replace rule by checking the checkbox.
3. Edit values in the **Prefix** and **Replace** fields.
4. Click **Edit** to accept the change.

**To delete one or more replace rules via web user interface:**

1. Click on **Settings->Dial Plan->Replace Rule**.
2. Select the one or more replace rules by checking the checkbox(es).
3. Click **Del** to delete the replace rule(s).

**Note** Replace rule is configurable via web user interface only.

## Dial Now

You can configure one or more dial now rules (up 100) on your phone. When the dialed number matches the dial now string, the number will be dialed out automatically. For example, a dial now rule is configured as "2xx", any entered three-digit string beginning with 2 will then be dialed out automatically on the phone.

**To add a dial now rule via web user interface:**

1. Click on **Settings->Dial Plan->Dial Now**.

- Enter the desired value (e.g., 2xx) in the **Rule** field.

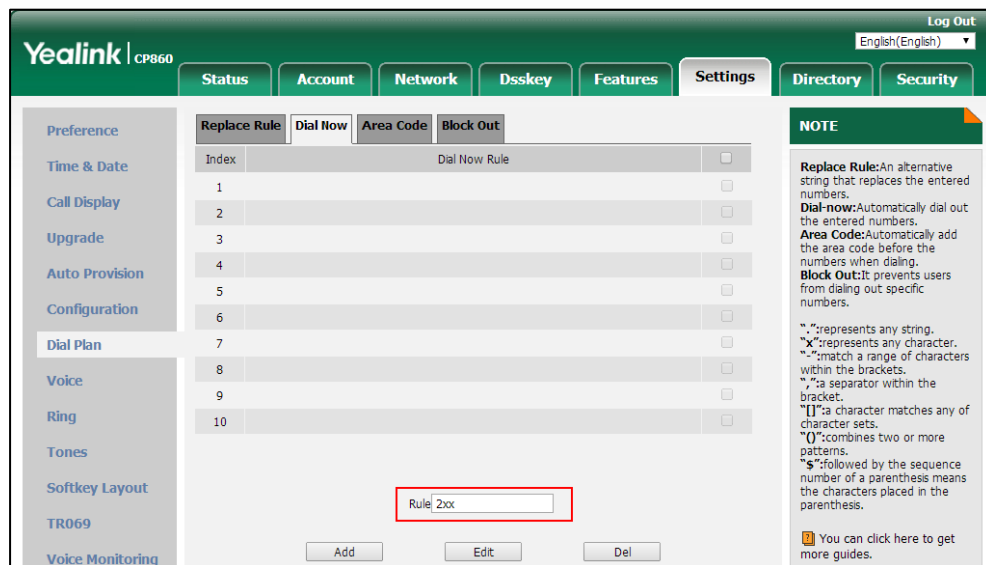

- Click **Add** to add the dial now rule.

When you enter the number “234” using the keypad, the phone will dial out “234” automatically without the pressing of any key.

#### Note

You can also edit or delete the dial now rule, refer to [Replace Rule](#) on page 63 for more information.

Dial now rule is configurable via web user interface only.

#### Time Out for Dial Now Rule

You can configure the interval for dial now rules. That is, you can configure your phone to automatically dial out the phone number which matches a dial now rule, after the designated period of time.

#### To configure the time out for dial now rule via web user interface:

- Click on **Features**->**General Information**.
- Enter the time between 0 and 14 (seconds) in the **Time Out for Dial Now Rule** field.

The default value is "1".

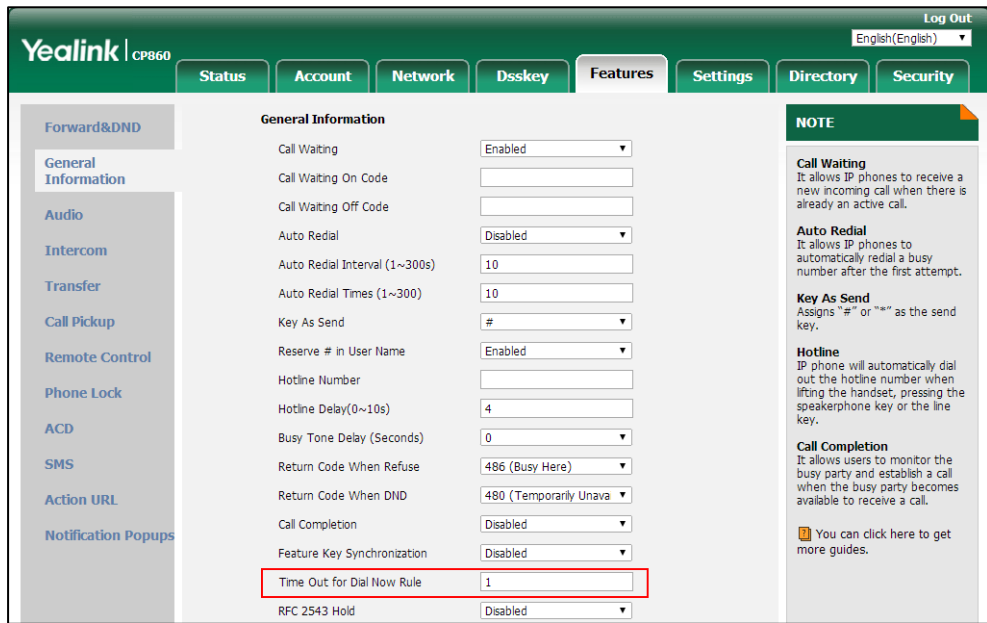

3. Click **Confirm** to accept the change.

**Note** Time out for dial now rule is configurable via web user interface only.

## Area Code

Area codes are also known as Numbering Plan Areas (NPAs). They usually indicate geographical areas in a country. This feature is necessary when dialing a phone number outside the code area. For example, an area code is configured as "Code: 0592, Min Length: 4, Max Length: 11". When you dial out the number "56789" (the length of the number is between 4 and 11), the phone will add the area code and dial out the number "059256789". You can only configure one area code rule on your phone.

**To configure the area code and lengths via web user interface:**

1. Click on **Settings->Dial Plan->Area Code**.
2. Enter the desired values in the **Code**, **Min Length (1-15)** and **Max Length (1-15)** fields.

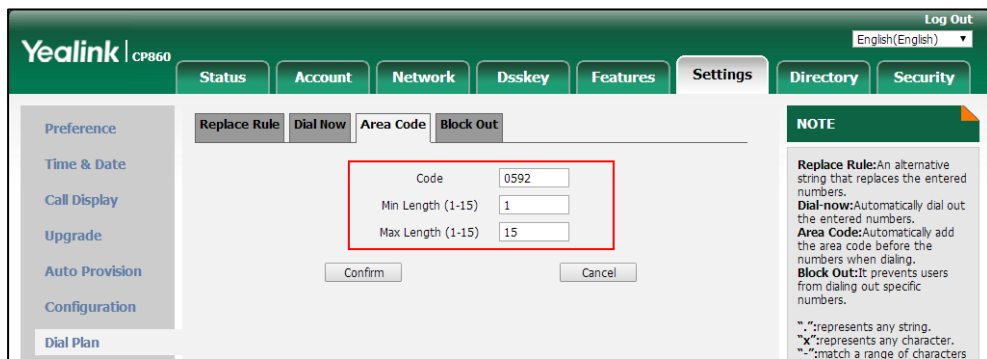

- Click **Confirm** to accept the change.

**Note** The default value of minimum and maximum length is 1 and 15 respectively.  
Area code is configurable via web user interface only.

## Block Out

You can block specific numbers (up to 10) from being dialed on your phone. When you dial a block out number on your phone, the dialing will fail and the LCD screen will prompt "Forbidden Number".

**To add a block out number via web user interface:**

- Click on **Settings->Dial Plan->Block Out**.
- Enter the desired value in the **BlockOut NumberX** field.

The screenshot shows the Yealink CP860 web interface. The 'Settings' menu is open, and the 'Block Out' sub-menu is selected. The 'Block Out' configuration page is displayed, showing a table with 10 rows for 'BlockOut Number1' through 'BlockOut Number10'. The 'BlockOut Number1' field is highlighted with a red box and contains the value '6543'. Below the table are 'Confirm' and 'Cancel' buttons. On the right side, there is a 'NOTE' section with the following text:

**Replace Rule:** An alternative string that replaces the entered numbers.  
**Dial Now:** Automatically dial out the entered numbers.  
**Area Code:** Automatically add the area code before the numbers when dialing.  
**Block Out:** It prevents users from dialing out specific numbers.

Special characters and their meanings:  
 ".": represents any string.  
 "x": represents any character.  
 "-": match a range of characters within the brackets.  
 ",": a separator within the bracket.  
 "[]": a character matches any of character sets.  
 "()": combines two or more patterns.  
 "\$": followed by the sequence

- Click **Confirm** to add the block out number.

**Note** Block out number is configurable via web user interface only.

## Emergency Number

Public telephone networks in countries around the world have a single emergency telephone number (emergency services number), that allows a caller to contact local emergency services for assistance when necessary. The emergency telephone number may differ from country to country. It is typically a three-digit number so that it can be easily remembered and dialed quickly. Some countries have a different emergency number for each of the different emergency services.

You can specify the emergency telephone numbers on the IP phone for contacting the emergency services in an emergency situation. You can dial emergency calls on the IP phone even when the phone keyboard is locked. For more information on phone lock, refer to [Phone](#)

[Lock](#) on page 30.

**Note**

Contact your local phone service provider for available emergency numbers in your area. The IP phone also supports the emergency dialplan, which allows users to make emergency calls if the phone is locked or unregistered. For more information, contact your system administrator.

**To specify emergency numbers via web user interface:**

1. Click on **Features**->**Phone Lock**.
2. Enter the emergency number in the **Emergency** field.

For multiple emergency numbers, enter a comma between every two numbers. The default emergency numbers are 112, 911 and 110.

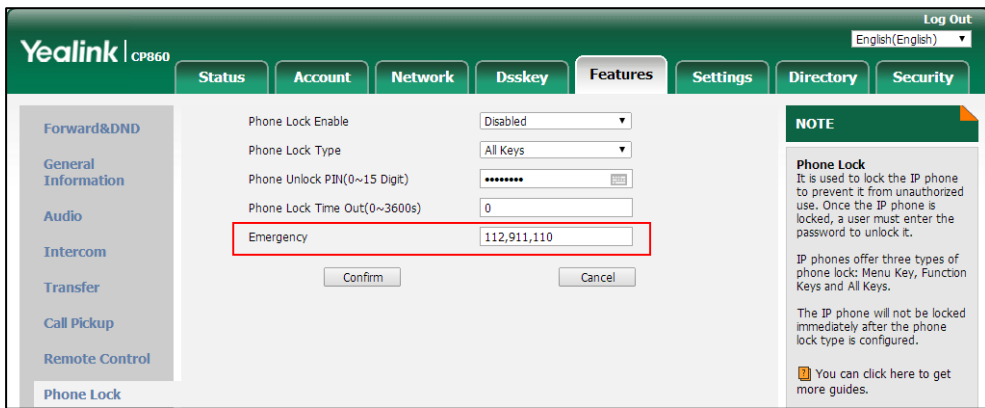

3. Click **Confirm** to accept the change.

**Note**

Emergency number is configurable via web user interface only.

## Live Dialpad

You can enable live dialpad on the CP860 IP conference phone, which enables the IP phone to automatically dial out a phone number without the pressing of the send key. You can also configure a delay, where the phone will dial out the phone number automatically after the designated period of time.

**To enable live dialpad via web user interface:**

1. Click on **Settings**->**Preference**.
2. Select **Enabled** from the pull-down list of **Live Dialpad**.
3. Enter the desired delay time in the **Inter Digit Time(1~14s)** field.



The default delay time is 4.

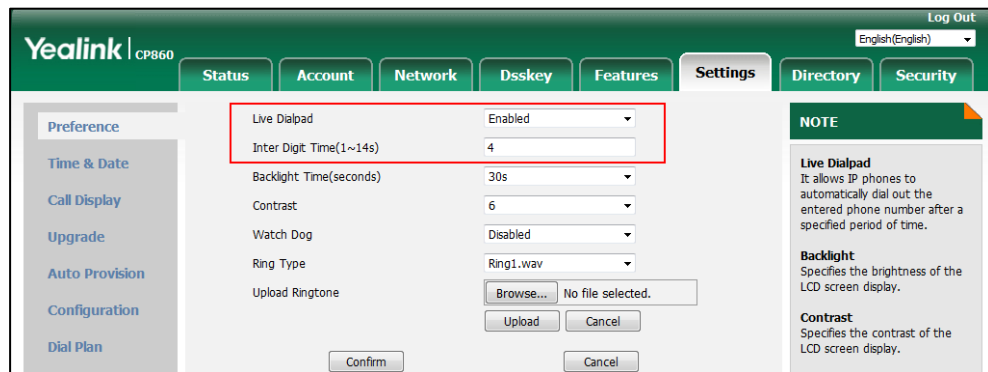

4. Click **Confirm** to accept the change.

**Note** Live dialpad is configurable via web user interface only.

## Hotline

You can dial a hotline number immediately upon pressing the off-hook key. You can also configure a delay, where the phone will dial out the hotline number automatically after the designated period of time.

**To configure the hotline number via phone user interface:**

1. Press **Menu**->**Features**->**Hot Line**.
2. Enter the desired number in the **Hotline Number** field.

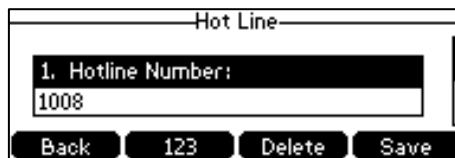

3. Enter the delay time (in seconds) in the **Hotline Delay** field.  
The valid values range from 0 to 10 (seconds) and the default value is "4".
4. Press the **Save** soft key to accept the change or the **Back** soft key to cancel.

Hotline is configurable via web user interface at the path **Features**->**General Information**.



# Using Your Phone with SIP/Cloud Account

---

## Basic Call Features

The CP860 IP conference phone is designed to be easily used like a regular phone on a public switched telephone network (PSTN). You can place calls, answer calls, transfer a call to someone else, or conduct a conference call.

This chapter provides basic operating instructions for the CP860 IP conference phone. Topics include:

- [Placing Calls](#)
- [Answering Calls](#)
- [Ending Calls](#)
- [Redialing Numbers](#)
- [Recent Call In Dialing](#)
- [Auto Answer](#)
- [Auto Redial](#)
- [Call Completion](#)
- [ReCall](#)
- [Call Mute](#)
- [Call Hold/Resume](#)
- [Do Not Disturb \(DND\)](#)
- [Call Forward](#)
- [Call Transfer](#)
- [Call Waiting](#)
- [Conference](#)
- [Call Pickup](#)
- [Anonymous Call](#)
- [Anonymous Call Rejection](#)

If you require additional information or assistance with your new phone, contact your system administrator.

## Placing Calls





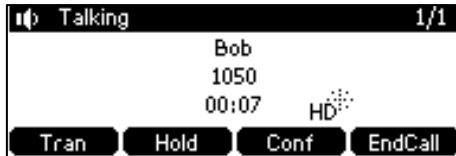

You can press the off-hook key either before or after entering the number to place a call. You can also dial an entry from local directory, favorite directory, remote phone book or call history. For more information, refer to [Contact Management](#) on page 35 and [Call History Management](#) on page 49.

The call duration and far-site's information (name and phone number) are visible on the LCD screen. In the figure below, the call to "Bob" (the phone number: 1050) has lasted 7 seconds.



### To place a call:

Do one of the following:

- Press  to obtain a dial tone.  
Enter the desired number using the keypad.  
Press , ,  or the **Send** soft key.
- Enter the desired number using the keypad.  
Press , ,  or the **Send** soft key.

The # key is configured as a send key by default. You can also set the \* key as the send key, or set neither. For more information, refer to the [Key As Send](#) on page 30.

### Note





You can also dial using the SIP URI or IP address. To obtain the IP address of a phone, press the **OK** key when the phone is idle. The maximum length of SIP URI or IP address length is 32 characters. For example, SIP URI: 3606@sip.com, IP: 192.168.1.15 or 192\*168\*1\*15.

Your phone may not support direct IP dialing. Contact your system administrator for more information.

The CP860 IP conference phone can handle multiple calls at a time. However, only one active call (the call that has audio associated with it) can be in progress at any given time.

### To place multiple calls:



You can have more than one call on your CP860 IP conference phone. To place a new call during an active call, do one of the following:

- Press . The active call is placed on hold.  
Enter the desired number using the keypad.  
Press , ,  or the **Send** soft key.
- Press the **Hold** soft key to place the original call on hold.

Press the **NewCall** soft key.

Enter the desired number using the keypad.

Press , ,  or the **Send** soft key.

You can press  or  to switch between calls, and then press the **Resume** soft key to retrieve the desired call.

## Answering Calls

You can answer a call no matter whether you are in another call or not. If you want to answer a new incoming call when in another call, ensure that call waiting has been enabled. For more information on call waiting, refer to [Call Waiting](#) on page 87.

### Note

You can ignore incoming calls by pressing the **Reject** soft key or on-hook key. You can also activate Do Not Disturb mode to ignore the incoming calls without ringing on your phone. For more information, refer to [Do Not Disturb \(DND\)](#) on page 81.



You can forward incoming calls to someone else by pressing the **FWD** soft key. For more information, refer to [Call Forward](#) on page 82.

### Answering When Not in Another Call

Call duration and destination will always appear on the LCD screen for the active call.



#### To answer a call:

Do one of the following:

- Press  .
- Press the **Answer** soft key.
- Press  .

### Answering When in Another Call

If you have an active call, and an incoming call arrives on the phone, do one of the following:

- Press the **Answer** soft key.  
The incoming call is answered and the original call is placed on hold.
- Press  to access the new call.  
Press ,  or the **Answer** soft key.  
The incoming call is answered and the original call is placed on hold.

## Ending Calls

### To end a call:

Do one of the following:

- Press the **EndCall** soft key.
- Press  .

### Note







To end a call placed on hold, you can press the **EndCall** soft key to end the call directly, or press the **Resume** soft key to resume the call before ending it.

## Redialing Numbers

### To redial the last dialed number from your phone:

1. Press  twice.  
A call to your last dialed number is attempted.

### To redial a previously dialed number from your phone:

1. Press  when the phone is idle.
2. Press  or  to select the desired entry from the placed calls list, and then press , ,  or the **Send** soft key.

## Recent Call In Dialing

To view the placed calls list when the phone is on the dialing screen, you should enable recent call in dialing in advance.

### To enable recent call in dialing via web user interface:

1. Click on **Directory->Setting**.

2. Select **Enabled** from the pull-down list of **Recent Call In Dialing**.

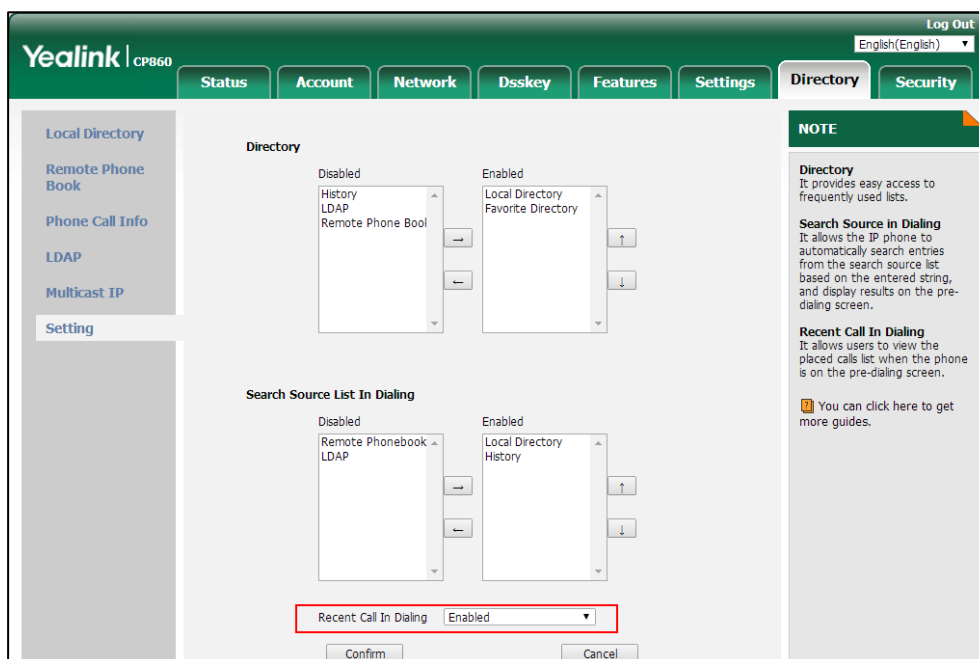

3. Click **Confirm** to accept the change.

**Note** Recent call in dialing is configurable via web user interface only.

### To view placed calls list when the phone is on the dialing screen:

1. Press .

The LCD screen displays the placed calls list.



You can also enter a few continuous characters of the contact name or continuous numbers of the contact number (office, mobile or other number) to search from placed calls list.



## Auto Answer

You can enable auto answer to automatically answer an incoming call. You can also enable auto answer mute to mute the local microphone when an incoming call is answered automatically.

**To configure auto answer and auto answer mute via phone user interface:**

1. Press **Menu->Features->Auto Answer**.
2. Press  to select **Status**, and then press the ◀ or ▶ soft key to select **Enabled** from the **Status** field.

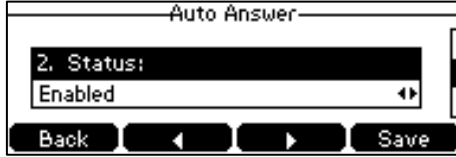

3. Press the ◀ or ▶ soft key to select **Enabled** from the **Auto Answer Mute** field.
4. Press the **Save** soft key to accept the change or the **Back** soft key to cancel.

The icon  appears on the LCD screen.



Auto answer is configurable via web user interface at the path **Account->Basic**.

**Note**

Auto answer is only applicable when there is no other call in progress on the phone.

## Auto Redial

You can enable auto redial to automatically redial a phone number when the called party is busy. You can also configure the number of auto redial attempts and the time to wait between redial attempts.

**To configure auto redial via phone user interface:**

1. Press **Menu->Features->Auto Redial**.
2. Press the ◀ or ▶ soft key to select **Enabled** from the **Auto Redial** field.

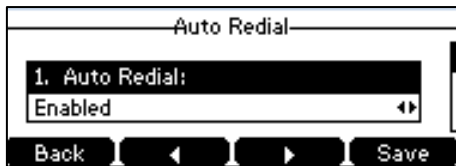

3. Enter the desired time (in seconds) in the **Redial Interval** field.  
The default time interval is "10".
4. Enter the desired number of redial attempts in the **Redial Times** field.  
The default value is "10".
5. Press the **Save** soft key to accept the change or the **Back** soft key to cancel.

Auto redial is configurable via web user interface at the path **Features->General Information**.



**To use auto redial:**

When the called party is busy, the LCD screen prompts the following:



1. Press the **OK** soft key to activate auto redial.

The LCD screen prompts the following:

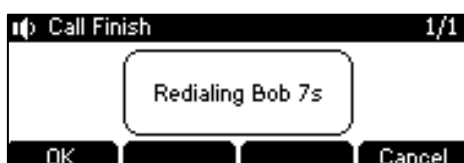

2. Wait for the designated period of time or press the **OK** soft key to redial the phone number.

The phone will retry as many times as configured until the called party is idle.

## Call Completion

You can use call completion to notify the caller who failed to reach a desired party when the party becomes available to receive a call.

**To configure call completion via phone user interface:**

1. Press **Menu->Features->Call Completion**.
2. Press the ◀ or ▶ soft key to select **Enabled** from the **Call Completion** field.

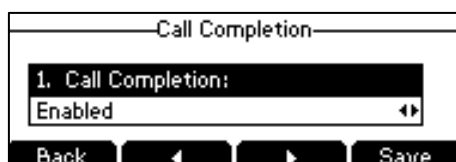

3. Press the **Save** soft key to accept the change or the **Back** soft key to cancel.

Call completion is configurable via web user interface at the path **Features->General Information**.

**To use call completion:**

When the called party is busy, the following prompt will appear on the LCD screen of the phone:

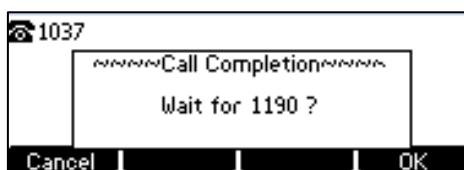

1. Press the **OK** soft key, the phone returns to the idle screen and call completion is activated. When the called party becomes idle, the following prompt will appear on the LCD screen of the phone:

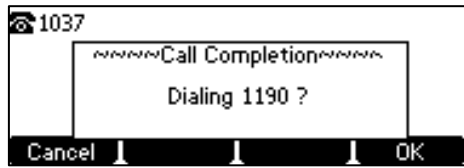

2. Press the **OK** soft key to redial the number.

**Note**

Call completion is not available on all servers. For more information, contact your system administrator.

## ReCall

You can press a recall key to place a call back to the last incoming call.

**To configure a recall key via web user interface:**

1. Click on **Dsskey->Programable Key**.
2. Select the desired programable key.
3. Select **ReCall** from the pull-down list of **Type**.

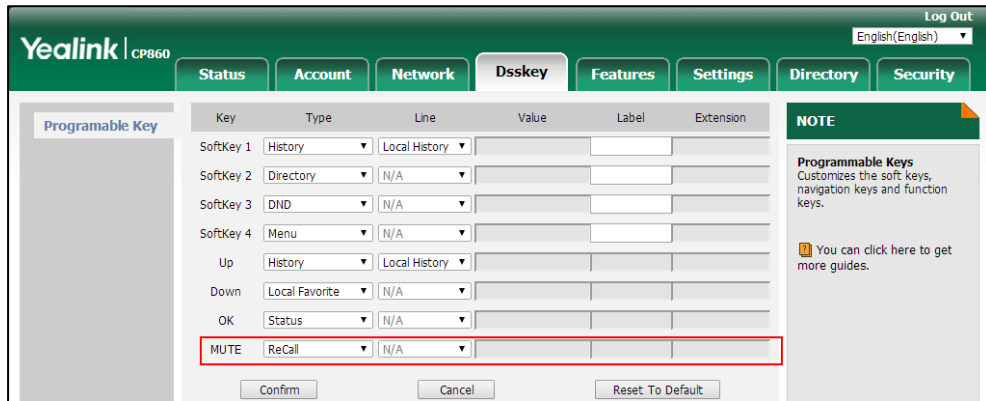

4. Click **Confirm** to accept the change.

**Note**

A recall key is configurable via web user interface only.

## Call Mute

You can mute the local microphone during an active call so that the other party cannot hear you, but you can still hear the other party. You can also mute the microphone while dialing so that the other party cannot hear you when the call is set up. It helps prevent the other party from hearing the informal discussion when auto answer is enabled on his/her phone.

## Keep Mute

Normally, the mute feature is deactivated when the active call ends. Keep mute feature enables you to make the mute state of your phone persist across calls. When keep mute is enabled and you press the MUTE key, the phone stays in the mute state until you un-mute the microphone or until the phone restarts. It helps prevent the other party from hearing the noise coming from your room when auto answer is enabled on your phone. When you mute the phone in an idle state or any other states, the icon  appears on the status bar.

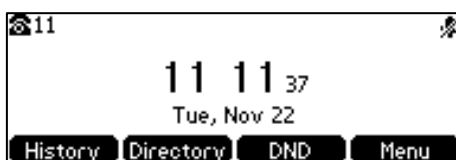

### Note

Keep mute feature should be pre-configured by your system administrator.

## Mute a Call

### To mute a call:



1. Press  during an active call.  
LED indicators illuminate solid red. The LCD screen indicates that the call is now muted.



### To un-mute a call:



1. Press  again to un-mute the call.

### To mute a call if you use expansion microphones:

1. Press  on the phone or tap  on the top of the expansion microphone during an active call.

LED indicators on the phone and the mute indicator LED on the expansion microphone illuminate solid red.

### To un-mute a call:

1. Press  on the phone or tap  on the top of the expansion microphone again to un-mute the call.

## Mute While Dialing

### To mute the microphone while dialing:

1. Press  on the pre-dialing or dialing screen.

The call is muted automatically when set up successfully.

**To un-mute the microphone while dialing:**

1. Press  again on the pre-dialing or dialing screen.

**Note**

You can also mute the microphone when the IP phone is ringing.

## Call Hold/Resume

You can place an active call on hold. Only one active call can be in progress at any time. Other calls can be made and received while placing the original call on hold. When you place a call on hold, your IP PBX may play music on hold to the other party while waiting.

**To place a call on hold:**

1. Press the **Hold** soft key during a call.

LED indicators flash green. The LCD screen indicates that the call is on hold.



**Note**



The phone will beep softly every 30 seconds to remind you that you still have a call on hold.

**To resume a held call:**

1. Press the **Resume** soft key.

**Multiple Calls on Hold:**

If multiple calls are placed on hold:

1. Press  or  to switch between the calls, and then press the **Resume** soft key to retrieve the desired call.

If more than one call is placed on hold, a numbered prompt appears on the LCD screen, for example "2/3", indicating that this is the second call out of three calls.

## Do Not Disturb (DND)

You can use DND to reject incoming calls automatically on the phone. The prompt message "**n New Missed Call(s)**" ("n" indicates the number of missed calls, e.g., 1 New Missed Call(s)) will appear on the LCD screen, and callers will receive a busy message. All calls you receive while DND is activated are logged to your missed calls list.

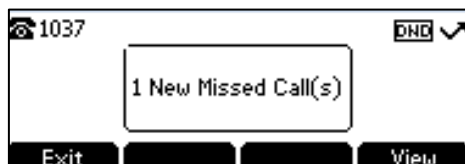

### Note

The prompt message will display only if Missed Call Log is enabled. Missed call log is configurable via web user interface at the path **Account->Basic**.

Do not disturb is local to the phone, and may be overridden by the server settings. For more information, contact your system administrator.

When DND feature is activated, the IP phone supports displaying a large DND icon on the idle screen. For more information, contact your system administrator.



### To activate DND via phone user interface:

1. Press the **DND** soft key when the phone is idle.

The icon  appears on the status bar.

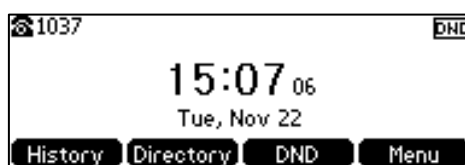

### Note

When DND and busy forward are activated, calls will be sent to the configured destination number. For more information on busy forward, refer to [Call Forward](#) on page 82.

DND is configurable via web user interface at the path **Features->Forward&DND**.

### To configure the DND authorized numbers via web user interface:

1. Click on **Features->Forward&DND**.
2. Select **Enabled** from the pull-down list of **DND Emergency**.
3. Enter the numbers in the **DND Authorized Numbers** field.

For multiple numbers, enter a comma between every two numbers.

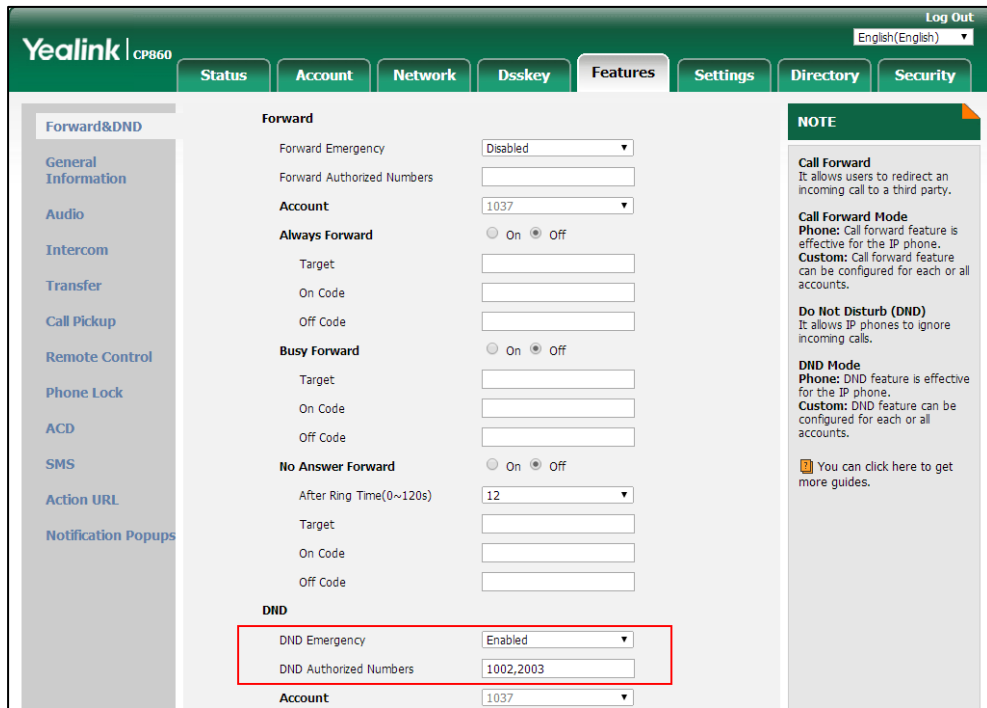

4. Click **Confirm** to accept the change.

When DND is activated on the phone, the phone can still receive incoming calls from the numbers specified in the **DND Authorized Numbers** field.

**Note**

DND authorized number is configurable via web user interface only.  
 When the phone misses a call, a prompt window will pop up by default, if you want to disable the feature, contact your system administrator for more information.

**To deactivate DND via phone user interface:**

1. Press the **DND** soft key when the phone is idle.

## Call Forward

You can configure your phone to forward incoming calls to another party (static forwarding). You can also forward calls while your phone is ringing (dynamic forwarding).

**Note**



When the phone forwards a call, a prompt window will pop up by default. If you want to disable the feature, contact your system administrator for more information.

## Static Forwarding

Three types of static forwarding are:

- **Always Forward:** Incoming calls are immediately forwarded.
- **Busy Forward:** Incoming calls are immediately forwarded if the phone is busy.
- **No Answer Forward:** Incoming calls are forwarded if not answered after a period of time.

**To activate call forward via phone user interface:**

1. Press **Menu->Features->Call Forward**.
2. Press  or  to select the desired forwarding type, and then press the **Enter** soft key.
3. Depending on your selection:

a) If you select **Always Forward:**

- 1) Press the  or  soft key to select **Enabled** from the **Always Forward** field.

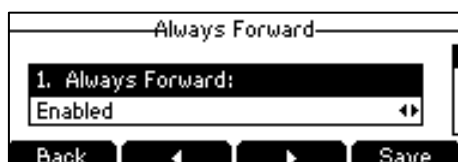

- 2) Enter the destination number you want to forward all incoming calls to in the **Forward to** field.
- 3) (Optional.) Enter the always forward on code or off code respectively in the **On Code** or **Off Code** field.

b) If you select **Busy Forward:**

- 1) Press the  or  soft key to select **Enabled** from the **Busy Forward** field.

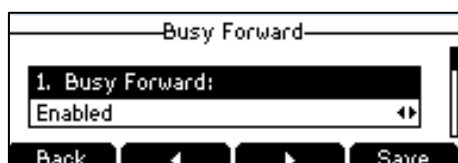

- 2) Enter the destination number you want to forward all incoming calls to when the phone is busy in the **Forward to** field.
- 3) (Optional.) Enter the busy forward on code or off code respectively in the **On Code** or **Off Code** field.

c) If you select **No Answer Forward:**

- 1) Press the  or  soft key to select **Enabled** from the **No Answer Forward** field.

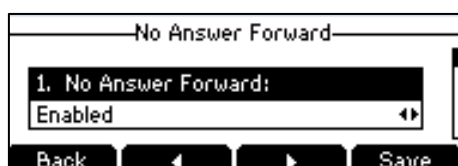

- 2) Enter the destination number you want to forward all unanswered incoming calls

to in the **Forward to** field.

- 3) Press the ◀ or ▶ soft key to select the ring time to wait before forwarding from the **After Ring Time** field.

The default ring time is 12 seconds.

- 4) (Optional.) Enter the no answer forward on code or off code respectively in the **On Code** or **Off Code** field.

4. Press the **Save** soft key to accept the change or the **Back** soft key to cancel.

The icon  on the idle screen indicates that the call forward is activated.

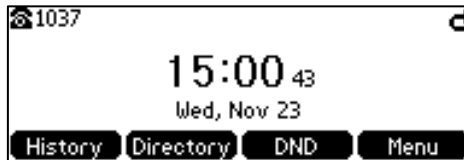

Call forward is configurable via web user interface at the path **Features->Forward&DND**.

**Note**

You can also enter the SIP URL or IP address in the **Forward to** field. For more information on using the SIP URL or IP address, refer to [Placing Calls](#) on page 72.

Call forward is local to the phone, and may be overridden by the server settings. Call forward on code or off code may be different between servers. For more information, contact your system administrator.

**To configure the forward authorized numbers via web user interface:**

1. Click on **Features->Forward&DND**.
2. Select **Enabled** from the pull-down list of **Forward Emergency**.
3. Enter the numbers in the **Forward Authorized Numbers** field.

For multiple numbers, enter a comma between every two numbers.

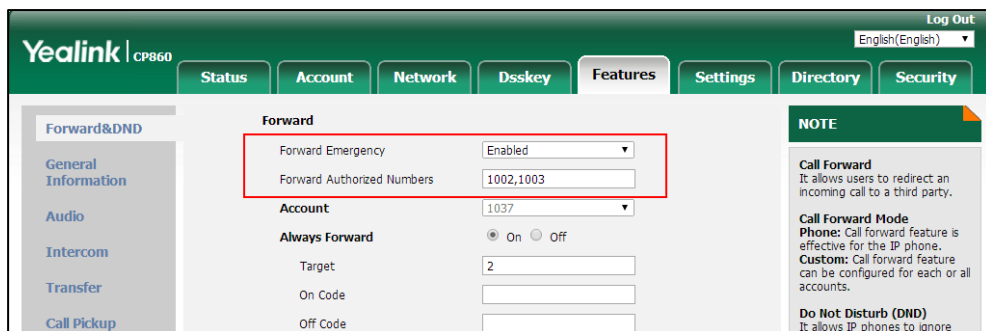

4. Click **Confirm** to accept the change.





When call forward is activated on the phone, the phone cannot forward incoming calls from the numbers specified in the **Forward Authorized Numbers** field.

**Note**

Forward authorized number is configurable via web user interface only.



**To deactivate call forward via phone user interface:**

1. Press **Menu->Features->Call Forward**.
2. Press  or  to select the desired forwarding type, and then press the **Enter** soft key.
3. Press the  or  soft key to select **Disabled** to deactivate the call forward.
4. Press the **Save** soft key to accept the change.

## Dynamic Forwarding

**To forward an incoming call to another party:**

1. When the phone is ringing, press the **FWD** soft key.
2. Enter the number you want to forward the incoming call to.



3. Press , ,  or the **Send** soft key.

The LCD screen prompts a call forward message.

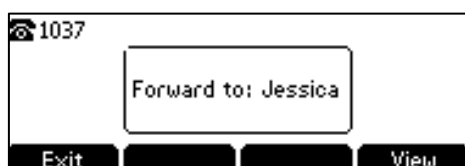

## Call Transfer

You can transfer a call to another party in one of three ways:

- **Blind Transfer:** Transfer a call directly to another party without consulting.
- **Semi-Attended Transfer:** Transfer a call when the target phone is ringing.
- **Attended Transfer (Consultative Transfer):** Transfer a call with prior consulting.

**To perform a blind transfer:**





1. Press the **Tran** soft key during a call.
2. Enter the number you want to transfer the call to.







3. Press the **Tran** soft key to complete the transfer.

Then the call is connected to the number to which you are transferring.

**To perform a semi-attended transfer:**

1. Press the **Tran** soft key during a call.
2. Do one of the following:
  - Enter the number you want to transfer the call to.
  - Press the **Directory** soft key, and then select **Local Directory**. Select the desired group and search for the contact (Directory should be configured in advance. Refer to [Directory](#) on page 36 for more information).
  - Press the **Directory** soft key, and then select **Favorite Directory**. Select the desired contact and search for the contact (Directory should be configured in advance. Refer to [Directory](#) on page 36 for more information).
  - Press the **Directory** soft key, and then select **History**. Select the desired list and then press  or  to select the entry (Directory should be configured in advance. Refer to [Directory](#) on page 36 for more information).
  - Press the **Directory** soft key, and then select **Remote Phone Book**. Select the desired group and search for the contact (Directory and Remote Phone Book should be configured in advance. Refer to [Directory](#) on page 36 and [Remote Phone Book](#) on page 48 for more information).
3. Press ,  or  to dial out.
4. Press the **Tran** soft key to complete the transfer when receiving ringback.

**To perform an attended transfer:**

1. Press the **Tran** soft key during a call.
2. Do one of the following:
  - Enter the number you want to transfer the call to.
  - Press the **Directory** soft key, and then select **Local Directory**. Select the desired group and search for the contact (Directory should be configured in advance. Refer to [Directory](#) on page 36 for more information).
  - Press the **Directory** soft key, and then select **Favorite Directory**. Select the desired contact and search for the contact (Directory should be configured in advance. Refer to [Directory](#) on page 36 for more information).
  - Press the **Directory** soft key, and then select **History**. Select the desired list and then press  or  to select the entry (Directory should be configured in advance. Refer to [Directory](#) on page 36 for more information).
  - Press the **Directory** soft key, and then select **Remote Phone Book**. Select the desired group and search for the contact (Directory and Remote Phone Book should be configured in advance. Refer to [Directory](#) on page 36 and [Remote Phone Book](#) on page 48 for more information).
3. Press ,  or  to dial out.

4. After the party answers the call, press the **Tran** soft key to complete the transfer.

You can cancel the transfer before the call is connected by pressing the **Cancel** soft key.

## Call Waiting

You can enable or disable call waiting on the phone. If call waiting is enabled, you can receive another call while there is already an active call on the phone. Otherwise, another incoming call is automatically rejected by the phone with a busy message when there is an active call on the phone. You can also enable or disable the phone to play a warning tone when receiving another call.

### To configure call waiting via phone user interface:

1. Press **Menu->Features->Call Waiting**.
2. Press the ◀ or ▶ soft key to select **Enabled** from the **Call Waiting** field.

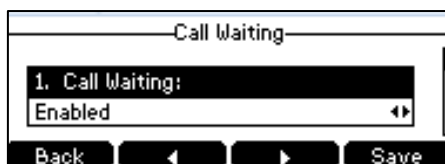

3. Press the ◀ or ▶ soft key to select **Enabled** from the **Play Tone** field.
4. (Optional.) Enter the call waiting on code or off code respectively in the **On Code** or **Off Code** field.
5. Press the **Save** soft key to accept the change or the **Back** soft key to cancel.

Call waiting is configurable via web user interface at the path **Features->General Information**.

## Conference

You can create a conference with other four parties using the phone's local conference. You can view and manage each participant in the conference call. The CP860 IP conference phone also supports network conference. The network conference URI should be predefined, contact your system administrator for more information.

### Note



Network conference is not available on all servers. For more information, contact your system administrator.

## Local Conference

The CP860 IP conference phone supports up to five parties (including yourself) in a conference call. The default conference type is Local Conference.

### To set up a three-way local conference call:



1. Place a call to the first party.

2. When the first party answers the call, press the **Conf** soft key to place a new call.  
The active call is placed on hold.
3. Enter the number of the second party and then press , ,  or the **Send** soft key.
4. When the second party answers the call, press the **Conf** soft key again to join all parties in the conference.





You can create a conference between an active call and a call on hold by pressing the the **Conf** soft key.





**To set up a conference call with an active call and a call on hold:**

1. Establish two calls on the phone.
2. Press  or  to select an active call.
3. Press the **Conf** soft key to join the two calls in the conference.

**To join more parties in an established conference call:**

1. Press the **Conf** soft key after the conference call is established.
2. Enter the number of the new party and then press , ,  or the **Send** soft key.
3. Press the **Conf** soft key when the party answers.
4. Repeat steps 1 to 3 to join more parties in the established conference call.

**During the conference call, you can do the following:**

- Press the **Hold** soft key to place the conference on hold.
- Press the **Conf** soft key to join more parties in an established conference call.
- Press the **Manage** soft key, and then press  or  to select the desired party:
  - Press the **FarMute** soft key to mute the party. The muted party can hear everyone, but no one can hear the muted party.
  - Press the **Remove** soft key to remove the selected party from the conference call.
  - Press the **All Split** soft key to split the conference call into individual calls on hold.
  - Press the **Back** soft key to return to the previous screen.
- Press  to mute the conference call, all other participants can hear each other, but they cannot hear you.
- Press  or the **EndCall** soft key to drop the conference call.

## Network Conference

You can use network conference on the CP860 IP conference phone to conduct a conference with multiple participants.

This feature allows you to perform the following:

- Join two calls together into a conference call.
- Invite another party into an active conference call.
- Remove a specific conference party.

To use this feature, contact your system administrator for the network conference URI in advance.

### To configure network conference via web user interface:

1. Click on **Account**->**Advanced**.
2. Select **Network Conference** from the pull-down list of **Conference Type**.
3. Enter the conference URI (e.g., conference@example.com) in the **Conference URI** field.

The screenshot shows the Yealink CP860 web user interface. The 'Account' tab is selected, and the 'Advanced' sub-tab is active. The 'Conference Type' dropdown is set to 'Network Conference' and the 'Conference URI' text field contains 'conference@example.com'. A red rectangular box highlights these two fields. Other settings visible include 'Keep Alive Type' (Default), 'Keep Alive Interval' (30), 'RPort' (Disabled), 'Subscribe Period' (1800), 'DTMF Type' (RFC2833), 'DTMF Info Type' (DTMF-Relay), and 'DTMF Payload Type' (101). The 'NOTE' section on the right provides additional information about various features.

4. Click **Confirm** to accept the change.



### Note

Network conference is configurable via web user interface only.



### To set up a network conference call:

1. Place a call to the first party.
2. Press the **Conf** soft key to place a new call.

The active call is placed on hold.

3. Enter the number of the second party and then press  ,  ,  or the **Send** soft

key.

4. When the second party answers the call, press the **Conf** soft key to add the second party to the conference.
5. Press the **Conf** soft key to place a new call.  
The conference is placed on hold.
6. Enter the number of the new party and then press , ,  or the **Send** soft key.
7. When the new party answers the call, press the **Conf** soft key to add the new party to the conference.
8. Repeat steps 5 to 7 until you have added all intended parties.

The procedures to set up a network conference call on specific servers may be different from that introduced above. Contact your system administrator for more information.

## Call Park

You can use call park feature to place a call on hold, and then retrieve the call from another phone in the system (for example, a phone in another office or conference room). You can park an active call by pressing the **Park** soft key on the phone. If the call is parked successfully, there is a voice prompt confirming that the call was parked. You can retrieve the parked call by pressing the **Retrieve** soft key. If the parked call is not retrieved within a period of time defined by the system, the phone performing call park will receive the call back.

**Note** Call park is not available on all servers. Contact your system administrator for more information.

The IP phone supports call park feature under the following modes:

- **FAC mode:** park the call to the local extension or a desired extension through dialing the park code.
- **Transfer mode:** park the call to shared parking lot through performing a blind transfer to a call park number (call park code).

You can select to use any of above modes according to your server.

**Note** The call park code and park retrieve code are predefined on the system server. Contact your system administrator for more information.

## FAC Mode

**To configure call park feature in FAC mode via web user interface:**

1. Click on **Features->Call Pickup**.
2. Select **FAC** from the pull-down list of **Call Park Mode**.
3. Select **Enabled** from the pull-down list of **Call Park**.

If **Enabled** is selected, the **Park** soft key will display on the LCD screen during a call, and the **Retrieve** soft key will display on the dialing screen.

4. (Optional.) Enter the call park code in the **Call Park Code** field.  
It is configured for the **Park** soft key.
5. (Optional.) Enter the park retrieve code in the **Park Retrieve Code** field.  
It is configured for the **Retrieve** soft key.

The screenshot shows the Yealink CP860 web interface. The 'Call Park' section is highlighted with a red box. The configuration is as follows:

Field	Value
Directed Call Pickup	Disabled
Directed Call Pickup Code	
Group Call Pickup	Disabled
Group Call Pickup Code	
<b>Call Park Mode</b>	<b>FAC</b>
<b>Call Park</b>	<b>Enabled</b>
<b>Call Park Code</b>	<b>*68</b>
<b>Park Retrieve Code</b>	<b>*88</b>

The 'NOTE' sidebar on the right contains the following information:

- Directed Call Pickup**: Picks up an incoming call on a specific extension.
- Directed Call Pickup**: Picks up incoming calls within a pre-defined group.
- You can configure directed/group call pickup feature for the IP phone.
- Visual Alert for BLF Pickup**: It allows the supervisor's phone to display a visual prompt when the monitored user receives an incoming call.
- Audio Alert for BLF Pickup**: It allows the supervisor's phone to play an alert tone when the

6. Click **Confirm** to accept the change.

**Note** If the **Park** or **Retrieve** soft key doesn't appear on the LCD screen, please select **Disabled** from the pull-down list of **Custom Softkey** via web user interface at path **Settings->Softkey Layout**.

#### To park a call in FAC mode:

1. During a call, press the **Park** soft key (You may need to press the **More** soft key to see the **Park** soft key).
  - If the call park code is not configured, you need to enter the call park code.





Press **OK**, **#SEND** or the **Park** soft key.

- If the call park code is configured, the phone will dial the configured call park code shown as below:



2. Do one of the following:

- a) If you want to park the call against the local extension.
  - 1) Press  .  
If the call is parked successfully, you will hear a voice prompt confirming that the call is parked.
- b) If you want to park the call against desired extension.
  - 1) Enter an extension (e.g., 4605) where you want to park the call.
  - 2) Press  or  .  
If the call is parked successfully, you will hear a voice prompt confirming that the call is parked. The call is parked against the extension you entered.

**To retrieve a parked call in FAC mode:**

1. Do one of the following:
  - If the park retrieve code is not configured, dial the park retrieve code (e.g., \*88).
  - If the park retrieve code is configured, press the **Retrieve** soft key on the dialing screen.

The phone will dial the configured park retrieve code and the Retrieve screen appears as below:

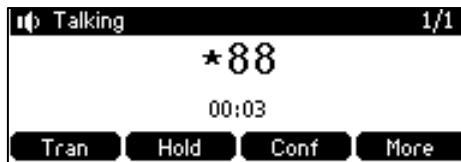

2. Follow the voice prompt, do one of the following:
  - Press  on the phone where the call is parked.
  - Enter the desired extension followed by # (e.g., 4605#) on any phone.

## Transfer Mode

**To configure call park feature in transfer mode via web user interface:**

1. Click on **Features->Call Pickup**.
2. Select **Transfer** from the pull-down list of **Call Park Mode**.
3. Select **Enabled** from the pull-down list of **Call Park**.  
If **Enabled** is selected, the **Park** soft key will display on the LCD screen during a call, and the **Retrieve** soft key will display on the dialing screen.
4. (Optional.) Enter the call park code in the **Call Park Code** field.  
It is configured for the **Park** soft key.
5. (Optional.) Enter the park retrieve code in the **Park Retrieve Code** field.



It is configured for the **Retrieve** soft key.

The screenshot shows the Yealink CP860 web interface. The 'Features' tab is selected, and the 'Call Pickup' section is expanded. Under 'Call Park', the 'Call Park Mode' is set to 'Transfer' and 'Call Park' is set to 'Enabled'. The 'Call Park Code' is '\*01' and the 'Park Retrieve Code' is '\*11'. A red box highlights the 'Call Park Mode' and 'Call Park' settings. A 'NOTE' box on the right explains the features: 'Directed Call Pickup' (picks up an incoming call on a specific extension), 'Directed Call Pickup' (picks up incoming calls within a pre-defined group), 'Visual Alert for BLF Pickup' (allows the supervisor's phone to display a visual prompt), and 'Audio Alert for BLF Pickup' (allows the supervisor's phone to play an alert tone).

- Click **Confirm** to accept the change.

**Note** If the **Park** or **Retrieve** soft key doesn't appear on the LCD screen, please select **Disabled** from the pull-down list of **Custom Softkey** via web user interface at path **Settings->Softkey Layout**.

#### To park a call in Transfer mode:

- During a call, press the **Park** soft key (You may need to press the **More** soft key to see the **Park** soft key).
  - If the call park code is not configured, you need to enter the call park code (e.g., \*01).



Press **OK**, **#END** or the **Park** soft key. The call will be transferred to the shared parking lot.

- If the call park code is configured, the call will be directly transferred to the shared parking lot.

**Note** For some servers, the system will return a specific call park retrieve number (park retrieve code) from which the call can be retrieved after parking successfully.

#### To retrieve a parked call in Transfer mode:

- Do one of the following:

- If the park retrieve code is not configured, dial the park retrieve code (e.g., \*11).



- If the park retrieve code is configured, press the **Retrieve** soft key on the dialing screen.

The phone will retrieve the parked call from the shared parking lot.

## Call Pickup

You can use call pickup to answer someone else’s incoming call on your phone. The CP860 IP conference phone supports directed call pickup and group call pickup. Directed call pickup is used for picking up a call that is ringing at a target phone number. Group call pickup is used for picking up a call that is ringing at any phone number in a certain group. The pickup group should be predefined, contact your system administrator for more information.

You can pick up an incoming call by using the **DPickup/GPickup** soft key. To use call pickup, you need to configure the call pickup code beforehand via web user interface.

**Note**

If there are many incoming calls at the same time, pressing the **GPickup** soft key on the phone will pick up the call that rings first.

### Directed Call Pickup

**To enable directed call pickup and configure the directed call pickup code via web user interface:**

1. Click on **Features**->**Call Pickup**.
2. Select **Enabled** from the pull-down list of **Directed Call Pickup**.
3. Enter the directed call pickup code in the **Directed Call Pickup Code** field.

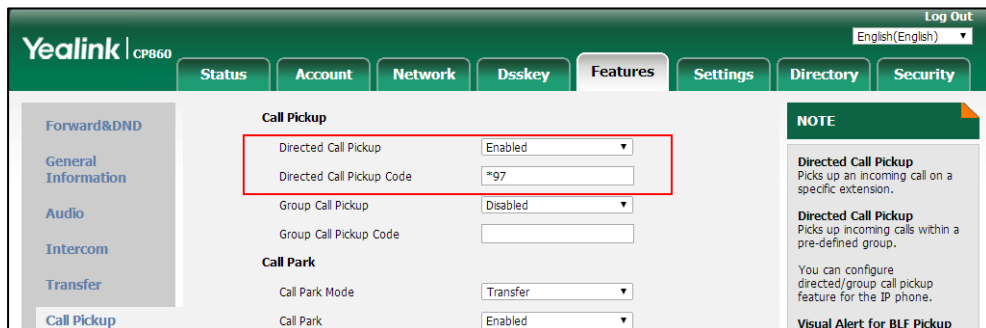

4. Click **Confirm** to accept the change.

**To configure the directed call pickup code on a per-line basis via web user interface:**

1. Click on **Account**->**Advanced**.

- Enter the directed call pickup code in the **Directed Call Pickup Code** field.

The screenshot shows the Yealink CP860 web interface. The 'Account' tab is selected. The 'Directed Call Pickup Code' field is highlighted with a red box and contains the value '\*97'. Other settings include Keep Alive Type (Default), Keep Alive Interval (30), RPort (Disabled), Subscribe Period (1800), DTMF Type (RFC2833), DTMF Info Type (DTMF-Relay), and DTMF Payload Type (101). A 'NOTE' section on the right provides information about DTMF, Session Timer, Busy Lamp Field/BLF List, Shared Call Appearance (SCA)/ Bridge Line Appearance (BLA), and Network Conference.

- Click **Confirm** to accept the change.

#### To pick up a call directly:

- Press .

The **DPickup** soft key appears on the LCD screen (You may need to press the **More** soft key).



- Press the **DPickup** soft key on your phone when the target phone receives an incoming call.
- Enter the phone number which is receiving an incoming call.
- Press the **DPickup** soft key again.

The call is answered on your phone.

### Group Call Pickup

#### To enable group call pickup and configure the group call pickup code via web user interface:

- Click on **Features->Call Pickup**.
- Select **Enabled** from the pull-down list of **Group Call Pickup**.

- Enter the group call pickup code in the **Group Call Pickup Code** field.

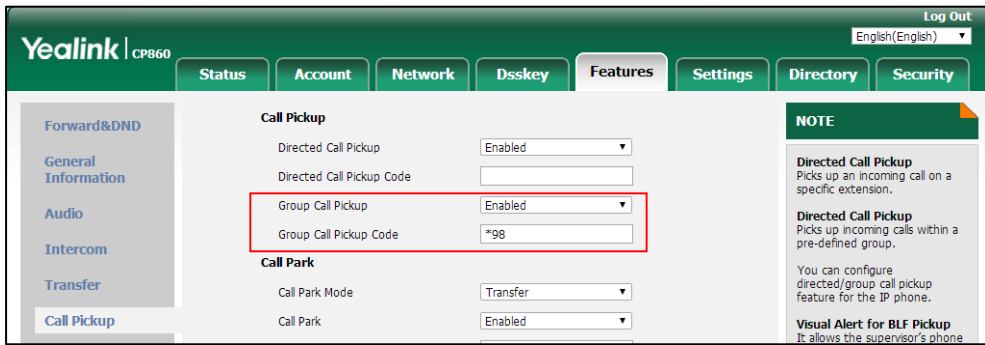

- Click **Confirm** to accept the change.

**To configure the group call pickup code on a per-line basis via web user interface:**

- Click on **Account->Advanced**.
- Enter the group call pickup code in the **Group Call Pickup Code** field.

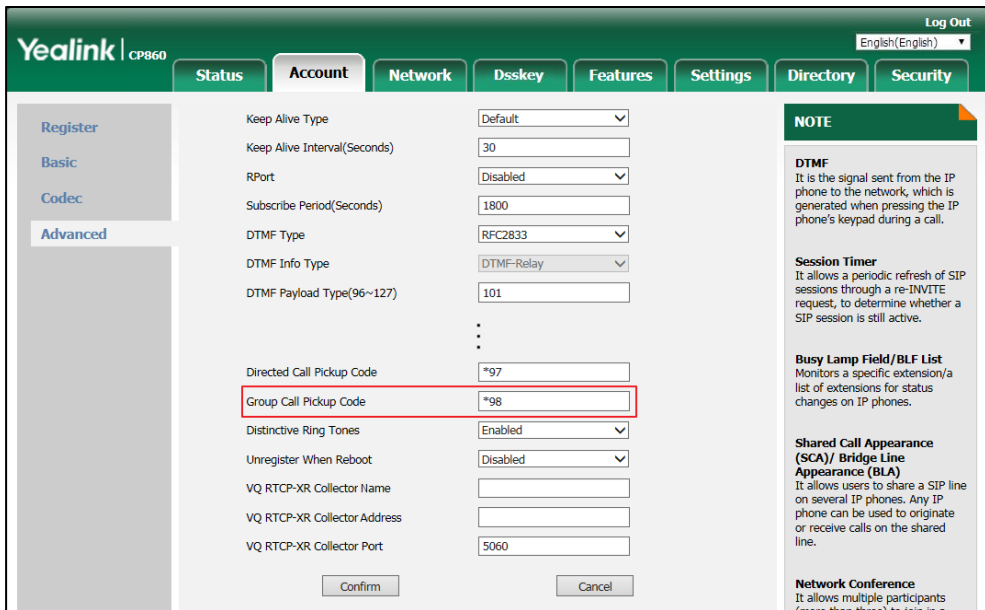

- Click **Confirm** to accept the change.

**To pick up a call in the group:**

- Press  .

The **GPickup** soft key appears on the LCD screen.



- Press the **GPickup** soft key on your phone when a phone in the group receives an incoming call.

The call is answered on your phone.

**Note**

The directed call pickup code and group call pickup code are predefined on the system server. Contact your system administrator for more information.

The call pickup code configured on a per-line basis takes precedence over that configured on a global basis.

## Anonymous Call

You can use anonymous call to block your identify and phone number from appearing to the called party when you call someone. For example, you want to call to consult some services, but don't want to be harassed. You can also configure the phone to send anonymous on/off code to the server to activate/deactivate anonymous call on the server side.

**Note**

Anonymous call is not available on all servers. Contact your system administrator for the anonymous call on code and off code.

### To configure anonymous call via phone user interface:

1. Press **Menu->Features->Anonymous Call**.
2. Press  to select **Local Anonymous** and then press the ◀ or ▶ soft key to select **Enabled** from the **Local Anonymous** field.

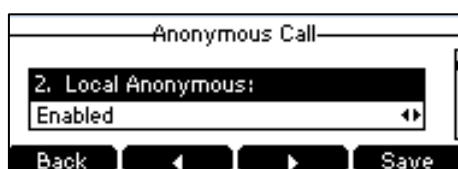

3. (Optional.) Press the ◀ or ▶ soft key to select the desired value from the **Send Anonymous Code** field.

The phone will send the configured on code or off code depending on your selection when you enable or disable anonymous call feature on the phone.

4. (Optional.) Enter the anonymous call on code in the **On Code** field.
5. (Optional.) Enter the anonymous call off code in the **Off Code** field.
6. Press the **Save** soft key to accept the change or the **Back** soft key to cancel.

Anonymous call is configurable via web user interface at the path **Account->Basic**.

### To place an anonymous call:

1. Use the specific phone to place a call to phone B.





The LCD screen of phone B prompts an incoming call from anonymity.





## Anonymous Call Rejection

You can use anonymous call rejection to reject incoming calls from anonymous callers. Anonymous call rejection automatically rejects incoming calls from callers who deliberately block their identities and numbers from being displayed.

**To configure anonymous call rejection via phone user interface:**

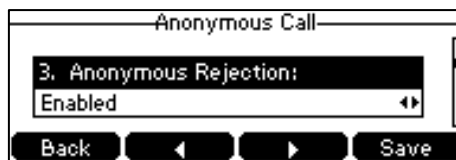
1. Press **Menu->Features->Anonymous Call**.
2. Press  or  to scroll to the **Anonymous Rejection** field.
3. Press the  or  soft key to select **Enabled** from the **Anonymous Rejection** field.



4. (Optional.) Press  or  to select the desired value from the **Send Rejection Code** field.

The phone will send the configured reject on code or reject off code depending on your selection when you enable or disable anonymous call rejection feature on the phone.

5. (Optional.) Enter the anonymous call rejection on code in the **On Code** field.
6. (Optional.) Enter the anonymous call rejection off code in the **Off Code** field.
7. Press the **Save** soft key to accept the change or the **Back** soft key to cancel.

Anonymous call rejection is configurable via web user interface at the path **Account->Basic**.

## Advanced Phone Features

This chapter provides operating instructions for the advanced features of the CP860 IP conference phone. Topics include:

- [Recording Using a USB Flash Drive](#)
- [Intercom](#)
- [Multicast Paging](#)
- [Music on Hold](#)
- [Shared Call Appearance \(SCA\)](#)

- [Bridged Line Appearance \(BLA\)](#)
- [Messages](#)
- [Using PC or Mobile Device with the Conference Phone](#)

If you require additional information or assistance with your new phone, contact your system administrator.

## Recording Using a USB Flash Drive

### Call and Conference Recording

You can insert a USB flash drive into the USB port on your phone to manually record active calls and conferences, or automatically record once the call is set up. Recordings are stored in \*.wav format. The filenames include a date & time stamp and the other party's number/IP address/name (or the first person's number/IP address/name you called), for example, 20161123-1630-1011 was created on November 23, 2016, at 16:30 and you have a call with 1011.

#### Note

Recording feature is not available by default. For more information, contact your system administrator.

The size of a single recording file should be less than 2G.

When your phone is idle, and you insert a USB flash drive into the USB port on your phone, the phone will detect the USB flash drive and display the prompt message "USB Inserted" and the icon .



If the phone detects the USB flash drive successfully, the icon  will display on the idle screen.

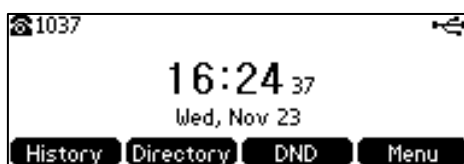

#### Note

Before recording any call, especially those involving PSTN, it is necessary to know about the rules and restrictions of any governing call-recording in the place where you are. It is also very important to have the consent of the person you are calling before recording the conversation.

**The Start REC soft key controls the recording function, and is available:**

- When there are one or more calls connected to your phone

- During an active call
- When calls are on hold or muted
- During an attended transfer
- During a conference call

**The Start REC soft key is not available when:**

- There are no connected calls on your phone
- You place a new call
- The phone prompts you to answer an incoming call

**The recording is not be paused when the following occurs:**

- You place a call on hold
- You mute a call
- You set up a conference call
- You perform the attended or semi-attended transfer
- An incoming calls arrives on your phone

## Call Recording

**To record a call:**

1. Press the **More** soft key and then press the **Start REC** soft key during a call.

If automatic recording feature is enabled, the call will be automatically recorded once it is set up.

The LCD screen prompts the approximate time remaining (depending on the free space of the USB flash drive), and displays the icon ● and recording duration.



If you press the **Hold** soft key while recording, only you are recorded. If you press  while recording, only the callee is recorded.

If there is insufficient free space (less than 1 hour) on the USB flash drive during recording, the LCD screen prompts the following:

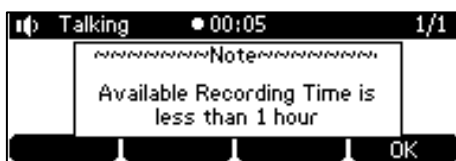

Press the **OK** soft key to return to the previous screen.



If there is insufficient free space (less than 2 minutes) on the USB flash drive when you press the **Start REC** soft key, or when the call is set up to automatically record, the recording is not started, and the LCD screen prompts the following:

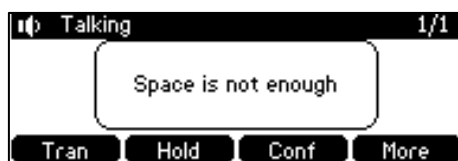

If there is insufficient free space (less than 2 minutes) on the USB flash drive during recording, recording is automatically stopped, the LCD screen prompts the following:



**Note** You can hold, transfer or set up a conference call while recording.

When you end a call while recording, the recording will be stopped and saved to USB flash drive automatically.

**To stop recording while the phone records, do one of the following:**

- Press the **More** soft key, and then press the **Stop REC** soft key.

The LCD screen prompts "Record file saved", and the recording icon and recording duration disappear.



- When there is only a call on the phone, press the **More** soft key and then press the **EndCall** soft key, or press  directly.

The LCD screen prompts "Record file saved", the recording icon and recording duration disappear, and the phone returns to the idle screen.



The recording will be stored as a new .wav file on the USB flash drive when the phone starts recording again.

## Conference Recording

You can record conference calls in the same way as other calls with the following exceptions:

All conference participants are recorded while recording. If one of the participants presses the **Hold** soft key, only that participant is recorded. If one of the participants presses  , only that participant is not recorded.

## Idle Recording

You can insert a USB flash drive into the USB port on your phone to record an important discussion when the phone is idle. Recordings are stored in \*.wav format. The filenames include a date & time stamp and a keyword "idleREC", for example, 20161202-1043-idleREC was created on December 2, 2016, at 10:43 when the phone is idle.

### Note

Idle recording is not available by default. For more information, contact your system administrator.

The size of a single recording file should be less than 2G.

### To record a discussion when the phone is idle:

1. Press **Menu**->**USB Record**->**Idle Record**.
2. Press the **Start REC** soft key.

The LCD screen displays the icon  and recording duration.



### During the recording, you can do the following:

- To pause the recording, press the **Pause REC** soft key. The **Resume REC** soft key appears on the LCD screen. The LCD screen displays the icon  and the duration stops counting. To continue the recording, press the **Resume REC** soft key.
- To stop the recording, press the **Stop REC** soft key. The LCD screen prompts "Record file saved".
- To go back to the previous screen, press the **Back** soft key. The phone returns to the USB Record screen. The recording continues.
- To record the remote party and local party, press the **Conf** soft key to place a new call.

## Recorded Files Playback

If you insert a USB flash drive into the USB port on your phone, you can play back recorded files

on your phone.

You can also browse and delete the recorded files on the USB flash drive.

### Note

Playback can occur on either the phone itself or a computer using an application capable of playing .wav files.

### To browse the recorded files:

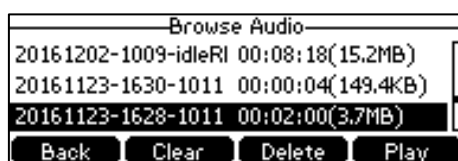

1. Press **Menu->USB Record->Browse Audio**.

The LCD screen shows all recorded files on the USB flash drive. The recording duration and the size of the recorded file display after the filename.





2. Press  or  to scroll through the recorded files.

### To play back a recording:

1. Press **Menu->USB Record->Browse Audio**.
2. Press  or  to highlight the recording you want to play back.
3. Press the **Play** soft key.





### During the recording playback, you can do the following:

- To pause the playback, press the **Pause** soft key. The **Play** soft key appears on the LCD screen.  
To continue the playback, press the **Play** soft key.
- To skip forward the playback, press the  soft key. Press once to skip forward 8 seconds.
- To rewind the playback, press the  soft key. Press once to rewind 8 seconds.
- To adjust the volume of the speakerphone, press  .
- To stop the playback, press the **Back** soft key. The phone returns to the Browse Audio screen.

If you are playing back a recorded call and an incoming call arrives on your phone, the playback pauses and the phone rings. The playback will not continue until you press the **Play** soft key.

**To delete a recorded file:**

1. Press **Menu->USB Record->Browse Audio**.
2. Press  or  to highlight the recording you want to delete.
3. Press the **Delete** soft key.

The LCD screen prompts the following warning:



4. Press the **OK** soft key to confirm the deletion or the **Cancel** soft key to cancel.
- You can also delete all recorded files by pressing the **Clear** soft key.

## Intercom

Intercom is a useful feature in an office environment to quickly connect with the operator or the secretary. You can press the intercom key to automatically connect with a remote extension for outgoing intercom calls, and the remote extension will automatically answer incoming intercom calls.

**Note** Intercom is not available on all servers. Contact your system administrator for more information.

## Outgoing Intercom Calls

**To configure an intercom key via web user interface:**

1. Click on **Dsskey->Programmable Key**.
2. Select the desired programmable key.
3. Select **Intercom** from the pull-down list of **Type**.
4. Enter the remote extension number in the **Value** field.

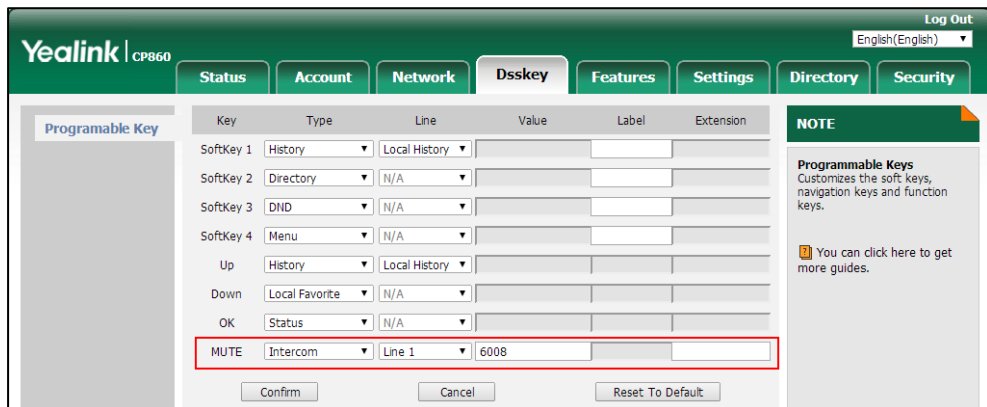

5. Click **Confirm** to accept the change.

## Incoming Intercom Calls

The CP860 IP conference phone supports automatically to answer an incoming intercom call by default. The phone automatically plays a warning tone when it receives an incoming intercom call. In addition, you can enable the phone to mute the microphone when it automatically answers an incoming intercom call. You can also enable the phone to automatically answer an incoming intercom call while there is already an active call on the phone. The active call is then placed on hold.

Intercom features you need to know:

Intercom Feature	Description
Intercom Allow	Enable or disable the IP phone to answer an incoming intercom call.
Intercom Mute	Enable or disable the IP phone's microphone for intercom calls.
Intercom Tone	Enable or disable the IP phone to play a warning tone when it receives an incoming intercom call.
Intercom Barge	Enable or disable the IP phone to automatically answer an incoming intercom call while there is already an active call on the phone.

### Intercom Allow

You can enable or disable the phone to answer an incoming intercom call. If Intercom Allow is enabled, the phone will automatically answer an incoming intercom call. If Intercom Allow is disabled, the phone will handle an incoming intercom call like a normal call instead of directly rejecting it. Intercom Allow is enabled by default.

#### Note

Your administrator can set a period of delay time before the phone automatically answers intercom calls. Contact your system administrator for more information.

### Intercom Mute

You can mute or un-mute the phone's microphone for intercom calls automatically. If Intercom Mute is enabled, the microphone will be muted for intercom calls. If Intercom Mute is disabled, the microphone will work for intercom calls. Intercom Mute is disabled by default.

### Intercom Tone

You can enable or disable the phone to play a warning tone when receiving an intercom call. If Intercom Tone is enabled, the phone will play a warning tone before answering the intercom call. If Intercom Tone is disabled, the phone will automatically answer the intercom call without warning. Intercom Tone is enabled by default.

### Intercom Barge

You can enable or disable the phone to automatically answer an incoming intercom call while there is already an active call on the phone. If Intercom Barge is enabled, the phone will automatically answer the intercom call and place the active call on hold. If Intercom Barge is disabled, the phone will handle an incoming intercom call like a waiting call. Intercom Barge is disabled by default.

#### Note

To enable the phone to receive a new incoming call when it has an active call, make sure that call waiting feature is enabled on the phone in advance. For more information, refer to [Call Waiting](#) on page 87.

#### To configure intercom features via phone user interface:

1. Press **Menu**->**Features**->**Intercom**.
2. Make the desired changes.

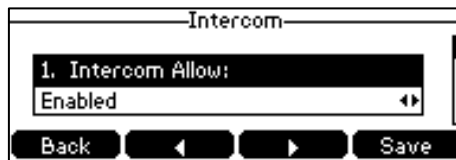

3. Press the **Save** soft key to accept the change or the **Back** soft key to cancel.

These specific parameters are configurable via web user interface at the path **Features**->**Intercom**.

## Using Intercom

#### To place an intercom call when the target phone is idle:

1. Press the intercom key when the phone is idle.

The called destination plays a warning tone and automatically answers the call in the hands-free (speakerphone) mode by default.

2. Press  or the **EndCall** soft key, to end the intercom call.

## Multicast Paging

You can use multicast paging to quickly and easily broadcast time sensitive announcements to people who are listening to a specific multicast group and a specific channel. You can configure a paging key or paging list key on the phone, which allows you to send a Real Time Transport Protocol (RTP) stream to the pre-configured multicast address(es) and channel(s) without involving SIP signaling. You can configure the phone to receive an RTP stream from pre-configured multicast listening address(es) and channel(s) without involving SIP signaling. You can specify up to 31 multicast listening addresses and channels.

Yealink IP phone supports the following 31 channels:

- **0:** You can broadcast audio to channel 0. Note that the Yealink IP phones running old firmware version (old paging mechanism) can be regarded as listening to channel 0. It is the default channel.
- **1 to 25:** You can broadcast audio to a specific channel. We recommend that you specify these channels when broadcasting with Polycom IP phones which have 25 channels you can listen to.
- **26 to 30:** You can broadcast audio to a specific channel. We recommend that you specify these channels when broadcasting with Yealink IP phones running new firmware version (new paging mechanism).

The IP phones will automatically ignore all incoming multicast paging calls on the different channel.

## Sending RTP Stream

**To configure a multicast paging key via web user interface:**

1. Click on **Dsskey**->**Programable Key**.
2. Select the desired programable key.
3. Select **Paging** from the pull-down list of **Type**.
4. Enter the multicast IP address and port number (e.g., 224.5.6.20:10008) in the **Value** field.  
The valid multicast IP addresses range from 224.0.0.0 to 239.255.255.255.
5. Enter the desired channel in the **Extension** field.

The valid channel ranges from 0 to 30.

The screenshot shows the 'Programable Key' configuration page in the Yealink CP860 web interface. The 'Dsskey' tab is active, and the 'Programable Key' sub-tab is selected. A table lists various keys with their configurations. The 'MUTE' key is highlighted with a red box, showing its configuration: Type: Paging, Line: N/A, Value: 224.5.6.20:10008, Label: (empty), Extension: 0. A 'NOTE' box on the right explains that this page is for customizing soft keys, navigation keys, and function keys. At the bottom, there are 'Confirm', 'Cancel', and 'Reset To Default' buttons.

Key	Type	Line	Value	Label	Extension
SoftKey 1	History	Local History			
SoftKey 2	Directory	N/A			
SoftKey 3	DND	N/A			
SoftKey 4	Menu	N/A			
Up	History	Local History			
Down	Directory	N/A			
OK	Status	N/A			
MUTE	Paging	N/A	224.5.6.20:10008		0

6. Click **Confirm** to accept the change.

**To configure a paging list key via web user interface:**

1. Click on **Dsskey**->**Programable Key**.
2. Select the desired programable key.

3. Select **Paging List** from the pull-down list of **Type**.

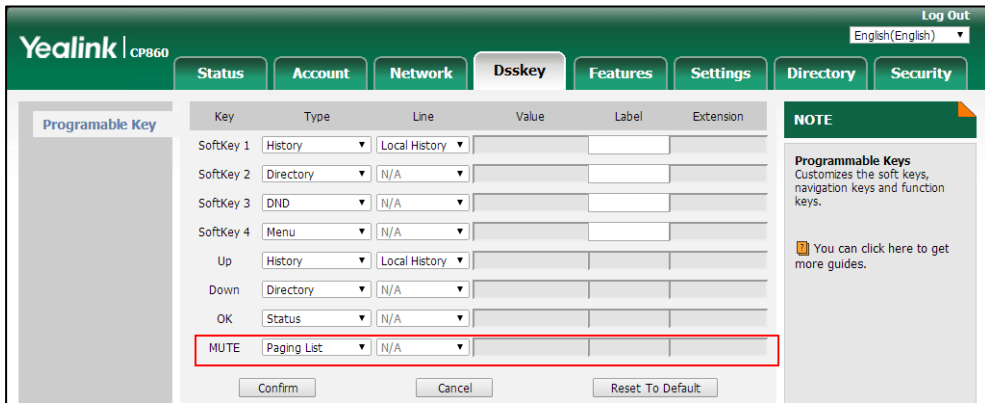

4. Click **Confirm** to accept the change.

**To configure paging list via phone user interface:**

1. Press the paging list key when the phone is idle.

If the paging list key is not configured, you can also press **Menu->Features->Paging List** to configure the paging list.

2. Press or to select a desired paging group.

The default tag is Empty if it is not configured before.

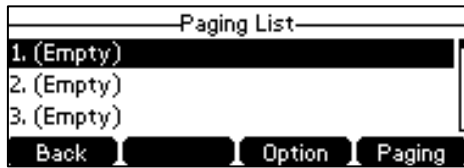

3. Press the **Option** soft key, and then press the **Edit** soft key.

4. Enter the multicast IP address and port number (e.g., 224.5.6.20:10008) in the **Address** field.

The valid multicast IP addresses range from 224.0.0.0 to 239.255.255.255.

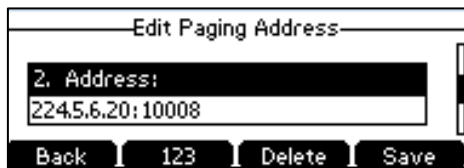

5. Enter the group name in the **Label** field.

6. Enter the desired channel in the **Channel** field.

The valid channel ranges from 0 to 30.





7. Press the **Save** soft key to accept the change.



- Repeat steps 2 to 7, you can add more paging groups.

Paging list is configurable via web user interface at the path: **Directory->Multicast IP**.

#### To delete a paging group via phone user interface:

- Press the paging list key when the phone is idle.
- Press  or  to select a desired group.
- Press the **Option** soft key, and then select **Delete** soft key.

The LCD screen prompts "Delete selected paging group?".

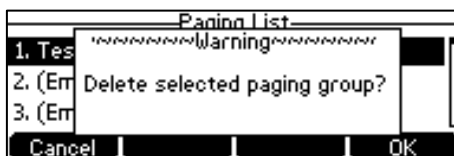

- Press the **OK** soft key to accept the change or the **Cancel** soft key to cancel.

If you want to delete all paging groups, you can press the **Del All** soft key.

You can also configure the phone to use a default codec for sending multicast RTP stream via web user interface.

#### To configure a default codec for multicast paging via web user interface:

- Click on **Features->General Information**.
- Select the desired codec from the pull-down list of **Multicast Codec**.

The default codec is G722.

- Click **Confirm** to accept the change.

#### Note

If G722 codec is used for multicast paging, the LCD screen will display the **HD** icon to indicate that it is providing high definition voice.

Default codec for multicast paging is configurable via web user interface only.

## Receiving RTP Stream

You can configure the phone to receive a Real Time Transport Protocol (RTP) stream from the pre-configured multicast address(es) and channel(s) without involving SIP signaling. You can specify up to 31 multicast addresses and channels that the phone listens to on the network.

How the phone handles incoming multicast paging calls depends on Paging Barge and Paging Priority Active parameters configured via web user interface.

### Paging Barge

The paging barge parameter defines the priority of the voice call in progress. If the priority of an incoming multicast paging call is lower than that of the active call, it will be ignored automatically. If Disabled is selected from the pull-down list of Paging Barge, the voice call in progress will take precedence over all incoming multicast paging calls. Valid values in the Paging Barge field:

- **1 to 31:** Define the priority of the active call, 1 with the highest priority, 31 with the lowest.
- **Disabled:** The voice call in progress will take precedence over all incoming paging calls.

### Paging Priority Active

The paging priority active parameter decides how the phone handles incoming multicast paging calls when there is already a multicast paging call on the phone. If enabled, the phone will ignore incoming multicast paging calls with lower priorities, otherwise, the phone will answer incoming multicast paging calls automatically and place the previous multicast paging call on hold. If disabled, the phone will automatically ignore all incoming multicast paging calls.

### To configure multicast listening addresses via web user interface:

1. Click on **Directory->Multicast IP**.
2. Select the desired value from the pull-down list of **Paging Barge**.
3. Select the desired value from the pull-down list of **Paging Priority Active**.
4. Enter the multicast IP address(es) and port number (e.g., 224.5.6.20:10008) which the phone listens to for incoming RTP multicast in the **Listening Address** field.
5. (Optional.) Enter the label in the **Label** field.  
Label will appear on the LCD screen when receiving the multicast RTP stream.
6. Select the desired channel to listen from the pull-down list of **Channel**.

The default channel is 0.

The screenshot shows the Yealink CP860 web interface. The 'Multicast Listening' section is active. Two dropdown menus are highlighted with a red box: 'Paging Barge' is set to '31' and 'Paging Priority Active' is set to 'Enabled'. Below this is a table with 10 rows. The first row is highlighted with a red box and contains the following data:

IP Address	Listening Address	Label	Channel	Priority
1 IP Address	224.5.6.20:10008	Product	0	1
2 IP Address			0	2
3 IP Address			0	3
4 IP Address			0	4
5 IP Address			0	5
6 IP Address			0	6
7 IP Address			0	7
8 IP Address			0	8
9 IP Address			0	9
10 IP Address			0	10

On the right side, there is a 'NOTE' section titled 'Multicast Paging' which explains that this feature allows IP phones to send/receive RTP streams to/from pre-configured multicast addresses without SIP signaling. It also notes that up to 10 listening multicast addresses can be specified on the IP phone and provides a link to more guides.

- Click **Confirm** to accept the change.

**Note** The priorities of listening addresses are predefined: 1 with the highest priority, 31 with the lowest. Both the multicast paging sender and receiver's phones play a warning tone when establishing a multicast paging call. Multicast listening addresses are configurable via web user interface only.

## Using Multicast Paging

**To send RTP stream via a multicast paging key when the receiver's phone is idle:**

- Press the multicast paging key when the phone is idle.

The phone sends RTP to a preconfigured multicast address (IP: Port).

Both the sender's and receiver's phones play a warning tone and the receiver automatically answers the multicast RTP session in the hands-free (speakerphone) mode.

LED indicators illuminate solid green.

The following figure shows a multicast RTP session on the phone:



- You can do the following:

- To place the current multicast RTP session on hold, press the **Hold** soft key.



The sender's phone places the multicast RTP session on hold and receiver's phone releases the session.

To resume the held multicast RTP session, press the **Resume** soft key.

The multicast RTP session is established again.

- To end the multicast RTP session, press the **EndCall** soft key.

**To send RTP stream via a paging list key when the receiver's phone is idle:**

1. Press the paging list key when the phone is idle.
2. Press  or  to select the desired paging group.
3. Press the **Paging** soft key to send RTP.
4. You can do the following:
  - To place the current multicast RTP session on hold, press the **Hold** soft key.  
The sender's phone places the multicast RTP session on hold and receiver's phone releases the session.  
To resume the held multicast RTP session, press the **Resume** soft key.  
The multicast RTP session is established again.
  - To end the multicast RTP session, press the **EndCall** soft key.

**Note** Multicast RTP is one way only from the sender to the multicast address(es) (receiver). For outgoing RTP multicasts, all other existing calls on the phone will be placed on hold.

## Music on Hold

Music on hold (MoH) is the business practice of playing recorded music to fill the silence that would be heard by the party placed on hold. To use this feature, you should specify a SIP URI pointing to a Music on Hold Server account. When a call is placed on hold, the phone will send a SIP INVITE message to the Music on Hold Server account. The Music on Hold Server account automatically answers the SIP INVITE messages and immediately plays audio from some source located anywhere (LAN, Internet) to the held party. Contact your system administrator for the SIP URI.

**To configure music on hold server via web user interface:**

1. Click on **Account->Advanced**.

- Enter the SIP URI (e.g., sip:moh@sip.com) in the **Music Server URI** field.

The screenshot shows the Yealink CP860 web interface. The 'Account' tab is selected. The 'Music Server URI' field is highlighted with a red box and contains the value 'sip:moh@sip.com'. Other fields include 'Keep Alive Type' (Default), 'Keep Alive Interval(Seconds)' (30), 'RPort' (Disabled), 'Subscribe Period(Seconds)' (1800), 'DTMF Type' (RFC2833), 'DTMF Info Type' (DTMF-Relay), 'SIP Server Type' (Default), 'Directed Call Pickup Code', 'Group Call Pickup Code', 'Distinctive Ring Tones' (Enabled), 'Unregister When Reboot' (Disabled), 'VQ RTPC-XR Collector Name', 'VQ RTPC-XR Collector Address', and 'VQ RTPC-XR Collector Port' (5060). A 'NOTE' section on the right provides information about DTMF, Session Timer, Busy Lamp Field/BLF List, Shared Call Appearance (SCA)/ Bridge Line Appearance (BLA), and Network Conference.

- Click **Confirm** to accept the change.

When you have placed a call on hold, the held party can hear the music.

#### Note

For this feature to function, all involved parties cannot use encrypted RTP (SRTP).

Music on hold server is configurable via web user interface only.

## Shared Call Appearance (SCA)

You can use SCA feature to share an extension which can be registered on two or more IP phones at the same time. The shared line is indicated by a different line icon.

In the following figure, the registered line is shared:



If two phones share a line, an incoming call to this extension will cause both phones to ring simultaneously. The incoming call can be answered on either phone but not both.

This feature is very useful in the boss and secretary scenario. For example, the secretary can share the boss's extension on her phone. When there is an incoming call to the extension of the boss, both the phones of the boss and the secretary will ring simultaneously. Either the boss or the secretary can answer the call.

## Configuring SCA Feature on the IP Phone

You can configure a primary account on the IP phone and other alternate accounts on the other IP phones. For example, party A, party B share the account 4603, phone A registers the primary account 4603, phone B registers the alternate account 4603\_1, phone C registers the account 4604.

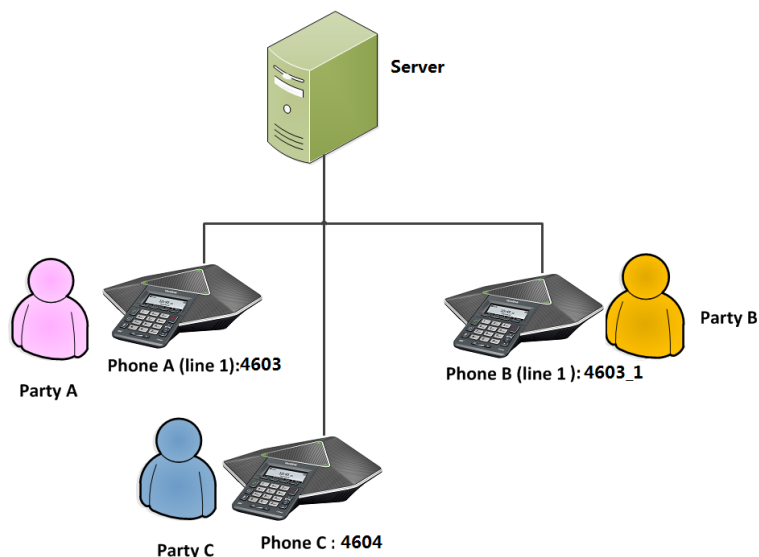

To configure the shared line settings on phone A via web user interface:

1. Register the account 4603.

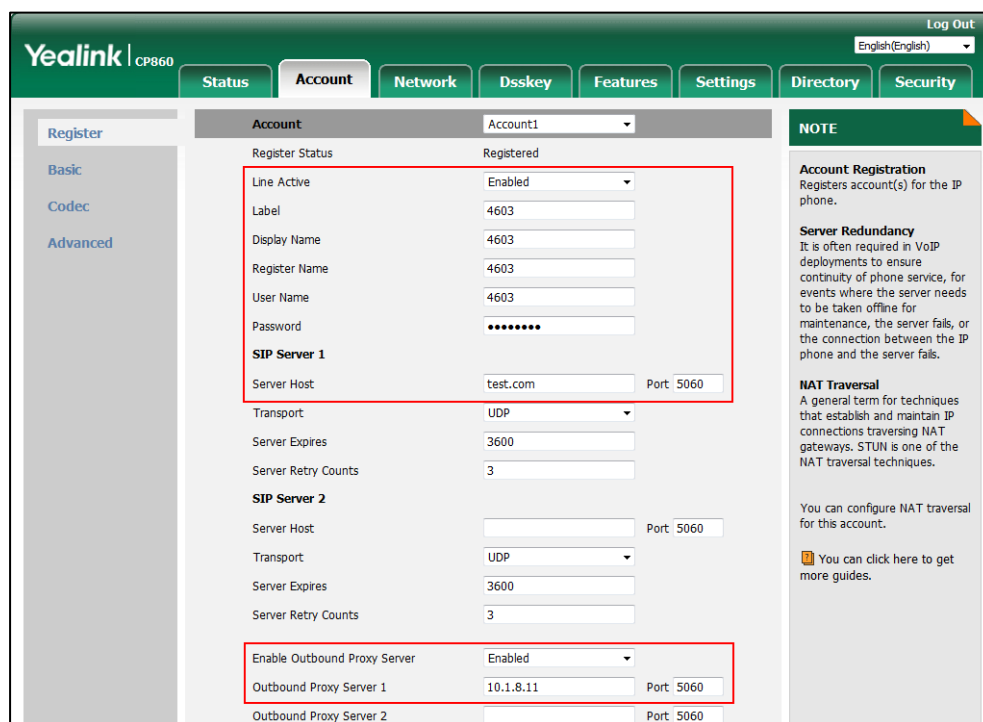

- Click on **Advanced**, and then select **Shared Call Appearance** from the pull-down list of **Shared Line**.

The screenshot shows the Yealink CP860 web interface. The 'Account' tab is selected, and the 'Advanced' settings are visible. The 'Shared Line' dropdown menu is highlighted with a red box and set to 'Shared Call Appearance'. Other settings include 'Keep Alive Type' (Default), 'Keep Alive Interval' (30), 'RPort' (Disabled), 'Subscribe Period' (1800), 'DTMF Type' (RFC2833), 'DTMF Info Type' (DTMF-Relay), 'PTime' (20), 'BLA Number', 'BLA Subscription Period' (300), 'Unregister When Reboot' (Disabled), 'VQ RTPC-XR Collector Name', 'VQ RTPC-XR Collector Address', and 'VQ RTPC-XR Collector Port' (5060). A 'NOTE' section on the right provides information about DTMF, Session Timer, Busy Lamp Field/BLF List, Shared Call Appearance (SCA)/ Bridge Line Appearance (BLA), and Network Conference.

- Click **Confirm** to accept the change.

**To configure the shared line settings on phone B via web user interface:**

- Register the alternate account 4603\_1.  
(Enter the primary account 4603 in the **Register Name** field.)

The screenshot shows the Yealink CP860 web interface. The 'Account' tab is selected, and the 'Account1' settings are visible. The 'Line Active' dropdown is highlighted with a red box and set to 'Enabled'. The 'Enable Outbound Proxy Server' dropdown is also highlighted with a red box and set to 'Enabled'. Other settings include 'Register Status' (Registered), 'Label' (4603\_1), 'Display Name' (4603\_1), 'Register Name' (4603), 'User Name' (4603\_1), 'Password' (masked), 'SIP Server 1' (Server Host: test.com, Port: 5060, Transport: UDP, Server Expires: 3600, Server Retry Counts: 3), 'SIP Server 2' (Server Host, Port: 5060, Transport: UDP, Server Expires: 3600, Server Retry Counts: 3), 'Outbound Proxy Server 1' (10.1.8.11, Port: 5060), and 'Outbound Proxy Server 2' (Port: 5060). A 'NOTE' section on the right provides information about Account Registration, Server Redundancy, and NAT Traversal.

- Click on **Advanced**, and then select **Shared Call Appearance** from the pull-down list of **Shared Line**.

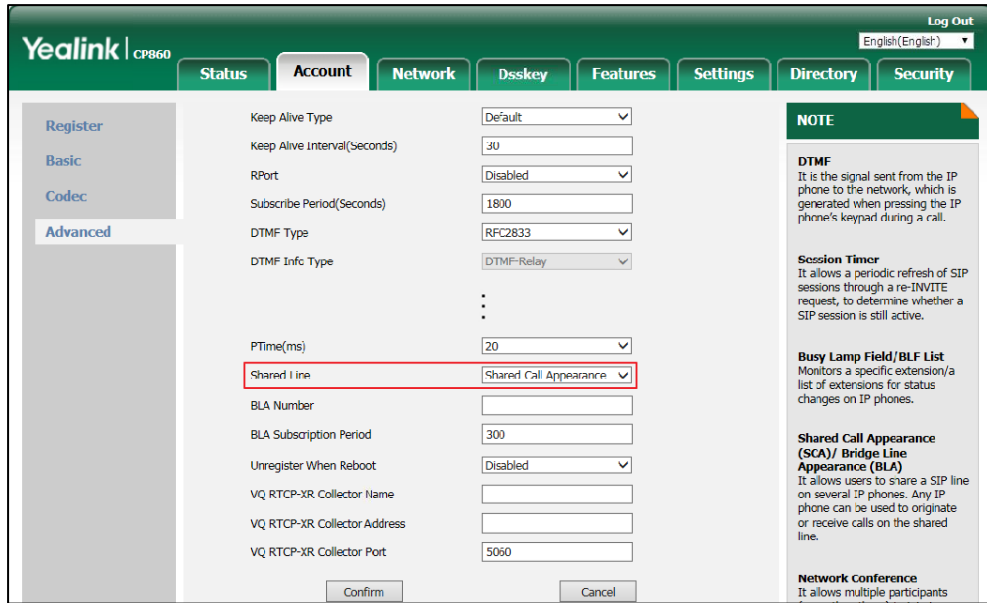

- Click **Confirm** to accept the change.

## Using SCA Feature on the IP Phone

This section provides you with detailed information on using the CP860 IP Conference phone in a SCA scenario.



You can do the following using CP860 IP Conference phone in a SCA scenario:

- Placing calls
- Answering calls
- Place a call on hold
- Retrieving a held call

## Placing Calls

You can have one call or multiple calls on the shared line.

### To place a call on the shared line:



- Enter the desired number using the keypad when the phone is idle.
- Press , ,  or the **Send** soft key.

### To place multiple calls on the shared line:

You can have more than one call on the shared line. To place a new call when there is an active call on phone A, do one of the following on phone A:

- Press the **Hold** soft key. The original call is placed on hold.



2. Press the **NewCall** soft key to enter the dialing screen.
3. Enter the desired number using the keypad.
4. Press , ,  or the **Send** soft key.  
Phone A will dial the entered number.





## Answering Calls

You can have one call or multiple calls on the shared line. Incoming calls will be distributed evenly among the available shared line.

### To answer a call on the shared line:

When an incoming call arrives on the shared line, the phone A and phone B will ring simultaneously. You can answer the incoming call on either phone A or phone B but not both.

Do one of the following on phone A or phone B:

- Press ,  or the **Answer** soft key on phone A.  
Phone B stops ringing.
- Press ,  or the **Answer** soft key on phone B.  
Phone A stops ringing.



### To answer multiple calls on the shared line:

An incoming call arrives on the shared line when there is an active call on phone A. You can answer the incoming call on either phone A or phone B. The LCD screen of phone A displays the information of the incoming call (e.g., "Incoming call: 4604 Yealink").



**Note** Make sure call waiting feature is enabled on phone A. For more information, refer to [Call Waiting](#) on page 87.

Do one of the following on phone A:

- Press the **Answer** soft key. Phone B stops ringing.
- Press  to access the new call.  
Press ,  or the **Answer** soft key. Phone B stops ringing.  
The incoming call is answered and the original call is placed on hold.

You can also answer the call on phone B:

1. Press ,  or the **Answer** soft key. Phone A stops ringing.

## Placing a Call on Hold

### To place a call on hold:

1. Press the **Hold** soft key on phone A when party A and party C are talking.  
The shared line call is placed on hold.

## Retrieving a Held Call

If there is a held call between phone A and phone C, you can retrieve a held call on phone A.

### To retrieve the held call on phone A:

1. Press the **Resume** soft key on phone A.  
The conversation between phone A and phone C is retrieved.

## Bridged Line Appearance (BLA)

BLA allows users to share a SIP line on two or more IP phones. Users can monitor the specific extension (BLA number) for status changes on each IP phone. To use this feature, a BLA group should be pre-configured on the server and one of them is specified as a BLA number. BLA depends on support from a SIP server.

In the following figure, the registered account is shared:



Any IP phone can be used to originate or receive calls on the bridged line. An incoming call to the BLA number can be presented to multiple phones in the group simultaneously. The incoming call can be answered on any IP phone of the group but not all.

## Configuring BLA Feature on the IP Phone

You can share a BLA number on two or more phones. For example, phone A registers the account 14019833020 and assigns BLA number, phone B registers the account 10462190020 and assigns BLA number, phone C registers the account 14755608020. Phone A and phone B share the BLA number 14084588327.

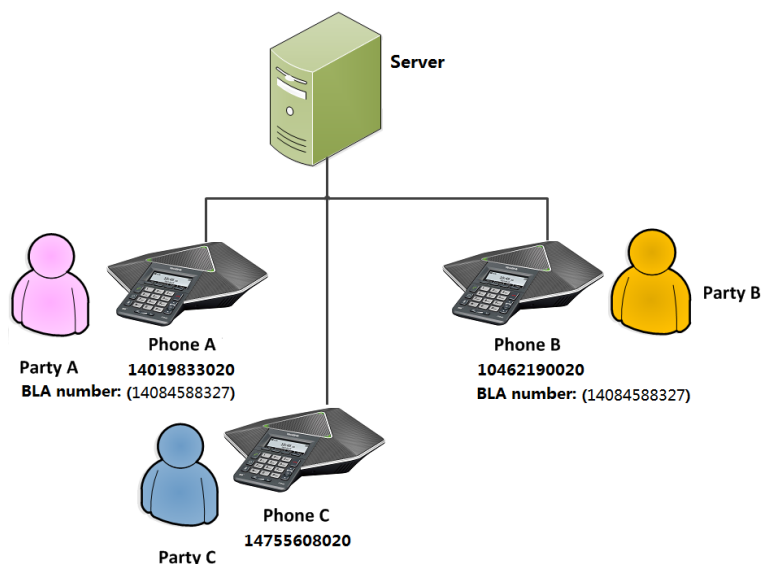

To register account and configure BLA feature on phone A via web user interface:

1. Register the account 14019833020.

The screenshot shows the Yealink CP860 web user interface. The 'Account' tab is selected, and the 'Advanced' section is active. The 'SIP Server 1' section is highlighted with a red box, showing the following configuration:

Line Active	Enabled
Label	14019833020
Display Name	14019833020
Register Name	14019833020
User Name	14084588327
Password	*****
<b>SIP Server 1</b>	
Server Host	sip.test.com Port: 5060
Transport	UDP
Server Expires	3600
Server Retry Counts	3
<b>SIP Server 2</b>	
Server Host	Port: 5060
Transport	UDP
Server Expires	3600
Server Retry Counts	3
<b>Enable Outbound Proxy Server</b>	Enabled
Outbound Proxy Server 1	sip114.test.com Port: 5060
Outbound Proxy Server 2	Port: 5060

The 'NOTE' section on the right contains the following information:

- Account Registration:** Registers account(s) for the IP phone.
- Server Redundancy:** It is often required in VoIP deployments to ensure continuity of phone service, for events where the server needs to be taken offline for maintenance, the server fails, or the connection between the IP phone and the server fails.
- NAT Traversal:** A general term for techniques that establish and maintain IP connections traversing NAT gateways. STUN is one of the NAT traversal techniques.

You can configure NAT traversal for this account. You can click here to get more guides.

2. Click on **Advanced**, and then select **Draft BLA** from the pull-down list of **Shared Line**.

3. Enter the desired number in the **BLA Number** field.

The screenshot shows the 'Account' configuration page for a Yealink CP860 phone. The 'Advanced' tab is active. The 'BLA Number' field is highlighted with a red box and contains the value '14084588327'. Other visible fields include 'Keep Alive Type' (Default), 'Keep Alive Interval(Seconds)' (30), 'RPort' (Disabled), 'Subscribe Period(Seconds)' (1800), 'DTMF Type' (RFC2833), 'DTMF Info Type' (DTMF-Relay), 'PTime(ms)' (20), 'Shared Line' (Draft BLA), 'BLA Subscription Period' (300), 'Unregister When Reboot' (Disabled), and 'VQ RTPC-XR Collector' fields (Name, Address, Port: 5060). A 'NOTE' section on the right provides information about DTMF, Session Timer, Busy Lamp Field/BLF List, Shared Call Appearance (SCA)/ Bridge Line Appearance (BLA), and Network Conference.

4. Click **Confirm** to accept the change.

**To register account and configure BLA feature on phone B via web user interface:**

1. Register the account 10462190020.

The screenshot shows the 'Account' configuration page for a Yealink CP860 phone. The 'Advanced' tab is active. The 'SIP Server 1' and 'SIP Server 2' sections are highlighted with red boxes. The 'SIP Server 1' section shows 'Server Host' as 'sip.test.com' and 'Port' as '5060'. The 'SIP Server 2' section shows 'Server Host' as 'sip114.test.com' and 'Port' as '5060'. The 'Enable Outbound Proxy Server' field is also highlighted with a red box and set to 'Enabled'. Other visible fields include 'Register Status' (Registered), 'Line Active' (Enabled), 'Label' (10462190020), 'Display Name' (10462190020), 'Register Name' (10462190020), 'User Name' (14084588327), 'Password' (masked), 'Transport' (UDP), 'Server Expires' (3600), and 'Server Retry Counts' (3). A 'NOTE' section on the right provides information about Account Registration, Server Redundancy, and NAT Traversal.

2. Click on **Advanced**, and then select **Draft BLA** from the pull-down list of **Shared Line**.

- Enter the desired number in the **BLA Number** field.

The screenshot shows the Yealink CP860 web interface with the 'Account' tab selected. The 'Advanced' section is expanded, showing various settings. The 'BLA Number' field is highlighted with a red box and contains the value '14084588327'. Other settings include 'Keep Alive Type' (Default), 'Keep Alive Interval(Seconds)' (30), 'RPort' (Disabled), 'Subscribe Period(Seconds)' (1800), 'DTMF Type' (RFC2833), 'DTMF Info Type' (DTMF-Relay), 'PTime(ms)' (20), 'Shared Line' (Draft BLA), 'BLA Subscription Period' (300), 'Unregister When Reboot' (Disabled), and 'VQ RTPC-XR Collector Port' (5060). A 'NOTE' section on the right provides information about DTMF, Session Timer, Busy Lamp Field/BLF List, Shared Call Appearance (SCA)/ Bridge Line Appearance (BLA), and Network Conference.

- Click **Confirm** to accept the change.

## Using BLA Feature on the IP Phone

This section provides you with detailed information on using the CP860 IP phone in a BLA scenario.



You can do the following using CP860 IP phone in a BLA scenario:

- Placing calls
- Answering calls
- Place a call on hold
- Retrieving a held call

## Placing Calls

You can have one call or multiple calls on the shared line.



### To place a call on the shared line:

- Enter the desired number using the keypad when the phone is idle.
- Press , ,  or the **Send** soft key.

### To place multiple calls on the shared line:

You can have more than one call on the shared line. To place a new call when there is an active call on phone A, do one of the following on phone A:





- Press the **Hold** soft key. The original call is placed on hold.

2. Press the **NewCall** soft key to enter the dialing screen.
3. Enter the desired number using the keypad.
4. Press  ,  ,  or the **Send** soft key.  
Phone A will dial the entered number.

## Answering Calls

When the phone C dials the BLA number "14084588327", an incoming call will arrive on the bridged line. The phone A and phone B ring simultaneously. You can answer the incoming call on either phone A or phone B but not both.

Do one of the following on phone A or phone B:

- Press  ,  or the **Answer** soft key on phone A.  
Phone B stops ringing.
- Press  ,  or the **Answer** soft key on phone B.  
Phone A stops ringing.

## Placing a Call on Hold

**To place a call on hold:**

1. Press the **Hold** soft key on phone A when party A and party C are talking.  
The bridged line call is placed on hold.

## Retrieving a Held Call

If there is a held call between phone A and phone C, you can retrieve a held call on phone A.

**To retrieve the held call on phone A:**

1. Press the **Resume** soft key on phone A.  
The conversation between phone A and phone C is retrieved.

## Messages

### Short Message Service (SMS)

You can send and receive text messages using the CP860 IP phone. New text messages can be indicated both acoustically and visually. When receiving a new text message, the phone will play a warning tone. The LCD screen will prompt “n New Text Message(s)” (“n” indicates the number of unread text messages, e.g., 1 New Text Message(s)) and display an icon .



#### Note

When the phone receives a text message, the text message prompt window will pop up by default, if you want to disable the feature, contact your system administrator for more information.

You can store text messages in your phone’s Inbox, Sentbox, Outbox or Draftbox. Each of the boxes can store up to 100 text messages. If the number of the text messages in one box is more than 100, the phone will directly delete the oldest text message in the box.

#### Note

SMS is not available on all servers. Contact your system administrator for more information.

#### To read a text message:

1. Press **Menu->Message->Text Message->Inbox**.



2. Select the desired message and then press the **View** soft key.

#### Note

If the phone prompts receiving new text messages, you can also press the **View** soft key to read the new messages directly.

#### To send a text message:

1. Press **Menu->Message->Text Message->New Message**.

- Compose the new text message. You can press the **abc** soft key to change the input mode.



- Press the **Send** soft key after completing the content.
- Enter the number you want to send the message to in the **To** field.
- Press the **Send** soft key to send the message or the **Back** soft key to cancel.

Sending a text message is configurable via web user interface at the path **Features->SMS**.

**To reply a text message:**

- Press **Menu->Message->Text Message->Inbox**.
- Select the desired message and then press the **Reply** soft key.
- Compose the new text message. You can press the **abc** soft key to change the input mode.

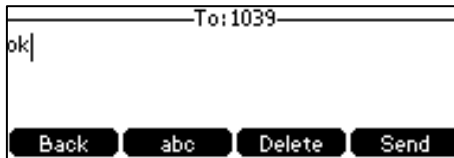

- Press the **Send** soft key after completing the content.
- Check the **From** and **To** fields, and then press the **Send** soft key.

**To delete a text message:**

- Press **Menu->Message->Text Message->Inbox (Sentbox, Outbox or Draftbox)**.
- Select the desired message and then press the **Delete** soft key.

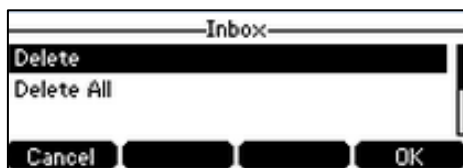

- Select **Delete** to delete the desired message, and then press the **OK** soft key.

The LCD screen prompts "Delete the selected message?".

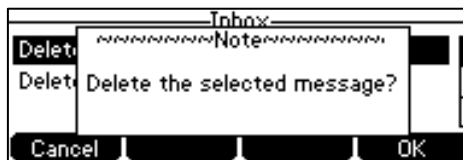

- Press the **OK** soft key to delete this message or the **Cancel** soft key to cancel.



You can also delete all text messages by pressing the **Delete** soft key and then select **Delete All**. For more information, refer to the above steps.

**Note** You can also delete a specific message after retrieving by pressing the **Delete** soft key.

## Voice Mail

You can leave voice mails for someone else using the CP860 IP conference phone. You can also listen to voice mails that are stored in voice mailbox. When receiving a new voice mail, the phone will play a warning tone. The LCD screen will prompt “n New Voice Mail(s)” (“n” indicates the number of unread voice messages, e.g., 89 New Voice Mail(s)) and display an icon .



If the voice mail pop-up message box disappears, it won't pop up again unless the user receives a new voice mail or the user re-registers the account that has unread voice mail(s).

**Note** Voice Mail is not available on all servers. You can configure the phone not to display the pop-up prompt, contact your system administrator for more information.

### To leave a voice mail:

You can leave a voice mail for someone else when he/she is busy or inconvenient to answer the call. Follow the voice prompt from the system server to leave a voice mail, and then hang up.

### To configure voice mail access codes via phone user interface:

1. Press **Menu->Message->Voice Mail->Set Voice Mail Code**.
2. Press the **123** soft key to select the proper input mode and then enter the voice mail access code (e.g., \*88).



3. Press the **Save** soft key to accept the change or the **Back** soft key to cancel.

**Note** Voice mail access codes must be predefined on the system server. Contact your system administrator for the more information.

**To listen to voice mails:**

1. When the LCD screen prompts that the phone receives a new voice mail, you can press the **Connect** soft key to dial out the voice mail access code.
2. Follow the voice prompt to listen to your voice mails.

**Note**

Before listening to voice mails, make sure the voice mail access code has been configured.

**To view the voice mail via phone user interface:**

1. Press **Menu->Message->Voice Mail->View Voice Mail**.

The LCD screen displays the amount of new and old voice mails.

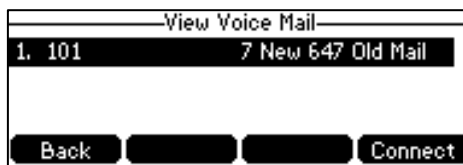

2. Press the **Connect** soft key to listen to voice mails.

## Message Waiting Indicator (MWI)

The CP860 IP conference phone supports MWI feature when receiving a new voice message. If someone leaves you a voice mail, you will receive a message waiting indicator. MWI will be indicated via an indicator message (including a voice mail icon) on the LCD screen. This will be cleared when you retrieve all voice mails or delete them.

The MWI service is unsolicited for some servers, so the CP860 IP conference phone only handles the MWI messages sent from the server. But for other servers, the MWI service is solicited, so the CP860 IP conference phone must enable subscription for MWI.

**Note**

MWI service is not available on all servers. Contact your system administrator for more information.

The MWI subscription parameters you need to know:

Options	Description
<b>Subscribe for MWI</b>	Enable or disable a subscription for MWI service.
<b>MWI Subscription Period</b>	Period of MWI subscription. The IP phone sends a refresh SUBSCRIBE request before initial SUBSCRIBE expiration.
<b>Subscribe MWI To Voice Mail</b>	Enable or disable a subscription to the voice mail number for MWI service. To use this feature, you should also configure the voice mail number.

#### Note

The phone will send SUBSCRIBE messages for the MWI service to the account or the voice number MWI service depending on the server. Contact your system administrator for more information.

#### To configure subscribe for MWI via web user interface:

1. Click on **Account**->**Advanced**.
2. Select **Enabled** from the pull-down list of **Subscribe for MWI**.
3. Enter the period time in the **MWI Subscription Period(Seconds)** field.

The screenshot shows the Yealink CP860 web interface. The 'Account' tab is active, and the 'Advanced' sub-tab is selected. The 'Subscribe for MWI' dropdown is set to 'Enabled', and the 'MWI Subscription Period(Seconds)' text input field contains '3600'. A red rectangular box highlights these two settings. Other settings visible include 'Keep Alive Type' (Default), 'Keep Alive Interval(Seconds)' (30), 'RPort' (Disabled), 'Subscribe Period(Seconds)' (1800), 'DTMF Type' (RFC2833), 'DTMF Info Type' (DTMF-Relay), 'DTMF Payload Type(96~127)' (101), 'Retransmission' (Disabled), 'Subscribe Register' (Disabled), and 'Subscribe MWI To Voice Mail' (Disabled). A 'NOTE' section on the right provides information about DTMF, Session Timer, Busy Lamp Field/BLF List, and Shared Call Appearance (SCA)/ Bridge Line Appearance (BLA).

4. Click **Confirm** to accept the change.

The IP phone will subscribe to the account number for MWI service by default.

#### To enable Subscribe MWI to Voice Mail via web user interface:

1. Click on **Account**->**Advanced**.
2. Select **Enabled** from the pull-down list of **Subscribe for MWI**.
3. Select **Enabled** from the pull-down list of **Subscribe MWI To Voice Mail**.

4. Enter the desired voice mail number in the **Voice Mail** field.

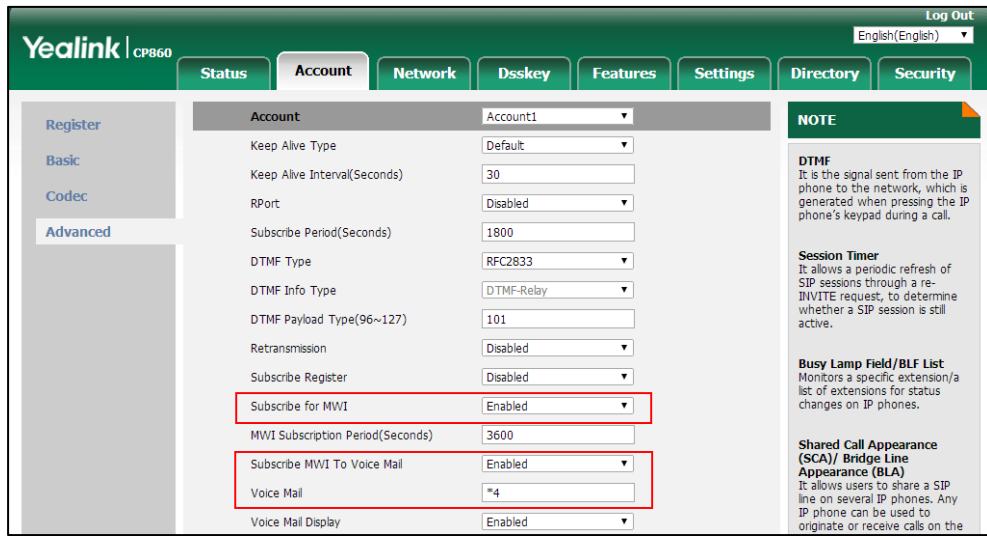

5. Click **Confirm** to accept the change.

The IP phone will subscribe to the voice mail number for MWI service using Subscribe MWI To Voice Mail.

**Note** MWI subscription is configurable via web user interface only.

## Using PC or Mobile Device with the Conference Phone

You connect a PC or mobile device to your IP conference phone so you can use the conference phone's speaker to stream two-way audio from the PC or mobile device for hands-free conversations. For more information on how to connect the PC or mobile device, refer to [Connecting the Optional PC or Mobile Device](#) on page 16.

From your conference phone, you can do the following:

- Place a PC or mobile audio on hold.
- Set up a conference between the calls on your conference phone and the PC or mobile device.
- Answer calls from other phones while you connect the PC or mobile device to the conference phone.

## Connecting the PC or Mobile Device to the Conference Phone

You can connect the PC or mobile audio when your conference phone is idle, when you have a call or conference call, or when you are placing a call.

### To connect the PC or mobile audio when your conference phone is idle:

1. Connect the PC or mobile device to the conference phone.

The PC or mobile audio plays through your conference phone's speaker. For example, if the PC

or mobile device plays a video or music, you can listen to the audio on your conference phone. If an incoming call arrives on the PC or mobile device and the PC or mobile device answers it, you can listen and speak to the caller on your conference phone.



**To connect the PC or mobile audio when there is a call or conference call on your conference phone:**

1. Connect the PC or mobile device to the conference phone.

The original call or conference call is placed on hold. The PC or mobile audio plays through your conference phone's speaker.



**To connect the PC or mobile audio when you are placing a call:**

1. Connect the PC or mobile device to the conference phone.

The dialing is canceled. The PC or mobile audio plays through your conference phone's speaker.



## Placing the PC or Mobile Audio on Hold

You can place an active PC or mobile audio on hold. When you place the PC or mobile audio on hold, you cannot hear any audio associated with the PC or mobile device on your conference phone.

**To place the PC or mobile audio on hold:**

1. Press the **Hold** soft key.

LED indicators flash green. The LCD screen indicates that the audio is on hold.



**To resume the PC or mobile audio:**

1. Press the **Resume** soft key.

## Muting or Un-muting the PC or Mobile Audio

You can mute the PC or mobile audio so that the other party cannot hear you, but you can still hear the other party.

### To mute the PC or mobile audio:

1. Press .

LED indicators illuminate solid red. The LCD screen indicates that the audio is muted



### To un-mute the PC or mobile audio:

1. Press  again.

## Creating Conference Calls with the PC or Mobile Audio

### To create a conference call with the PC or mobile audio, do one of the following:

- If you have an active PC or mobile audio, press the **Conf** soft key, and then place a new call to the other party. Press the **Conf** soft key again when the party answers the call.
- If you have an active PC or mobile audio and a call or conference call on hold, press the **Conf** soft key.

#### Note

The conference phone can set up five-way conference call with the PC or mobile audio. For more information on how to set up a conference call, refer to [Local Conference](#) on page 87.

## Adjusting the Volume of the PC or Mobile Audio

You can adjust the volume of the PC or mobile audio on your conference phone or on the PC or mobile device.

### To adjust the volume of the PC or mobile audio:

1. When you connect the PC or mobile audio, press  to adjust the volume of the conference phone's speaker.

## Removing the PC or Mobile Audio

To remove the PC or mobile audio, disconnect the 3.5mm jack cable from the conference phone.

## Using Your Phone with PSTN Account

You can connect optional expansion PSTN box CPN10 to extend functions of the conference phone. Calls can be made using the Public Switched Telephone Network (PSTN). Up to 2 cascaded PSTN Boxes can be installed to an IP conference phone, which allows you to experience the local three-way conference conveniently in excellent speech quality with PSTN. For more information on how to connect the PSTN box, refer to [Connecting the Optional Expansion PSTN Box CPN10](#) on page 15.

When using PSTN, some features are not available, such as transfer, DND, forward and so on. For more information, refer to [Appendix C - Unavailable Features for PSTN](#) on page 158.

## Configuring the PSTN Account



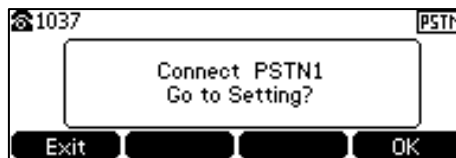

When the first PSTN box CPN10 is connected to the phone successfully, the LCD screen prompts "Connect PSTN1 Go to Setting?". When the second PSTN box CPN10 is connected to the first PSTN box CPN10 successfully, the LCD screen prompts "Connect PSTN2 Go to Setting?".

When two PSTN boxes are connected simultaneously to the phone successfully, the LCD screen prompts "Connect PSTN1 PSTN2 Go to Setting?".



You can press the **OK** soft key to configure the PSTN account or press the **Exit** soft key to cancel. If you press the **Exit** soft key, you can also configure the PSTN account at the path **Menu->Settings->Advanced Settings** (default password: admin) ->**Accounts**.

**To configure the PSTN account via phone user interface after pressing the OK soft key:**

1. (Optional.) Press  or  to select the desired PSTN account.
2. Press the **Enter** soft key.
3. Press the  or  soft key to select **Enabled** or **Disabled** from the **Active Line** field.

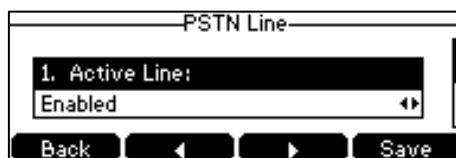



4. (Optional.) Enter the string that will appear on the LCD screen in the **Label** field.
5. Press the **Save** soft key to accept the change.

PSTN account is configurable via web user interface at the path **Account->Register**.

## Default Account

To configure the default account via phone user interface:

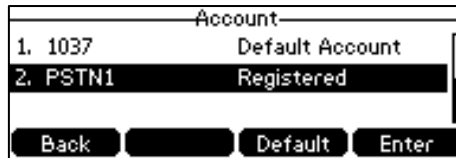

1. Press **Menu->Settings->Advanced Settings** (default password: admin) -> **Accounts**.
2. Press  or  to select the desired account.



3. Press the **Default** soft key.

## Selecting the Country for PSTN Use

To select the country which your phone operates in via phone user interface:

1. Press **Menu->Settings->Basic Settings->Country**.
2. Press  or  to select the desired country.



3. Press the **Save** soft key to accept the change.

## Flash Time

You can configure the flash time to adjust the length of time before a hook flash times out (or the call disconnects).



Flash time can be configured from the following options:

- **Auto:** It depends on the country that is configured for the phone (refer to [Selecting the Country for PSTN Use](#)). The flash time is automatically set for that country.
- **75msec, 100msec, 300msec or 600msec:** The hook flash times out after the designated time (in milliseconds).

To configure flash time via phone user interface:

1. Press **Menu->Settings->Advanced Settings** (default password: admin) -> **Flash Time**.



2. Press  or  to select the desired value.

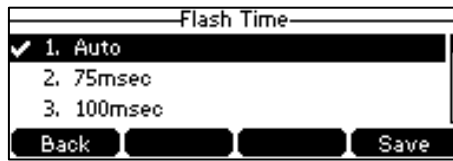

3. Press the **Save** soft key to accept the change.

**Note**

The required flash time may be different in different countries or for different gateways/PBX servers. For more information, contact your system administrator.

## Basic Call Features

### Placing Calls

You can press the off-hook key either before or after entering the number to place a call. You can also dial an entry from call history, local directory, favorite directory or remote phone book. For more information, refer to [Contact Management](#) on page 35 and [Call History Management](#) on page 49.

The call duration and far-site's information (name or phone number) are visible on the LCD screen. In the figure below, the call to 2248 has lasted 53 seconds.



**To place a call:**

Do one of the following:

- Press  to obtain a dial tone (You can press the **Switch** soft key to select the desired PSTN account).



Enter the desired number using the keypad.

Press , ,  or the **Send** soft key.

- Enter the desired number using the keypad.

Press , ,  or the **Send** soft key.







The # key is configured as a send key by default. You can also set the \* key as the send key, or



set neither. For more information, refer to the [Key As Send](#) on page 30.

The CP860 IP conference phone can handle multiple calls at a time. However, only one active call (the call that has audio associated with it) can be in progress at any given time. And one PSTN account can only support one call.

#### To place multiple calls:

You can have more than one call on your CP860 IP conference phone. To place a new call during an active call, do one of the following:

- Press . The active call is placed on hold.  
Enter the desired number using the keypad.  
Press , ,  or the **Send** soft key.
- Press the **Hold** soft key to place the original call on hold.  
Press the **NewCall** soft key.  
Enter the desired number using the keypad.  
Press , ,  or the **Send** soft key.

You can press  or  to switch between calls, and then press the **Resume** soft key to retrieve the desired call.



## Answering Calls

You can answer a call no matter whether you are in another call or not. But one PSTN account can only support one call.

#### Answering When Not in Another Call



Call duration and destination will always appear on the LCD screen for the active call.

#### To answer a call:

Press ,  or the **Answer** soft key.

#### Answering When in Another Call

If you have an active call, and an incoming call arrives on the phone, do one of the following:

- Press the **Answer** soft key.  
The incoming call is answered and the original call is placed on hold.
- Press  to access the new call.  
Press ,  or the **Answer** soft key.  
The incoming call is answered and the original call is placed on hold.

## Ending Calls

### To end a call:

Do one of the following:

- Press the **EndCall** soft key.
- Press .

### Note

To end a call placed on hold, you can press the **EndCall** soft key to end the call directly, or press the **Resume** soft key to resume the call before ending it.

## Redialing Numbers

For more information, refer to [Redialing Numbers](#) on page 74.

## Recent Call In Dialing

For more information, refer to [Recent Call In Dialing](#) on page 74.

## Auto Answer

You can enable auto answer to automatically answer an incoming call. You can also enable auto answer mute to mute the local microphone when an incoming call is answered automatically.

### To configure auto answer and auto answer mute via phone user interface:

1. Press **Menu->Features->Auto Answer**.
2. Press the ◀ or ▶ soft key to select the desired PSTN account from the **Line ID** field.
3. Press the ◀ or ▶ soft key to select **Enabled** from the **Status** field.
4. Press the ◀ or ▶ soft key to select **Enabled** from the **Auto Answer Mute** field.

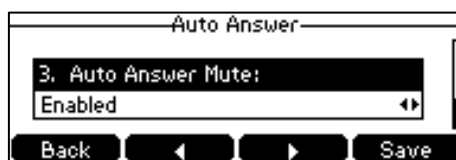

5. Press the **Save** soft key to accept the change or the **Back** soft key to cancel.

The icon  appears on the LCD screen.

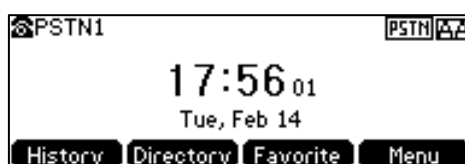

Auto answer is configurable via web user interface at the path **Account->Basic**.

**Note**

Auto answer is only applicable when there is no other call in progress on the phone.

## Auto Redial

For more information, refer to [Auto Redial](#) on page 76.

## ReCall

For more information, refer to [ReCall](#) on page 78.

## Call Mute

For more information, refer to [Call Mute](#) on page 78.

## Call Hold/Resume

You can place a call on hold/resume a held call for PSTN account in the same way as SIP/Cloud account with the following exceptions: when you place a call on hold, the other party cannot hear music on hold and the LCD screen of the other party doesn't indicate that the call is being held.

For more information, refer to [Call Hold/Resume](#) on page 80.

## Conference

As one PSTN account can only support one call. To set up a conference, you need to activate a hook flash. A hook flash is a quick off-hook/on-hook/off-hook cycle (just like picking up a handset, laying the handset down on the handset cradle, and then picking it up again). When you activate a hook flash, the message "Flashing" displays on the screen for about one second, as shown below:



Then the active call will be placed on hold, you are allowed to place a new call and connect three parties in a conference. You cannot view the last participant in the conference call.

You can also set up a conference with more than two parties when you have multiple accounts on the phone. You can view and manage each participant in the conference call.

**Note**



The way to set up a conference call using hook flash may be different for different gateways/PBX servers.

**To set up a conference call:**

1. Place a call to the first party.
2. When the first party answers the call, press the **Flash** soft key to activate a hook flash.  
The message "Flashing" displays on the screen for about one second and the active call is placed on hold.
3. Enter the number of the second party.
4. When the second party answers the call, press the **Flash** soft key again to join two parties in the conference.



To remove this party from the conference call, press the **Flash** soft key.





5. To add an additional party to the conference, press the **Conf** soft key (another account is needed).
6. Enter the number of the new party and then press , ,  or the **Send** soft key.
7. Press the **Conf** soft key when the party answers.
8. Repeat steps 5 to 7 to join more parties in the established conference call.



You can create a conference between an active call and a call on hold by pressing the the **Conf** soft key.

**To set up a conference call with an active call and a call on hold:**

1. Establish two calls on the phone.
2. Press  or  to select an active call.
3. Press the **Conf** soft key to join the two calls in the conference.

**During the conference call, you can do the following:**

- Press the **Hold** soft key to place the conference on hold.
- Press the **Conf** soft key to join more parties in an established conference call.
- Press the **Manage** soft key, and then press  or  to select the desired party:
  - Press the **FarMute** soft key to mute the party. The muted party can hear everyone, but no one can hear the muted party.

- Press the **Remove** soft key to remove the selected party from the conference call.
- Press the **All Split** soft key to split the conference call into individual calls on hold.
- Press the **Back** soft key to return to the previous screen.
- Press  to mute the conference call, all other participants can hear each other, but they cannot hear you.
- Press  or the **EndCall** soft key to drop the conference call.

## Advanced Phone Features

### Recording Using a USB Flash Drive

You can use the recording feature when connecting the PSTN box CPN10. But you need to connect the USB flash drive to the USB port on the PSTN box CPN10 in advance.

For more information on how to use recording feature, refer to [Call and Conference Recording](#) on page 99.

### Using PC or Mobile Device with the Conference Phone

For more information, refer to [Using PC or Mobile Device with the Conference Phone](#) on page 128.

# Troubleshooting

---

This chapter provides general troubleshooting information to help you solve the problems you might encounter when using your CP860 IP conference phone.

If you require additional information or assistance with your new phone, contact your system administrator.

## General Issues

### **How do I find the basic information of the IP phone?**

Press the OK key when the IP phone is idle to check the basic information of the IP phone, such as IP address and firmware version. For more basic information, refer to [Phone Status](#) on page 17.

### **How to obtain the MAC address of a phone when the phone is not powered on?**

Three ways to obtain the MAC address of a phone:

- You can ask your supplier for the shipping information sheet which includes MAC addresses according to the corresponding PO (Purchase Order).
- You can find the MAC address on the label of the carton box.
- You can also find the MAC address from the phone's bar code on the back of the phone.

### **What is the difference between user name, register name and display name?**

Both user name and register name are defined by the server. A user name is used to identify the account, while a register name matched with a password is used for authentication if the server requires. Display name is the caller ID that will be displayed on the callee's LCD screen. Server configuration may override the local configuration.

### **Why can't I send an SMS to any other phone?**

SMS depends on support from a SIP server. Contact your system administrator for more information.

## Display Issues

### **Why is the LCD screen blank?**

- Ensure that the phone is properly plugged into a functional AC outlet.
- Ensure that the phone is plugged into a socket controlled by a switch that is on.

- If the phone is plugged into a power strip, try to plug it directly into a wall outlet instead.
- If your CP860 IP conference phone is powered from PoE, ensure that you use a PoE-compliant switch or hub.

#### Why does the phone display "Network unavailable"?

- Ensure that the Ethernet cable is plugged into the Internet port on the phone and the Ethernet cable is not loose.
- Ensure that the switch or hub in your network is operational.

#### Why does the phone display "No Service"?

The LCD screen displays "No Service" when no SIP account registers successfully.

#### Why doesn't the phone display time and date correctly?

Check if you have configured the phone to obtain the time and date from the SNTP server automatically. If the phone fails to connect to the SNTP server, you need to configure the time and date manually.

## Password Issues

#### How to change the user password?

To change the user password via web user interface:

1. Click on **Security**->**Password**.
2. Select **user** from the pull-down list of **User Type**.
3. Enter the new user password in the **New Password** field and **Confirm Password** field.

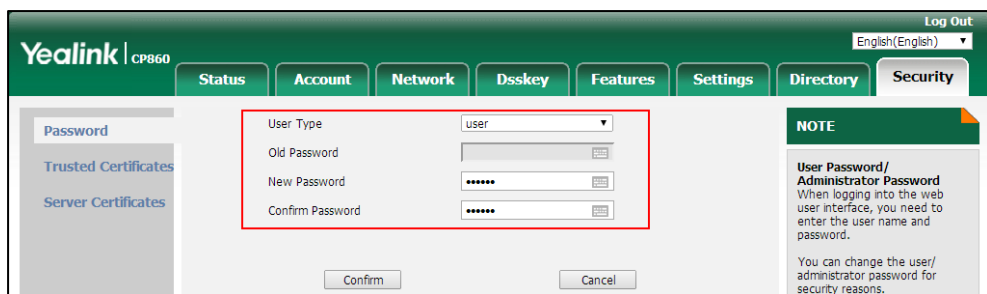

4. Click **Confirm** to accept the change.

You can also contact your system administrator for help.

#### Note

If logging into the web user interface of the phone with user credentials, you need to enter the current user password in the **Old Password** field.

User password is configurable via web user interface only.



## Call Issues

### Why can't I receive calls?

- Check the SIP registration with your system administrator.
- Check that DND (Do Not Disturb) mode is deactivated on your phone. Refer to [Do Not Disturb \(DND\)](#) on page 81.
- Check that call forward is disabled on the phone. Refer to [Call Forward](#) on page 82.
- Check whether the caller number is stored in the blacklist directory. Refer to [Blacklist](#) on page 45.

### Why can't I record calls?

- Ensure that the USB flash drive is inserted to the USB port on the phone.
- Ensure that the USB flash drive inserted is compatible with the phone. For more information, contact your reseller.
- Check if there is enough free space (greater than 2 minutes) on the USB flash drive. Press **Menu->USB Record->Storage Space**.

Storage Media Properties	
1. Total:	7.6GB
2. Used:	5.3MB (0.1% Used)
3. Free:	7.6GB (99.9% Free)
Back	

## Audio Issues

### Why doesn't the phone ring?

Check the ringer volume on the phone. To adjust the ringer volume setting, press the Volume key when the phone is on-hook and idle. For more information, refer to [Volume](#) on page 32.

### Why does the phone play a tone when hold? How to disable it?

When there is a call is on hold, the phone will play a hold tone every 30 seconds. Play hold tone is enabled by default. Play hold tone and the interval of playing a hold tone are configurable via web user interface only.

#### To configure the call hold tone and call hold tone delay via web user interface:

1. Click on **Features->General Information**.
2. Select the desired value from the pull-down list of **Play Hold Tone**.

3. Enter the desired time in the **Play Hold Tone Delay** field.

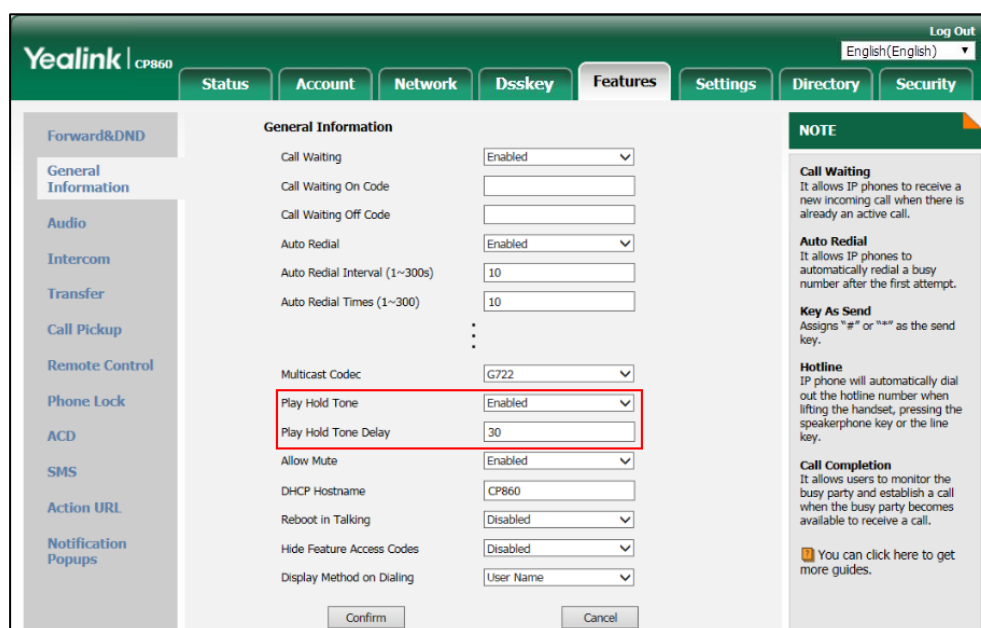

4. Click **Confirm** to accept the change.

#### How to make a call using SRTP?

You can enable SRTP to encrypt the audio stream(s) of phone calls. The parties participating in the call should enable SRTP.

#### To enable SRTP via web user interface:

1. Click on **Account->Advanced**.

2. Select the desired type from the pull-down list of **RTP Encryption(SRTP)**.

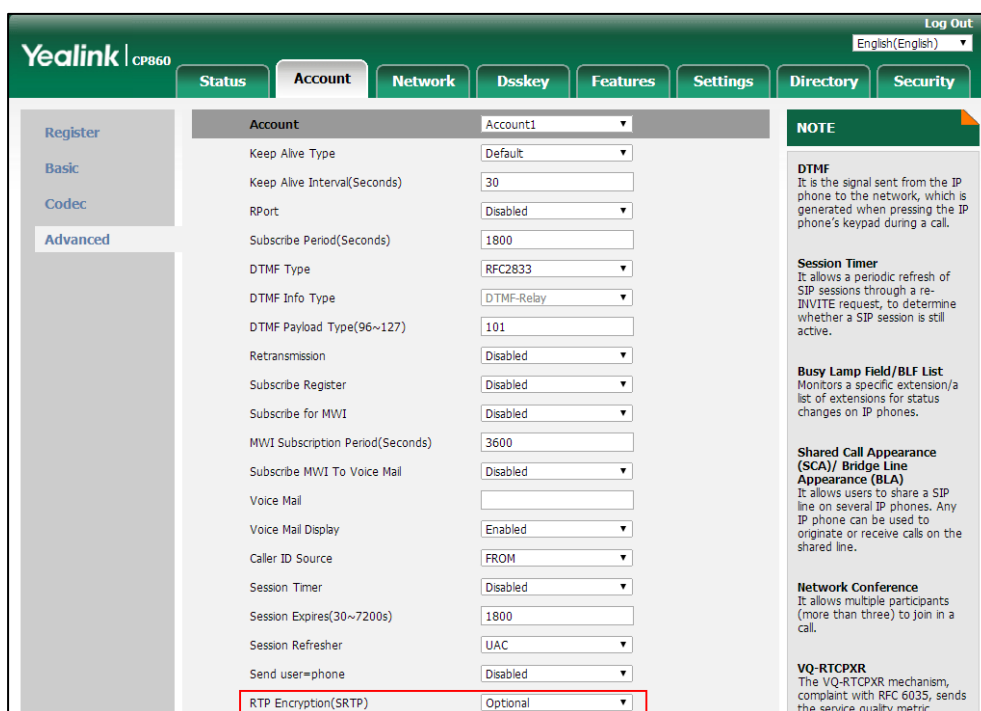

3. Click **Confirm** to accept the change.

**Note** SRTP is not available on all servers. Contact your system administrator for more information.  
SRTP is configurable via web user interface only.

## Network Issues

### How to diagnostic the network?

The wrong network settings may result in inaccessibility of your phone and may also have an impact on your network performance. In this case, you can use the “Ping” or “Traceroute” method to check whether the network is connected, analyze and judge network fault.

### To check the network using “Ping” method via phone user interface:

1. Press **Menu->Features->Diagnostics->Network->Ping**.
2. Enter the desired IP address or URL in the **Ping IP or URL** field.

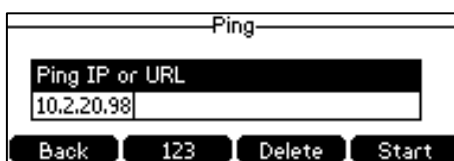

3. Press the **Start** soft key.

The screen displays the network status information.

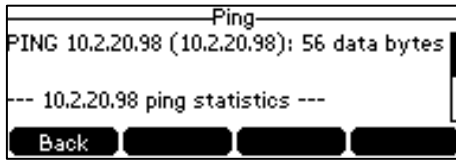

You can use the ping statistics information to check the network connection situation.

The following table shows the network connection situation and ping statistics:

Ping Statistics	Network Connection Situation
4 packets transmitted, 4 packets received, 0% packet loss	The network connection between you and the target is strong.
4 packets transmitted, 1, 2 or 3 packets received, 25%, 50% or 75% packet loss	The network connection between you and the target is unstable or faulty.
4 packets transmitted, 0 packets received, 100% packet loss	The network connection between you and the target is unreachable.

4. Press the **Back** soft key to back to the preview screen.

If you find that the network connection between you and the target is unreachable, you can traceroute the target to see where the problem is. It can also display the path traffic between your IP phone and the target.

**To check the network using “Traceroute” method via phone user interface:**

1. Press **Menu->Features->Diagnostics->Network->Trace Route**.
2. Enter the desired IP address or URL in the **Tracert IP or URL** field.

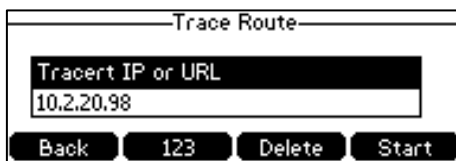

3. Press the **Start** soft key.

The screen displays the network status information.

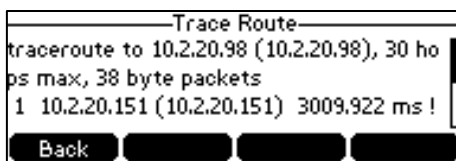

The first line of result is information about what you are doing. It shows the target, IP address of the target, the maximum number of hops that will be allowed, and the size of the packets being

sent.

Then the following line describes each network device in the path traffic between the IP phone and the target.

A traceroute can end with one of several error indications indicating why the traceroute cannot proceed. The following table shows the possible error messages:

Error Message	Meaning
* * *	Target unreachable.
!H	Host unreachable.
!N	Network unreachable.

Press the **Back** soft key to back to the preview screen.

## Log Issues

### How to export PCAP trace?

We may need you to provide a PCAP trace to help analyze your problem.

#### To export a PCAP trace via web user interface:

1. Click on **Settings->Configuration**.
2. Click **Start** to begin capturing signal traffic.
3. Recreate the error to be documented in the trace.
4. Click **Stop** to stop the capture.

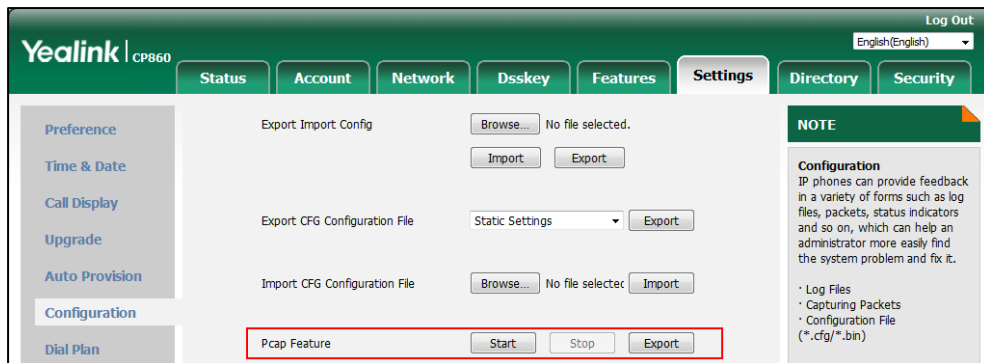

5. Click **Export** to open file download window, and then save the file to your local system.

### How to export local log?

We may need you to provide a system log or boot log to help analyze your problem.

#### To export the system log to a local PC via web user interface:

1. Click on **Settings->Configuration**.
2. Select **Enabled** from the pull-down list of **Enable Local Logging** field.
3. Select **6** from the pull-down list of **Local Log Level**.

The default local log level is "3".

4. Select **sys.log** from the pull-down list of **Export Local Log**.
5. Click **Confirm** to accept the change.

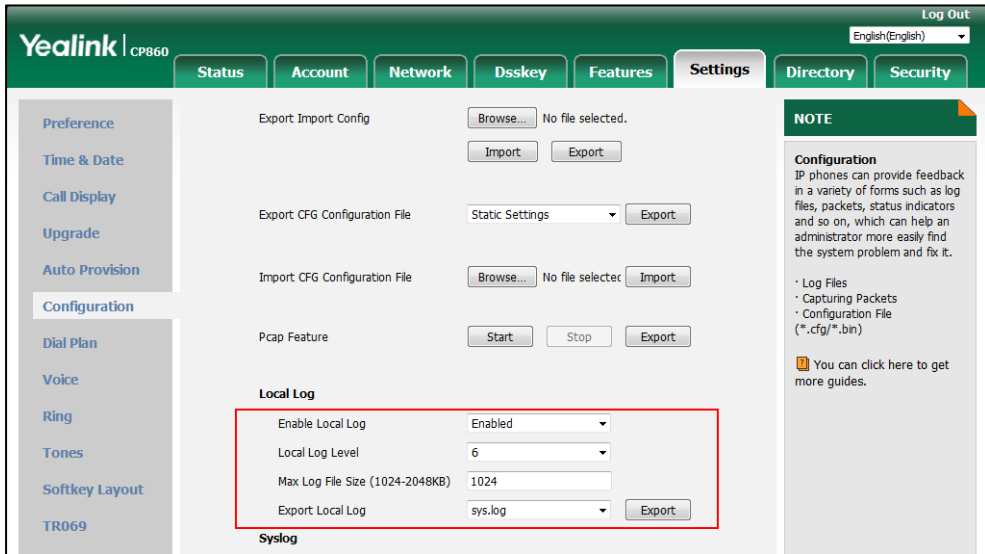

6. Reproduce the issue.
7. Click **Export** to open the file download window, and then save the file to your local system.

You can also export the system log to a syslog server. Contact your system administrator for more information.

**Note**

It is recommended to reset the local level to 3 after exporting the system syslog.

**To export the boot log to a local PC via web user interface:**

1. Click on **Settings->Configuration**.
2. Select **Enabled** from the pull-down list of **Enable Local Logging** field.
3. Select **boot.log** from the pull-down list of **Export Local Log**.
4. Click **Export** to open the file download window, and then save the file to your local system.

**How to export all diagnostic files?**

We may need you to provide three types of diagnostic files (including PCAP trace, system log and BIN configuration file) to help analyze your problem. You can export these files at a time.

**To export all diagnostic files via web user interface:**

1. Click on **Settings->Configuration**.

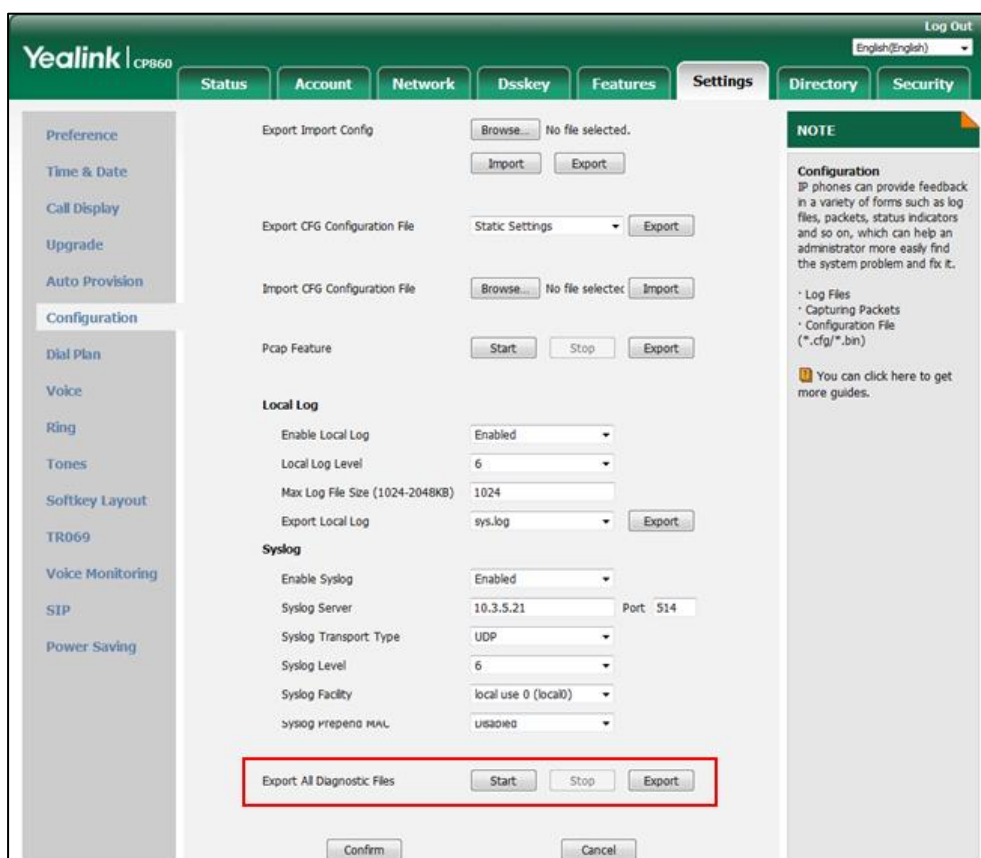

2. Click **Start** to begin capturing signal traffic.  
The local log level will be automatically set to 6.
3. Reproduce the issue.
4. Click **Stop** to stop the capture.  
The local log level will be reset to 3.
5. Click **Export** to open file download window, and then save diagnostic files to your local system.

**Note** If the issue cannot be reproduced, just directly click **Export** to export all diagnostic files.

## Reboot & Upgrade & Reset Issues

### How to reboot the phone?

**To reboot the phone via web user interface:**

1. Click on **Settings->Upgrade**.

2. Click **Reboot** to reboot the IP phone.

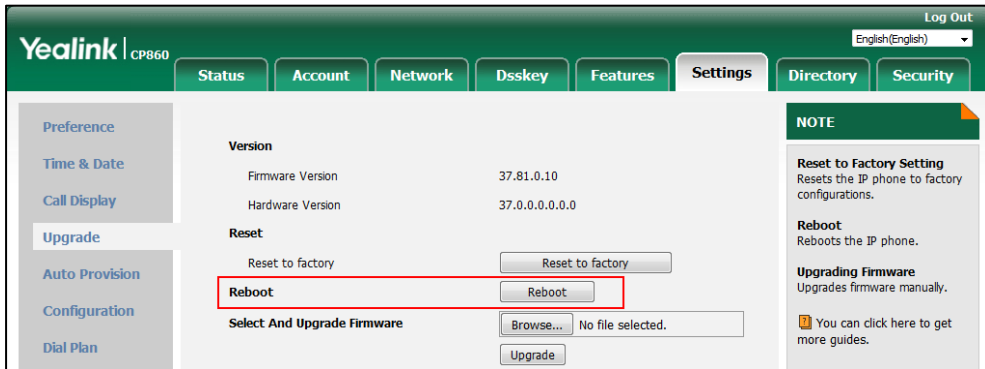

**Note** Any reboot of the phone may take a few minutes.

### How to upgrade firmware?

To upgrade firmware via web user interface:

1. Click on **Settings->Upgrade**.
2. Click **Browse** to locate the required firmware from your local system.

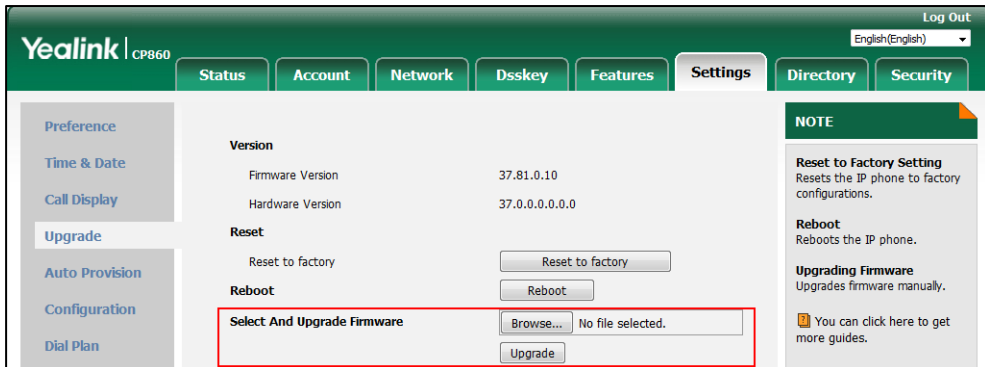

3. Click **Upgrade** to upgrade the firmware.  
The web user interface prompts "Firmware of the SIP Phone will be updated. It will take 5 minutes to complete. Please don't power off!".
4. Click **OK** to confirm upgrading.

### How to reset the phone?

Reset the phone to factory configurations after you have tried all troubleshooting suggestions but do not solve the problem. You need to note that all customized settings will be overwritten after a reset.

To reset the phone via phone user interface:

1. Press **Menu->Settings->Advanced Settings** (default password: admin) ->**Reset Config->Reset to Factory**.
2. Press the **Enter** soft key.



The LCD screen prompts the following warning:

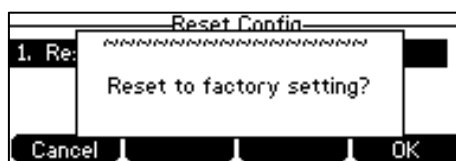

3. Press the **OK** soft key.

The LCD screen prompts the following:

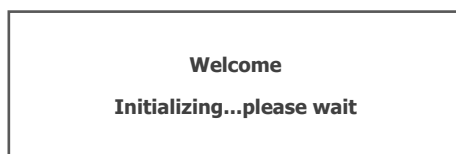

The phone will be reset to factory settings successfully after startup.

**Note**

Reset of your phone may take a few minutes. Do not power off until the phone has started up successfully.



## Regulatory Notices

---

### Service Agreements

Contact your Yealink Authorized Reseller for information on service agreements applicable to your product.

### Limitations of Liability

TO THE FULL EXTENT ALLOWED BY LAW, YEALINK EXCLUDES FOR ITSELF AND ITS SUPPLIERS ANY LIABILITY, WHETHER BASED IN CONTRACT OR TORT (INCLUDING NEGLIGENCE), FOR INCIDENTAL, CONSEQUENTIAL, INDIRECT, SPECIAL, OR PUNITIVE DAMAGES OF ANY KIND, OR FOR LOSS OF REVENUE OR PROFITS, LOSS OF BUSINESS, LOSS OF INFORMATION OR DATA, OR OTHER FINANCIAL LOSS ARISING OUT OF OR IN CONNECTION WITH THE SALE, INSTALLATION, MAINTENANCE, USE, PERFORMANCE, FAILURE, OR INTERRUPTION OF ITS PRODUCTS, EVEN IF YEALINK OR ITS AUTHORIZED RESELLER HAS BEEN ADVISED OF THE POSSIBILITY OF SUCH DAMAGES, AND LIMITS ITS LIABILITY TO REPAIR, REPLACEMENT, OR REFUND OF THE PURCHASE PRICE PAID, AT YEALINK'S OPTION. THIS DISCLAIMER OF LIABILITY FOR DAMAGES WILL NOT BE AFFECTED IF ANY REMEDY PROVIDED HEREIN SHALL FAIL OF ITS ESSENTIAL PURPOSE.

### Safety Instructions

**Save these instructions. Read these safety instructions before use!**

The following basic safety precautions should always be followed to reduce the risk of fire, electrical shock, and other personal injury.



#### General Requirements

- Before you install and use the device, read the safety instructions carefully and observe the situation during operation.
- During the process of storage, transportation, and operation, please always keep the device dry and clean.
- During the process of storage, transportation, and operation, please avoid collision and crash of the device.
- Please do not attempt to dismantle the device by yourself. In case of any discrepancy, please contact the appointed maintenance center for repair.
- Without prior written consent, no organization or individual is permitted to make any change to the structure or the safety design of the device. Yealink is under no circumstances liable to consequences or legal issues caused by such changes.
- Please refer to the relevant laws and statutes while using the device. Legal rights of others should also be respected as well.

 **Environmental Requirements**

- Place the device at a well-ventilated place. Do not expose the device under direct sunlight.
- Keep the device dry and free of dust.
- Place the device on a stable and level platform.
- Please do not place heavy objects on the device in case of damage and deformation caused by the heavy load.
- Keep at least 10 cm between the device and the closest object for heat dissipation.
- Do not place the device on or near any inflammable or fire-vulnerable object, such as rubber-made materials.
- Keep the device away from any heat source or bare fire, such as a candle or an electric heater.
- Keep the device away from any household appliance with a strong magnetic field or electromagnetic field, such as a microwave oven or a refrigerator.

 **Operating Requirements**

- Do not let a child operate the device without guidance.
- Do not let a child play with the device or any accessory in case of accidental swallowing.
- Please only use the accessories provided or authorized by the manufacturer.
- The power supply of the device must meet the requirements of the input voltage of the device. Please use the provided surge protection power socket only.
- Before plugging or unplugging any cable, make sure that your hands are completely dry.
- Do not spill liquid of any kind on the product or use the equipment near water, for example, near a bathtub, washbowl, kitchen sink, wet basement or near a swimming pool.
- Do not tread on, pull, or over-bend any cable in case of malfunction of the device.
- During a thunderstorm, stop using the device and disconnect it from the power supply. Unplug the power plug and the Asymmetric Digital Subscriber Line (ADSL) twisted pair (the radio frequency cable) to avoid lightning strike.
- If the device is left unused for a rather long time, disconnect it from the power supply and unplug the power plug.
- When there is smoke emitted from the device, or some abnormal noise or smell, disconnect the device from the power supply, and unplug the power plug immediately. Contact the specified maintenance center for repair.
- Do not insert any object into equipment slots that is not part of the product or auxiliary product.
- Before connecting a cable, connect the grounding cable of the device first. Do not disconnect the grounding cable until you have disconnected all other cables.

**Cleaning Requirements**

- Before cleaning the device, stop using it and disconnect it from the power supply.
- Use a piece of soft, dry and anti-static cloth to clean the device.
- Keep the power plug clean and dry. Using a dirty or wet power plug may lead to electric shock or other perils.



## Appendix

### Appendix A - Time Zones

Time Zone	Time Zone Name
-11	Samoa
-10	United States-Hawaii-Aleutian, United States-Alaska-Aleutian
-9:30	French Polynesia
-9	United States-Alaska Time
-8	Canada(Vancouver,Whitehorse), Mexico(Tijuana,Mexicali), United States-Pacific Time
-7	Canada(Edmonton,Calgary), Mexico(Mazatlan,Chihuahua), United States-MST no DST, United States-Mountain Time
-6	Canada-Manitoba(Winnipeg), Chile(Easter Islands), Mexico(Mexico City,Acapulco), United States-Central Time
-5	Bahamas(Nassau), Canada(Montreal,Ottawa,Quebec), Cuba(Havana), United States-Eastern Time
-4:30	Venezuela(Caracas)
-4	Canada(Halifax,Saint John), Chile(Santiago), Paraguay(Asuncion), United Kingdom-Bermuda(Bermuda), United Kingdom(Falkland Islands), Trinidad&Tobago
-3:30	Canada-New Foundland(St.Johns)
-3	Argentina(Buenos Aires), Brazil(DST), Brazil(no DST), Denmark-Greenland(Nuuk)
-2:30	Newfoundland and Labrador
-2	Brazil(no DST)
-1	Portugal(Azores)
0	Denmark-Faroe Islands(Torshavn), GMT, Greenland, Ireland(Dublin), Morocco, Portugal(Lisboa,Porto,Funchal), Spain-Canary Islands(Las Palmas), United Kingdom(London)
+1	Albania(Tirane), Austria(Vienna), Belgium(Brussels), Caicos, Chad, Croatia(Zagreb), Czech Republic(Prague), Denmark(Kopenhagen), France(Paris), Germany(Berlin), Hungary(Budapest), Italy(Rome), Luxembourg(Luxembourg), Macedonia(Skopje), Namibia(Windhoek), Netherlands(Amsterdam), Spain(Madrid)
+2	Estonia(Tallinn), Finland(Helsinki), Gaza Strip(Gaza), Greece(Athens), Israel(Tel Aviv), Jordan(Amman), Latvia(Riga), Lebanon(Beirut), Moldova(Kishinev), Romania(Bucharest), Russia(Kaliningrad), Syria(Damascus), Turkey(Ankara), Ukraine(Kyiv, Odessa)
+3	East Africa Time, Iraq(Baghdad), Russia(Moscow)
+3:30	Iran(Teheran)
+4	Armenia(Yerevan), Azerbaijan(Baku), Georgia(Tbilisi), Kazakhstan(Aktau), Russia(Samara)
+4:30	Afghanistan(Kabul)
+5	Kazakhstan(Aqtobe), Kyrgyzstan(Bishkek), Pakistan(Islamabad), Russia(Chelyabinsk)
+5:30	India(Calcutta)
+5:45	Nepal(Katmandu)
+6	Kazakhstan(Astana, Almaty), Russia(Novosibirsk,Omsk)
+6:30	Myanmar(Naypyitaw)
+7	Russia(Krasnoyarsk), Thailand(Bangkok)
+8	Australia(Perth), China(Beijing), Russia(Irkutsk, Ulan-Ude), Singapore(Singapore)
+8:45	Eucla

<b>Time Zone</b>	<b>Time Zone Name</b>
+9	Japan(Tokyo), Korea(Seoul), Russia(Yakutsk,Chita)
+9:30	Australia(Adelaide), Australia(Darwin)
+10	Australia(Brisbane), Australia(Hobart), Australia(Sydney,Melbourne,Canberra), Russia(Vladivostok)
+10:30	Australia(Lord Howe Islands)
+11	New Caledonia(Noumea), Russia(Srednekolymsk Time)
+11:30	Norfolk Island
+12	New Zealand(Wellington,Auckland), Russia(Kamchatka Time)
+12:45	New Zealand(Chatham Islands)
+13	Tonga(Nukualofa)
+13:30	Chatham Islands
+14	Kiribati



## Appendix B - Menu Structure

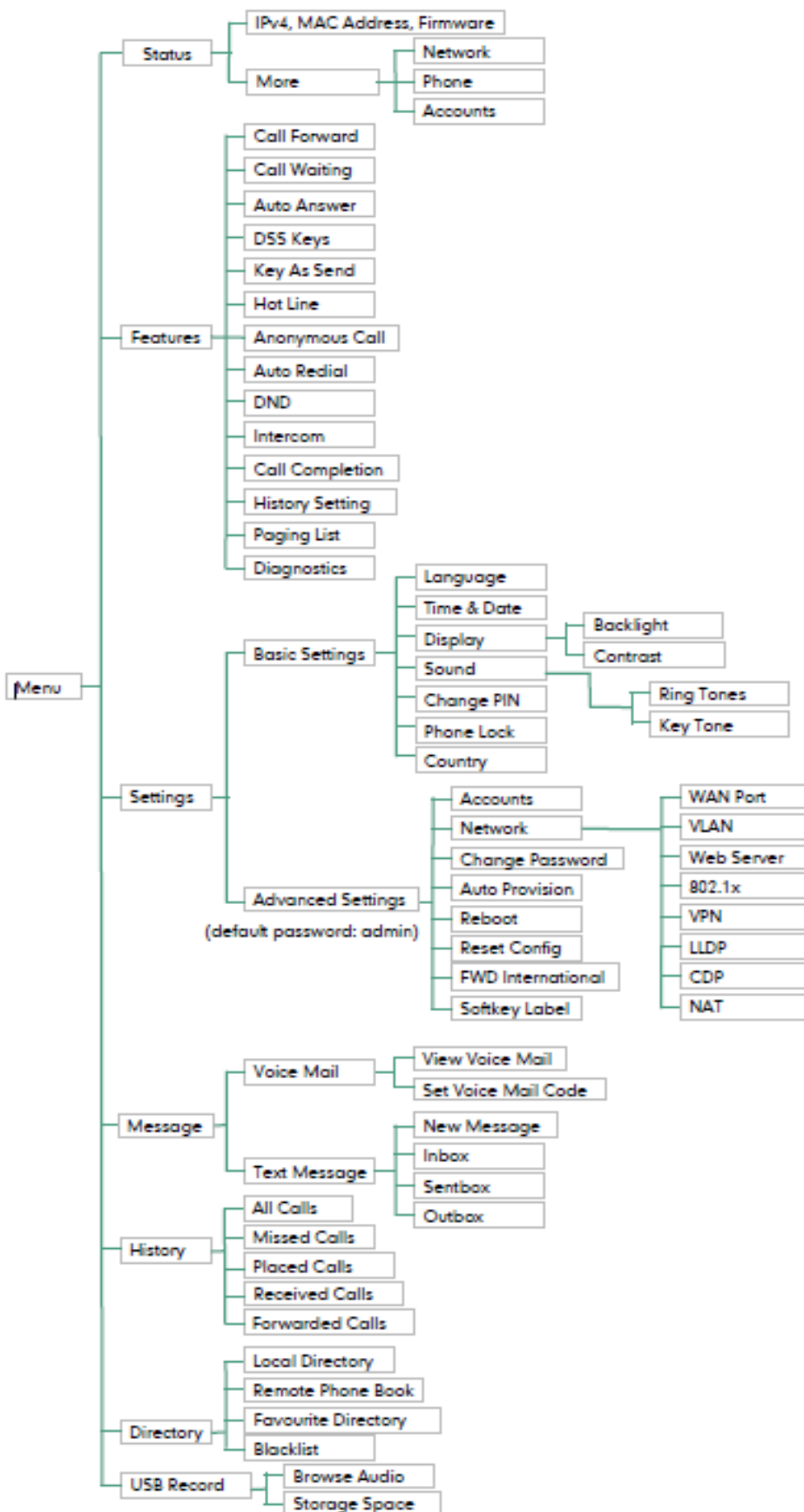

## Appendix C – Unavailable Features for PSTN

The following lists the main features not available for PSTN:

- Call Completion
- DND
- Call Forward
- Call Transfer
- Call Waiting
- Call Park
- Call Pickup
- Anonymous Call
- Anonymous Call Rejection
- Intercom
- Multicast Paging
- Music on Hold
- SCA
- BLA
- Messages
- Programable Keys (Prefix, SMS, NewSMS, Forward, Direct Pickup, XML Group, XML Directory, Intercom, Group Pickup, Multicast Paging, Paging List, XML Browser and Zero Touch)

# Index

## A

About This Guide [v](#)  
 Account Registration [58](#)  
 Adding Contacts [39](#)  
 Administrator password [29](#)  
 Anonymous Call [97](#)  
 Anonymous Call Rejection [98](#)  
 Answering Calls [73](#)  
 Appendix [155](#)  
 Appendix A - Time Zones [155](#)  
 Appendix B - Menu Structure [157](#)  
 Appendix C - Unavailable Features for PSTN [158](#)  
 Area Code [66](#)  
 Attaching Stand [11](#)  
 Audio Settings [32](#)  
 Auto Answer [75](#)  
 Auto Redial [76](#)

## B

Backlight [26](#)  
 Basic Network Settings [18](#)  
 Blacklist [45](#)  
 Block Out [67](#)  
 Bridged Line Appearance (BLA) [118](#)

## C

Call Completion [77](#)  
 Call Forward [82](#)  
 Call Mute [78](#)  
 Call History Management [49](#)  
 Call Hold/Resume [80](#)  
 Call Park [90](#)  
 Call Pickup [94](#)  
 Call and Conference Recording [99](#)  
 Call Transfer [85](#)  
 Call Waiting [87](#)  
 CE Mark Warning [vi](#)  
 Conference [87](#)  
 Configuring the PSTN Account [131](#)  
 Contact Management [35](#)  
 Contrast [26](#)  
 Copyright [v](#)  
 Customizing Your Phone [23](#)

## D

Declaration of Conformity [vi](#)  
 Deleting Contacts [42](#)  
 Dial Now [64](#)  
 Dial Plan [62](#)  
 Do Not Disturb (DND) [81](#)  
 Documentation [8](#)  
 Directory [36](#)

## E

Editing Contacts [41](#)  
 Emergency Number [67](#)  
 Ending Calls [74](#)  
 Entering Data and Editing Fields [20](#)

## F

Favorite Directory [46](#)

## G

General Settings [23](#)  
 Getting Started [9](#)

## H

Hardware Component Instructions [1](#)  
 Hotline [69](#)

## I

Icon Instructions [3](#)  
 Idle Screen [20](#)  
 Importing/Exporting Contact lists [43](#)  
 In This Guide [v](#)  
 Incoming Intercom Calls [105](#)  
 Intercom [102](#)

## K

Key As Send [30](#)  
 Key Tone [35](#)

## L

Language [27](#)  
 Idle Recording [102](#)  
 LED Instructions [5](#)  
 Limitation of Liability [151](#)  
 Live Dialpad [68](#)  
 Local Conference [87](#)  
 Local Directory [37](#)  
 Logo Customization [52](#)

## M

Message Waiting Indicator [126](#)  
 Messages [113](#)  
 Multicast Paging [104](#)  
 Music on Hold [112](#)

## N

Network Conference [89](#)  
 Network Connection [11](#)

## **P**

- Packaging Contents [9](#)
- Phone Installation [11](#)
- Phone Status [17](#)
- Phone User Interface [6](#)
- Phone Lock [30](#)
- Placing Calls [72](#)
- Placing Calls to Contacts [42](#)
- Power Saving [23](#)
- Programable Keys [52](#)

## **O**

- Outgoing Intercom Calls [104](#)
- Overview [1](#)

## **R**

- ReCall [78](#)
- Recent Call In Dialing [74](#)
- Recorded Files Playback [102](#)
- Redialing Numbers [74](#)
- Registration [20](#)
- Regulatory Notices [151](#)
- Remote Phone Book [48](#)
- Replace Rule [63](#)
- Ring Tones [33](#)

## **S**

- Safety Instructions [151](#)
- Search Source List in Dialing [51](#)
- Searching for Contacts [43](#)
- Selecting the Country for PSTN Use [132](#)
- Service Agreements [151](#)
- Setup Wizard [16](#)
- Shared Call Appearance (SCA) [113](#)
- Short Message Service (SMS) [123](#)
- System Customizations [52](#)

## **T**

- Time & Date [28](#)
- Time Zones [155](#)
- Troubleshooting [139](#)

## **U**

- Using Intercom [106](#)
- Using PC or Mobile Device with the Conference Phone [128](#)
- Using Your Phone with PSTN Account [131](#)

## **V**

- Voice Mail [125](#)
- Volume [32](#)

## **W**

- Warranty [vi](#)
- Web User Interface [6](#)
- WEEE Warning [vii](#)