

Yealink T58W Pro

User Guide



MOMENTUM

T E L E C O M

Table of Contents

Table of Contents	1
Before You Begin	13
Related Documentation	13
Summary of Changes	13
Changes for Release V86, Guide Version V86.11	13
Changes for Release V86, Guide Version V86.10	13
Changes for Release V85, Guide Version V85.1	14
Getting Started	15
Hardware Overview	15
VP59 Hardware	15
T58 Hardware	17
BTH58 Hardware	19
Power LED Indicator	19
Camera LED Indicator	20
LED Indicator of the BTH58	20
Screen and Icons	21
Control Center and Notification Center	21
Idle Screen	23
The Home Screen	23
The Second Idle Screen	25
The Third Idle Screen	25
Icons in the Status Bar	26
Line Key Icons	27
Navigating Menus and Fields	27
Entering Information	28
Using the Onscreen Keyboard	28
English (UK) Input Method	29
Google Pinyin Input Method	31
Using the Phone Keypad and Dial Pad	33
Call Features	34
Changing the Default Account	34
Placing Calls	34
Placing a Call from the Dialer	35
Placing Multiple Calls	35
Placing a Call with a Speed Dial Key	35
Placing a Call Back to the Last Incoming Number	36
Redialing a Number	36
Dialing a Hotline Number	36
Placing an International Call	37
Placing a Call from the Call History	37

Placing a Call from the Directory	37
Placing an Anonymous Call	37
Placing a Call from the Google Contacts	38
Answering Calls	39
Answering a Call	39
Answering a Call When in a Call	39
Answering a Call Automatically	40
Disabling Call Waiting	40
Switching Among the Handset, Speakerphone and Headset Modes	41
Audio-only/Video Call Selection	41
Placing an Audio-only/Video Call	41
Answering a Video Call	41
Switching between Video Call and Audio-only Call	42
Switching to the Audio-only Call	42
Initiating a Video Call	42
Switching Between Calls Screen and Idle Screen	42
Going Back to the Idle Screen during a Call	43
Returning to the Talking Screen	43
Options during a Video Call	43
Stopping Transmitting Video during a Call	43
Changing the Video Layout during a Call	43
Swapping Video	44
Changing the Video Layout to the Full Screen Mode	44
Hiding the Local Video Window	44
Previewing the Near-Site Video	44
Capturing a Screenshot	44
Capturing a Screenshot When the Phone is Idle	45
Capturing a Screenshot during a Call	45
Viewing the Latest Screenshot	45
Silencing or Rejecting Incoming Calls	46
Silencing a Call	46
Rejecting a Call Manually	46
Rejecting Anonymous Calls	46
Rejecting Calls with Do Not Disturb (DND)	47
Rejecting Calls with DND on All Lines	47
Rejecting Calls with DND on a Specific Line	48
Deactivating DND	48
Ending Calls	49
Redialing a Call Automatically	49
Muting/Unmuting Audio	50
Keep Mute	50
Holding and Resuming Calls	51
Holding a Call	51
Resuming a Held Call	51

Redirecting Incoming Calls	52
Forwarding All Incoming Calls to a Contact	52
Forwarding All Incoming Calls on All Lines	52
Forwarding All Incoming Calls on a Specific Line	53
Deactivating Call Forward	53
Forwarding an Incoming Call Manually	53
Forwarding Incoming Calls with a Forward Key	54
Diverting Calls to a Contact	54
Transferring Calls	54
Performing a Blind Transfer	55
Performing a Blind Transfer Normally	55
Performing a Blind Transfer Conveniently	55
Performing a Semi-Attended/Attended Transfer	56
Performing Transfer with a Transfer Key	57
Setting a Transfer Key	57
Performing a Blind Transfer Using a Transfer Key	57
Performing a Semi-attended/Attended Using a Transfer Key	58
Performing a Call Transfer by Selecting a Transfer Mode	58
Conference Calls	58
Local Conference	59
Setting Up a Local Conference Call	59
Merging Two Calls into a Conference	59
Creating a Hybrid Conference	60
Creating a Multi-Party Conference with a Conference Key	61
Setting a Conference Key	61
Initiating a Multi-Party Conference	61
Holding or Resuming a Conference Call	62
Muting or Unmuting a Conference Call	62
Splitting a Conference Call	62
Managing Conference Participants	62
Ending a Conference Call	62
Network Conference	62
Setting Up a Network Conference	63
Call Recording	63
Recording a Call	63
Recording a Conference	64
Setting a Mark When Recording a Call	64
Stopping a Recording	64
Checking Storage Space	65
Multicast Paging	65
Sending Multicast Paging	65
Setting a Multicast Paging Key	65
Sending a Paging by a Multicast Paging Key	66
Setting a Paging List Key	66

Setting a Paging Group	67
Sending Pages by a Paging List Key	67
Deleting a Paging Group	67
Receiving Multicast Paging	68
Managing a Paging Call	68
Sharing Content during a Call	68
Advanced Call Features	70
Using Call Completion	70
Call Pickup	71
Picking up a Call Directly	71
Picking up a Group Call Directly	72
Picking up a Call with a Pick Up Key	72
Picking up a Call with a Group Pickup Key	72
Call Park and Call Retrieve	73
Parking or Retrieving a Call in the FAC Mode	73
Parking a Call in the FAC Mode	73
Retrieving a Parked Call in the FAC Mode	74
Parking or Retrieving a Call in the Transfer Mode	74
Parking a Call in the Transfer Mode	74
Retrieving a Parked Call in the Transfer Mode	75
Parking or Retrieving a Call with a Park or Retrieve Key	75
State Indicator of the Park/Retrieve key	75
Parking a Call using a Park Key	75
Retrieving a Parked Call using a Retrieve Key	76
Busy Lamp Field (BLF)	76
State Indicator of Remote Line by BLF Key	77
Audio Alert for BLF Pickup	77
Setting an Alert Tone for Monitored Lines	77
Visual Alert for BLF Pickup	77
Setting a BLF Key	78
Picking up a Remote Call by BLF Key	78
Transferring a Call by BLF Key	78
Performing a Blind Transfer	78
Performing a Semi-attended/Attended Transfer	79
Parking or Retrieving a Call by BLF Key	79
Parking a Call to a Monitored Line	79
Retrieving a Parked Call	79
BLF List	79
State Indicator of Remote Line by BLF List Key	80
Audio Alert for BLF Pickup	80
Setting an Alert Tone for Monitored Lines	80
Visual Alert for BLF Pickup	80
Ring Type for BLF Parked Call Monitor	81
Setting an Alert Tone for the BLF Parked Call Monitor	81

Visual Alert for BLF Parked Call Monitor	81
Picking up a Remote Call by BLF List Key	82
Transferring a Call by BLF List Key	82
Performing a Blind Transfer	82
Performing a Semi-attended/Attended Transfer	82
Parking a Call by a BLF List Key	83
Retrieving a Call by a BLF List Key	83
Barging in an Active Call by BLF List Key	83
Retrieving a Call Parked to the Monitored Line	83
Shared Line	83
State Indicator of Shared Line	84
Placing Calls on a Shared Line	84
Answering Calls on a Shared Line	84
Placing a Call on Public Hold	84
Placing a Call on Private Hold	85
Retrieving a Held Call on a Shared Line	85
Barging in an Active Call on a Shared Line	85
Pulling a Shared Call on a Shared Line	86
Intercom	86
State Indicator of the Intercom key	87
Placing an Intercom Call	87
Picking up an Incoming Call of the Target Extension	87
Answering an Intercom Call	88
Video/Voice Mail	89
Setting the Voice Mail Code	89
Leaving Voice Mails	89
Listening to Voice Mails	89
Using the Hot Desking	90
Automatic Call Distribution (ACD)	90
State Indicator of ACD User	90
Logging into the ACD System	90
Changing the ACD Status	91
Directory	92
Local Directory	92
Managing the Local Directory Groups	92
Adding Contact Groups	92
Editing Contact Groups	92
Deleting Contact Groups	93
Managing the Local Directory Contacts	93
Adding Contacts	93
Viewing Contacts	93
Editing Contacts	94
Deleting a Contact	94
Deleting All Contacts	94

Moving a Local Directory Contact to Blocklist	94
Moving a Local Directory Contact to the Shared Directory	95
Searching for Contacts	95
Blocklist	96
Adding a Blocklist Contact	96
Viewing Blocklist Contacts	96
Editing a Blocklist Contact	96
Deleting Blocklist Contacts	97
Deleting a Blocklist Contact	97
Deleting All Blocklist Contacts	97
Moving a Blocklist Contact to the Local Directory	97
Mobile Contacts	98
Saving a Mobile Contact to the Local Directory	98
Searching for Mobile Contacts	98
Updating the Mobile Contacts	99
Google Contacts	99
Enabling the Google Contacts Feature	99
Viewing Google Contacts	100
Adding a Google Contact	100
Editing a Google Contact	100
Deleting a Google Contact	101
Searching for Google Contacts	101
Manually Updating the Google Contacts	101
Remote Phone Book	101
Searching for Remote Phone Book Contacts	102
Viewing Remote Phone Book Contacts	102
Saving a Remote Phone Book Contact to the Local Directory	102
Saving a Remote Phone Book Contact to the Blocklist	102
Call History	103
Call History Icons	103
Viewing History Records	103
Saving a History Record to Local Directory	103
Saving a History Record to Blocklist	103
Adding a History Record to Shared Directory	104
Deleting History Records	104
Deleting a Call Record	104
Deleting All Call Records	104
Disabling History Record	105
System Applications	106
Managing Applications and Widgets	106
Adding a Widget to the Idle Screen	106
Resizing a Widget	106
Moving an Application or Widget	107

Removing a Widget from the Idle Screen	107
Creating a Folder	108
Renaming a Folder	109
Managing Running Applications	109
APP Accounts	110
Adding APP Accounts	110
Syncing APP Account Information	111
Removing APP Accounts	111
File Manager	112
Viewing Files	112
Searching Files	112
Copying Files	113
Cutting Files (Moving Files)	113
Uploading Files	114
Deleting Files	114
Sharing Pictures/Videos/Audio via Bluetooth	115
Sharing Pictures/Videos/Audio via Email	115
Gallery	116
Viewing Pictures/Videos	116
Editing Pictures	117
Rotating Pictures	117
Adding a Filter for Pictures	118
Adding a Frame for Pictures	118
Cropping Pictures	118
Coloring Pictures	119
Setting a Picture as Wallpaper	119
Printing Pictures	119
Deleting Pictures/Videos	119
Taking a Picture/Video	120
Sharing Pictures/Videos via Bluetooth	120
Sharing Pictures/Videos via Email	122
Recorder	123
Recording Audio	123
Playing a Recorded Call	124
Pause/Resuming a Playback	124
Fast Forwarding/Rewinding a Playback	124
Stopping a Playback	124
Renaming the Recording	125
Uploading a Recording to Server	125
Deleting a Recording	125
Deleting All Recordings	125
Checking Storage Space	126
Camera	126
Inserting the USB Camera to the Phone	126

Taking Pictures	126
Recording Videos	127
Camera Settings	127
Email	127
Signing in Email	128
Sending Emails	128
Reading Emails	128
Deleting Emails	128
Marking/Printing Email	129
Adding Multiple Email Accounts	129
Using Email Widget	130
Sending Files via Email	130
Browser	130
Browsing a Web Page	131
Managing Bookmarks	131
Adding a Web Page to the Bookmarks Library	131
Accessing a Web Page from the Bookmarks Library	131
Editing a Bookmark	132
Deleting a Bookmark	132
Setting a Home Page	133
Clearing the Navigation History	133
Modifying the Browser Settings	133
Calendar	133
Signing Into Calendar	134
Creating an Event	134
Checking Events	135
Modifying the Calendar Settings	135
Calculator	136
Clock	136
Alarm	136
Setting an Alarm Clock	136
Editing an Alarm Clock	137
Deleting an Alarm Clock	137
Setting the Alarm Parameters	137
Clock	138
Adding the Clock of Other Cities	138
Configuring the Clock Display Mode	138
Setting a Timer	138
Setting a Stopwatch	139
Customizing Your Phone	140
Changing the Administrator Password	140
Wallpaper	140
Changing Wallpaper on Idle Screen	140
Adding a Wallpaper from a USB Flash Drive	141

Screen Saver	141
Changing the Waiting Time for Screen Saver	141
Setting the Screen Saver Type	141
Changing the Screen Backlight and Time	141
Changing the Language	143
Changing the Input Method	143
Time & Date	144
Setting the Time and Date Manually	144
Changing the Time and Date Format	144
Setting a Key as Send	144
Phone Lock	145
Setting the Phone Lock	145
Locking Your Phone Manually	145
Unlocking Your Phone	146
Changing Your Phone Unlock PIN	146
Line Keys	146
Assigning Functionality to a Line Key	146
Changing the Locations of the Line Keys	147
Deleting a Line Key	148
Audio Settings	150
Adjusting the Volume	150
Setting the Ring Tone	150
Setting a Ring Tone for the Phone	150
Setting a Ring Tone for an Account	150
Setting a Ring Tone for a Group	151
Setting a Ring Tone for a Contact	151
Disabling the Key Tone	151
Enabling Touch Tone	151
Configuring Notification Sound	152
Enabling Silent Mode	152
Bluetooth	153
Activating the Bluetooth Mode	153
Pairing and Connecting the Bluetooth Headset	153
Pairing and Connecting the Bluetooth-enabled Mobile Phone	154
Pairing and Connecting two Bluetooth Devices	155
Syncing the Mobile Contacts to the Phone	155
Enabling the Mobile Contacts Sync Feature	156
Viewing Your Mobile Contacts	156
Handling a Mobile Phone Call on the Phone	156
Configuring the Phone Audio Feature	157
Configuring the Media Audio Feature	157
Changing Your Phone's Bluetooth Name	157
Disabling Bluetooth Device Discovery	158

Renaming the Paired Bluetooth Device	158
Unpairing the Bluetooth Device	158
Sending Files via Bluetooth	159
Receiving Files via Bluetooth	159
Disconnecting the Bluetooth Device	159
Deactivating the Bluetooth Mode	159
Wireless Network	161
Activating the Wi-Fi Mode	161
Connecting to the Wireless Network	161
Connecting to an Available Wireless Network Manually	161
Connecting to the Wireless Network Using Wi-Fi Protected Setup	162
Adding a Wireless Network Manually	162
Viewing the Wireless Network Information	163
Disconnect from a Wireless Network	163
Deactivating the Wi-Fi Mode	163
Wireless Access Point	164
Enabling the Wireless Access Point	164
Configuring Wireless Access Point	164
Viewing the Connected Devices	164
Adding Connected Devices to the Blocklist	164
Removing Devices from the Blocklist	165
Disabling the Wireless Access Point	165
Optional Accessories with Your Phone	166
Headset	166
Connecting the Analog Headset	166
Bluetooth Headset	166
USB Headset	166
Using Headsets	167
Managing Yealink USB Headsets	167
Enabling Local Ringtone	167
Expansion Module and Your Phone	167
Connecting the Expansion Module	168
Assigning the Features for Ext Keys	168
Adjusting the Screen Saver of Expansion Module	168
Adjusting the Backlight of Expansion Module	168
Changing the EXP Wallpaper from Phone	168
Adding an EXP Wallpaper from a USB Flash Drive	168
Connecting the Bluetooth Handset (BTH58)	169
Using Your Phone with PSTN Account	170
Connecting the Expansion PSTN Box CPN10	170
Configuring the PSTN Account	170
Selecting the Country for PSTN Use	170

Configuring the Flash Time	171
Basic Call Features	171
Conference	172
Recording Using a USB Flash Drive	172
Unavailable Features for PSTN	172
Using DECT Handsets with Your Phone	173
Attaching the DECT USB Dongle DD10K	173
Handset Registration	173
Setting the Phone to the Handset Registration Mode	173
Registering a Handset to the Phone	174
De-registering a Handset on the Handset	174
De-registering a Handset on the Phone	174
DECT Intercom	175
Configuring Auto Intercom	175
Placing a DECT Intercom Call on the Handset	175
Placing a DECT Intercom Call on the Phone	175
Placing a DECT Intercom Call with a DECT Intercom Key	176
Performing a Blind Transfer to the Handset	176
Merging the DECT Intercom Call with SIP Call into a Conference	176
Repeater Mode	177
Enabling the Repeater Mode	177
Setting the Phone to the Repeater Registration Mode	177
Registering a Repeater	177
Satellite Mode	178
Selecting a Handset to Use the Satellite Mode	178
Push an Active Call to the Handset	178
Pull an Active Call from the Handset	179
Shared Directory	179
Adding Shared Contacts	179
Viewing Shared Contacts	180
Editing Shared Contacts	180
Deleting a Shared Contact	180
Deleting All Shared Contacts	180
Searching for Shared Directory Contacts	180
Moving a Shared Contact to the Blocklist Directory	181
Saving a Shared Contact to the Local Directory	181
Placing a Call from the Shared Directory	181
Renaming the Handset	182
Locating a Handset	182
Changing Base PIN	182
Maintaining Your Phone	183
Investigating Warnings	183
Clearing Warning Icon	183

Diagnosing the Network	183
Rebooting Your Phone	184
Resetting to Factory Settings	184
Updating the Phone Configuration	184
Clearing User's Personalized Configuration Settings	185
Appendix - Menu Structure	186

Before You Begin

This guide provides information you need to quickly use your new phone.

Firstly, verify with your system administrator that the IP network is ready for phone configuration. Also, be sure to read the Quick Start Guide which can be found in your phone package before you set up and use the phone. As you read this guide, keep in mind that some features are only configurable by your system administrator or determined by your phone environment. As a result, some features may not be enabled or may be operated differently on your phone. Additionally, the examples and graphics in this guide may not directly reflect what is displayed or is available on your phone screen.

Note: This guide mainly takes T58A phones as an example.

Related Documentation

You can view more types of documents to make the phone to perform more functions.

You can obtain additional information on the following phones from Yealink Support:

- [Flagship Smart Video Phone VP59](#)
- [Smart Business Phone SIP-T58A](#)
- [Smart Business Phone SIP-T58A with Camera](#)
- [Smart Business Phone T58W](#)
- [Smart Business Phone T58W Pro](#)
- [Smart Business Phone T58W with Camera](#)
- [Smart Business Phone T58W Pro with Camera](#)

The following types of related documents are available on each support page on [Yealink support page](#):

- Release Notes, which details bug fixes and feature enhancements when an update is released.
- Quick Start Guide, which describes how to assemble your phone.
- Wall Mount Installation Guide, which provides detailed instructions on how to use an optional wall mount bracket to mount your phone on the wall. It is only applicable to T58A/T58W phones.
- Administrator Guide, which provides detailed information on how to configure phone features for the system administrator.

You can also view other user documents which provide descriptions and examples for phone settings and features on the [Yealink support page](#).

Summary of Changes

This section describes the changes to this guide for each release and guide version.

Changes for Release V86, Guide Version V86.11

Documentations of the newly released T58W phones have also been added.

The following sections are new for this version:

- [BTH58 Hardware](#)
- [LED Indicator of the BTH58](#)
- [Connecting the Bluetooth Handset \(BTH58\)](#)

Changes for Release V86, Guide Version V86.10

The following sections are new for this version:

- [Managing Yealink USB Headsets](#)

Major updates have occurred to the following sections:

- [Placing an Anonymous Call](#)

*You can select **All On** to turn on local anonymous for all lines.*

Changes for Release V85, Guide Version V85.1

The following sections are new for this version:

- [Wireless Access Point](#)
- [Creating a Multi-Party Conference with a Conference Key](#)
- [Using Your Phone with PSTN Account](#)
- [Pairing and Connecting two Bluetooth Devices](#)

Major updates have occurred to the following sections:

- [Control Center and Notification Center](#)
- [Icons in the Status Bar](#)
- [Wireless Network](#)
- [Using DECT Handsets with Your Phone](#)

Getting Started

Before you use your phone, take some time to get familiar with its features and user interface.

The terms "the phone" and "your phone" refer to any of the IP phones. Unless specifically noted in this guide, all phone models are operated in similar ways.

Topics

- [Hardware Overview](#)
- [Screen and Icons](#)
- [Navigating Menus and Fields](#)
- [Entering Information](#)

Hardware Overview

Understanding the phone hardware helps you easily use the phone's features.

Topics

- [VP59 Hardware](#)
- [T58 Hardware](#)
- [BTH58 Hardware](#)
- [Power LED Indicator](#)
- [Camera LED Indicator](#)
- [LED Indicator of the BTH58](#)

VP59 Hardware

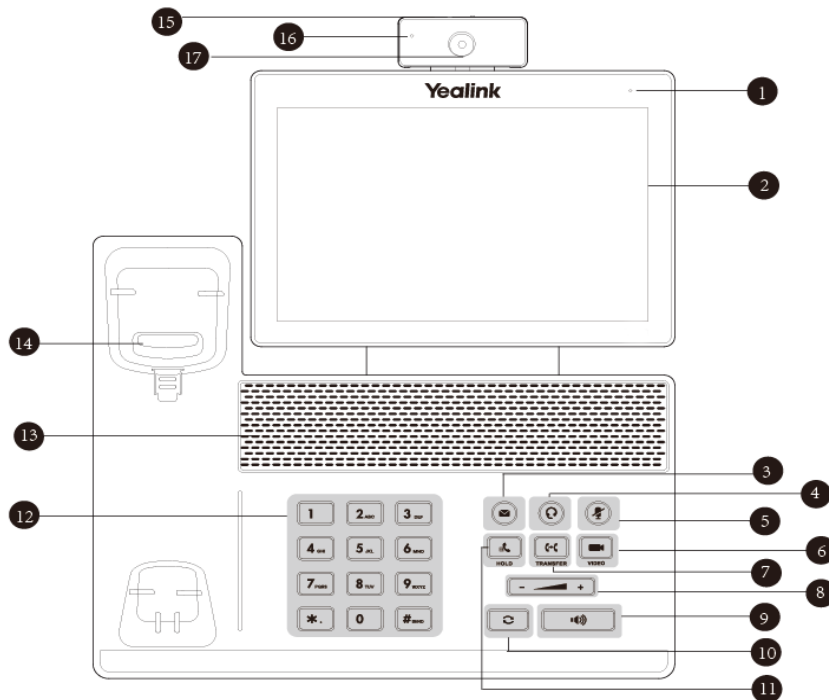

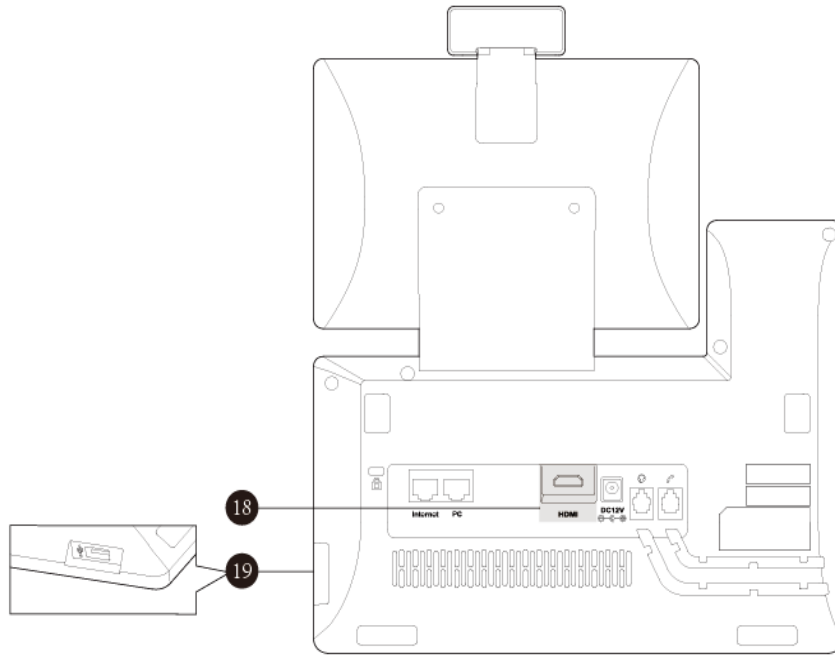

No.	Item	Description
1	Power LED Indicator	Indicates call status, message status and phone's system status.
2	Touch Screen	Allows you to select items and navigate menus on the touch-sensitive screen. Tap to select and highlight screen items. Shows information about calls, messages, time, date and other relevant data.
3	MESSAGE Key	<ul style="list-style-type: none"> • Accesses voice mails. • Captures screenshots during a video call.
4	HEADSET Key	Toggles and indicates the headset mode. The key LED glows green when headset mode is activated.
5	MUTE Key	Toggles and indicates mute feature. The key LED glows red when the call is muted.
6	VIDEO Key	<ul style="list-style-type: none"> • Allows you to preview local-site video when the phone is idle. • Controls the transmission of video images during calls and conferences.
7	TRANSFER Key	Transfers a call to another party.
8	Volume Key	Adjusts the volume of the handset, headset and speaker.
9	Speakerphone Key	Toggles and indicates the hands-free (speakerphone) mode. The key LED glows green when the hands-free (speakerphone) mode is activated.
10	REDIAL Key	Redials a previously dialed number.
11	HOLD Key	Places a call on hold or resumes a held call.
12	Keypad	Provides the digits and special characters in context-sensitive applications.
13	Speaker	Provides hands-free (speakerphone) audio output.
14	Hookswitch	<ul style="list-style-type: none"> • Picking up the handset from the handset cradle, the hookswitch bounces and the phone connects to the line. • Laying the handset on the handset cradle, the phone disconnects from the line.
15	Privacy Shutter	Covers and uncovers the camera. When the camera is switched off, the video image turns

No.	Item	Description
		to be black.
16	Camera LED indicator	Indicates video call status and camera status.
17	Camera Lens	2 Mega-pixel camera. Provides near-site video. The best distance between camera and the images you want to capture should be within 0.35 meters (1 foot) to 2 meters (6 feet).
18	HDMI Port	Allows you to connect an external monitor (optional) to your phone and the video image captured from camera (both near site and far site) will also be shown on the external monitor during a video call.
19	USB2.0 Port	Allows you to connect an optional USB device (for example, USB flash drive, DD10K) to your phone.

T58 Hardware

The Yealink USB camera CAM50 is optional for T58A/T58W/T58W Pro phones.

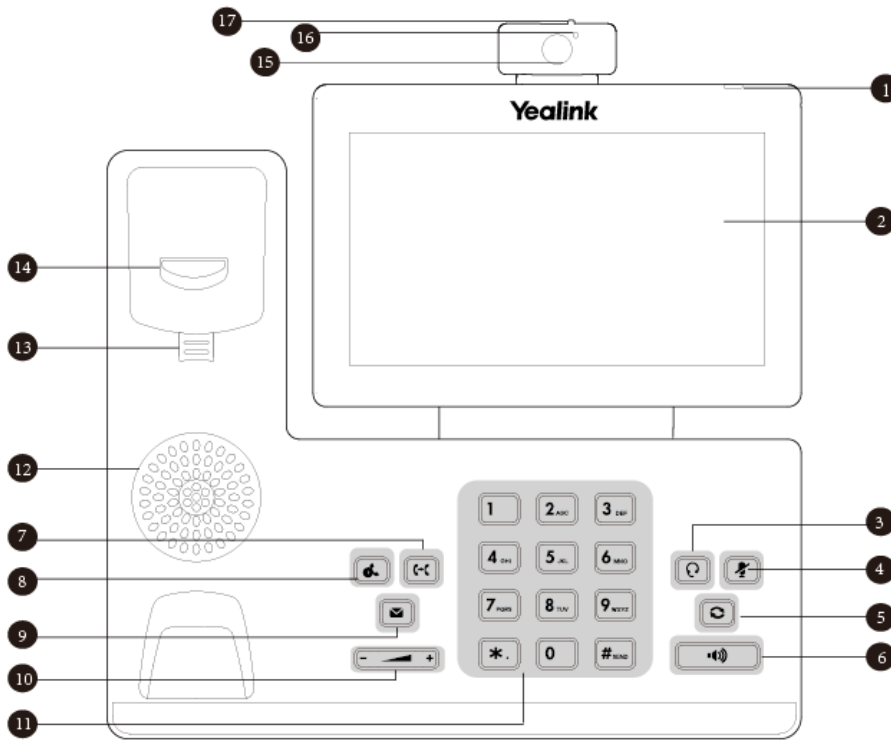

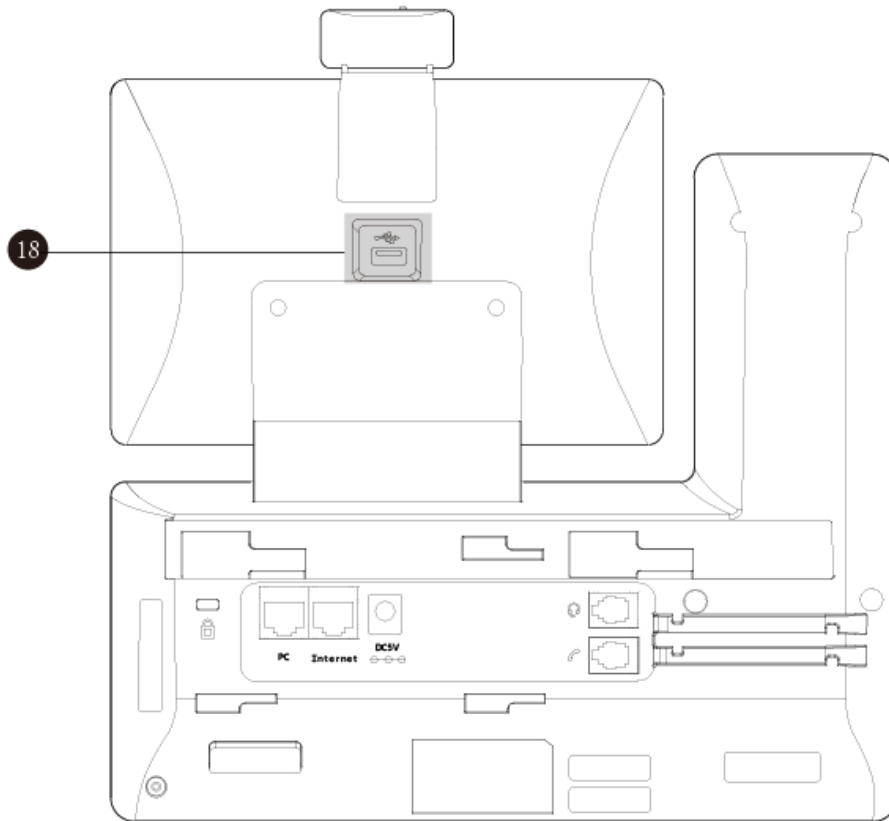

No.	Item	Description
1	Power LED Indicator	Indicates call status, message status and phone's system status.
2	Touch Screen	Allows you to select items and navigate menus on the touch-sensitive screen. Tap to select and highlight screen items. Shows information about calls, messages, time, date and other relevant data.
3	HEADSET Key	Toggles and indicates the headset mode. The key LED glows green when headset mode is activated.
4	MUTE Key	Toggles and indicates mute feature. The key LED glows red when the call is muted.
5	REDIAL Key	Redials a previously dialed number.
6	Speakerphone Key	Toggles and indicates the hands-free (speakerphone) mode. The key LED glows green when the hands-free (speakerphone) mode is activated.
7	TRANSFER Key	Transfers a call to another party.
8	HOLD Key	Places a call on hold or resumes a held call.
9	MESSAGE Key	Accesses voice mails.
10	Volume Key	Adjusts the volume of the handset, headset, and speaker.
11	Keypad	Provides the digits and special characters in context-sensitive applications.
12	Speaker	Provides hands-free (speakerphone) audio output.
13	Reversible Tab	Secures the handset in the handset cradle when the phone is mounted vertically. For more

No.	Item	Description
		information on how to adjust the reversible tab, refer to Yealink Wall Mount Quick Installation Guide for Yealink IP Phones .
14	Hookswitch (not for T58W)	<ul style="list-style-type: none"> Picking up the handset from the handset cradle, the hookswitch bounces and the phone connects to the line. Laying the handset down on the handset cradle, the phone disconnects from the line.
15	Camera Lens	2 Mega-pixel camera (5 Mega-pixel camera for T58W). Provides near-site video. The better distance between camera and images you want to capture should be in the range of 0.35 meters (1 foot) to 2 meters (6 feet).
16	Camera LED Indicator	Indicates video call status and camera status.
17	Privacy Shutter	Covers and uncovers the camera. When the camera is switched off, the video image is black.
18	USB2.0 Port	Allows you to connect an optional USB device (for example, USB flash drive) to your phone.

BTH58 Hardware

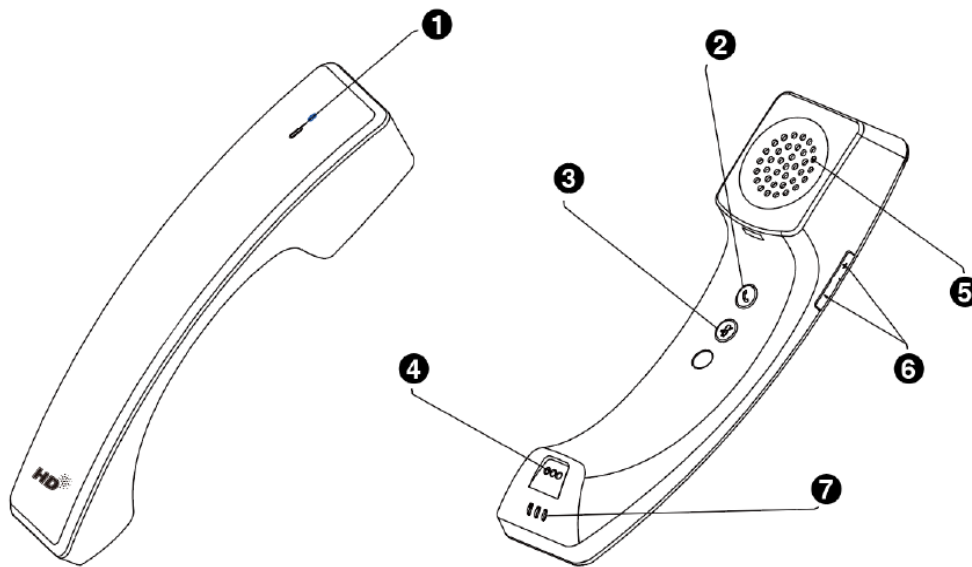

No.	Item	Description
1	LED Indicator	Indicates handset statuses.
2	Hookswitch Key	<ul style="list-style-type: none"> Answer/Reject/Hang up a call. Long press 3s to power on the handset. Long press 8s to power off the handset.
3	Mute Key	Toggles and indicates the mute feature.
4	Microphone	Provides audio input during calling.
5	Speaker	Provides audio output during calling.
6	Volume Control Keys	Adjust the volume of the handset and the phone.
7	Charging Contacts	Place the handset on the phone handset cradle, the handset starts charging.

Power LED Indicator

The power LED indicator indicates the call and message status.

LED Status	Description
Solid red	The phone is initializing.
Fast-flashing red (0.3s)	The phone is ringing.
Slowly-flashing red (1s)	The phone receives a voice mail.
Solid red for 0.5s and off for 3s alternately	The phone enters the power-saving mode.

Note: The above introduces the default LED status. Your system administrator can configure the status of the power LED indicator.

Camera LED Indicator

The camera LED indicator indicates the phone and camera status.

LED Status	Description
Solid green	The phone is powered on and the camera is properly connected to the phone. The camera is idle. The phone receives an audio-only call.
Flashing green	The phone receives a video call.
Solid red	There is an active video call. The video call is muted. The video call is held.
Slowly-flashing red	The shutter switch is open, but the near-site video is stopped transmitting during a video call. The video call is placed on hold.
Off	The phone is powered off. The camera is not properly connected to the phone. The shutter switch is closed.

LED Indicator of the BTH58

LED Status	Description
Solid green	The handset charges fully.
Green for 1s	The handset powers on.
Fast-flashing orange	The handset is pairing with the phone.
Slowly-flashing orange	The handset is reconnecting.
Orange for 2s	The handset is connected to the phone.
Fast-flashing red	Receives a call and the handset is not on the phone handset cradle.
Slowly-flashing red	The handset's battery is low.

LED Status	Description
Solid red	The handset is charging.
Red for 3s	The handset powers off automatically.
Red and green flashing alternately	The handset is finding the phone.
Red, green and orange flashing alternately	The handset is upgrading.

Screen and Icons

The user screens and icon indicators can help you navigate and understand the important information on the phone's status.

Topics

[Control Center and Notification Center](#)

[Idle Screen](#)

[Icons in the Status Bar](#)

[Line Key Icons](#)

Control Center and Notification Center

Control center or notification center allows you to access some features or view important notifications quickly.

Procedure

1. Swipe down from the top of the screen.

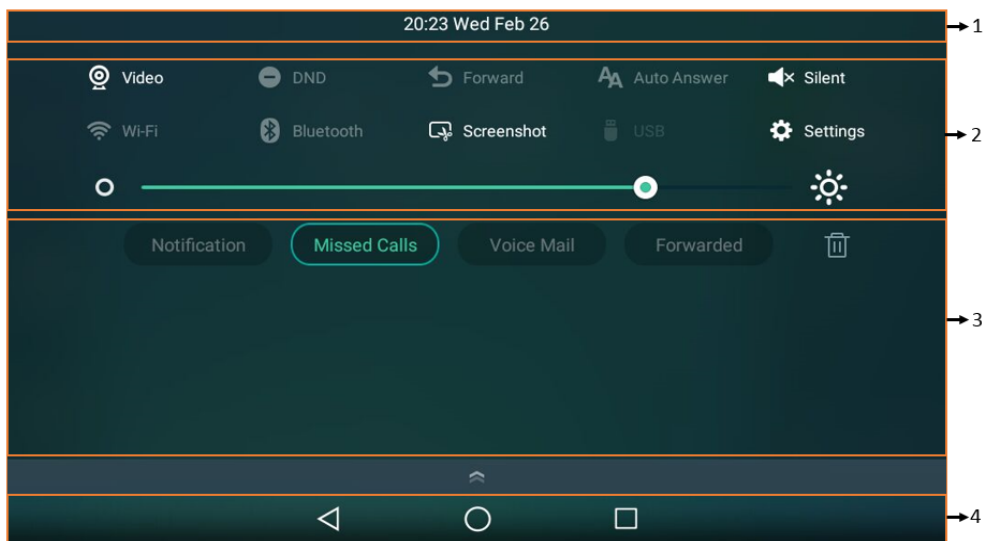



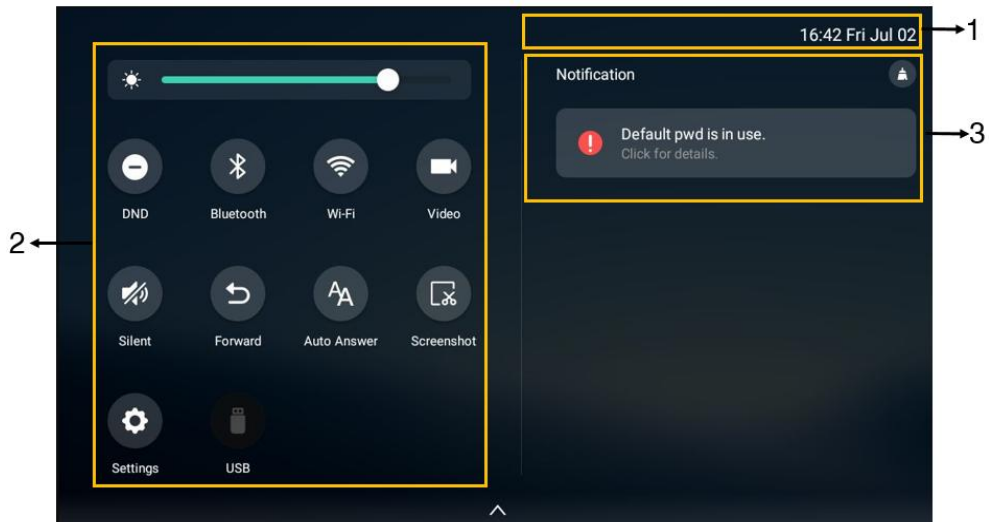

T58A/VP59



T58W

No.	Name	Description	
1	Time and date	Display the phone's time and date.	
2	Control Center	Video	<ul style="list-style-type: none"> • Tap to access the Camera when the phone is idle. • Tap to stop transmitting video during a video call.
		DND	Tap to turn on/off DND quickly.
		Forward	Tap to enter Call Forward setting screen.
		Auto Answer	Tap to enter Auto Answer setting screen.
		Silent	Tap to turn on/off Silent quickly.
		Wi-Fi	<ul style="list-style-type: none"> • Tap to turn on/off Wi-Fi quickly. • Long tap to enter the Wi-Fi setting screen.
		Bluetooth	<ul style="list-style-type: none"> • Tap to turn on/off Bluetooth quickly. • Long tap to enter the Bluetooth setting screen.
		Screenshot	Tap to capture a screenshot.
		USB	Tap to access the File Manager to manage the files in the USB flash drive.
		Settings	Tap to enter the Settings screen.
3	Notification Center	Backlight	Drag the slider to adjust the screen brightness quickly.
		<ul style="list-style-type: none"> • Tap Notification/Missed Calls/Voice Mail/Forwarded to view the corresponding notification list. (not available to T58W) • Tap the desired notification message to view the details. • Swipe left or right to delete a specific notification. 	

No.	Name	Description
		<ul style="list-style-type: none"> Tap  /  to delete all notifications.
4	Android Keys	<ul style="list-style-type: none">  : tap to go back to the previous screen.  : tap to return to the idle screen.  : tap to view and manage the list of recently used applications.

You can swipe up from the bottom of the screen to hide this screen.

Idle Screen

The phone has three idle screens by default. You can swipe left or right to switch among different idle screens.

You can add a new idle screen by moving an application or widget to the right side of the third idle screen. This idle screen will be deleted automatically if there is no application or widget on it.

Topics

- [The Home Screen](#)
- [The Second Idle Screen](#)
- [The Third Idle Screen](#)

Related Topic

- [Managing Applications and Widgets](#)

The Home Screen

On the home screen, you can view the phone's current state, add line keys (not available to T58W), and access the dialing, Directory, and History screens.

For T58A/VP59:

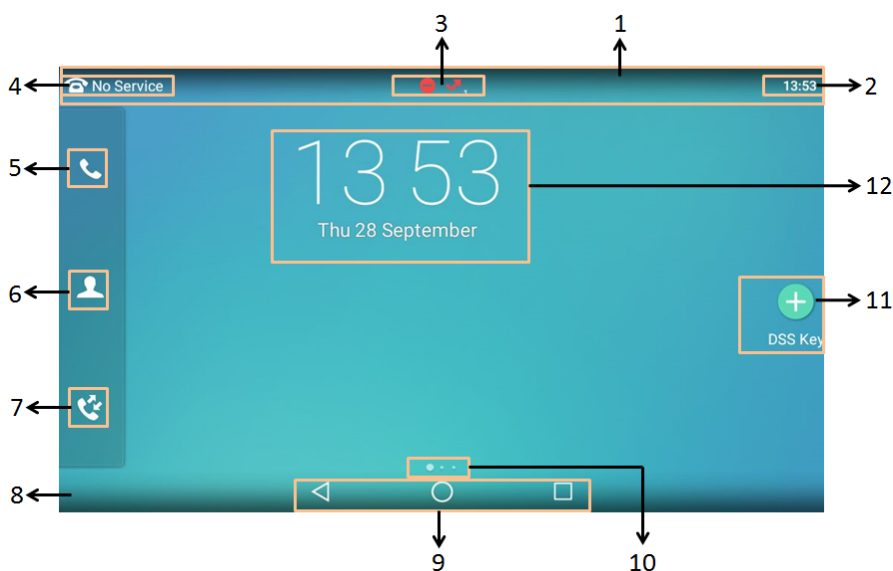

No.	Name	Description
1	Status Bar	Displays the phone's default account, icons and time.
2	Time	The phone's time is displayed on the right of the status bar.
3	Icons	Icons are displayed in the middle of the status bar.
4	Default account	The label of the default account is displayed on the left of the status bar. If there is no account registered on the IP phones, this field will display No Service .
5	Phone Dialer	Tap to enter the dialing screen.
6	Directory	Tap to enter the Directory screen and view contacts.
7	History	Tap to enter the History screen and view call history.
8	Wallpaper	Shows the specified wallpaper, which can be customized.
9	Android Keys	<ul style="list-style-type: none"> ◁ : tap to go back to the previous screen. ○ : tap to return to the idle screen. □ : tap to view and manage the list of recently used applications.
10	Screen Indicator	Indicates which idle screen is displayed.
11	DSS Key (Dss-key)	Tap to add a line key, and then the line key list will be displayed on the right of the home screen.
12	Digital Clock Widget	Displays the phone's time and date.

For T58W:



No.	Name	Description
1	Status Bar	Displays the phone's default account, icons and time.
2	Default account	The label of the default account is displayed on the left of the status bar. If there is no account registered on the IP phones, this field will display No Service .
3	Icons	Icons are displayed on the right of the status bar.

No.	Name	Description
4	Phone Dialer	Tap to enter the dialing screen.
5	Directory	Tap to enter the Directory screen and view contacts.
6	History	Tap to enter the History screen and view call history.
7	Screen Indicator	Indicates which idle screen is displayed.
8	Wallpaper	Shows the specified wallpaper, which can be customized.
9	Digital Clock Widget	Displays the phone's time and date.
10	Dsskey List	The line key list is displayed on the right of the home screen.

The Second Idle Screen

The second idle screen displays phone's system applications by default.

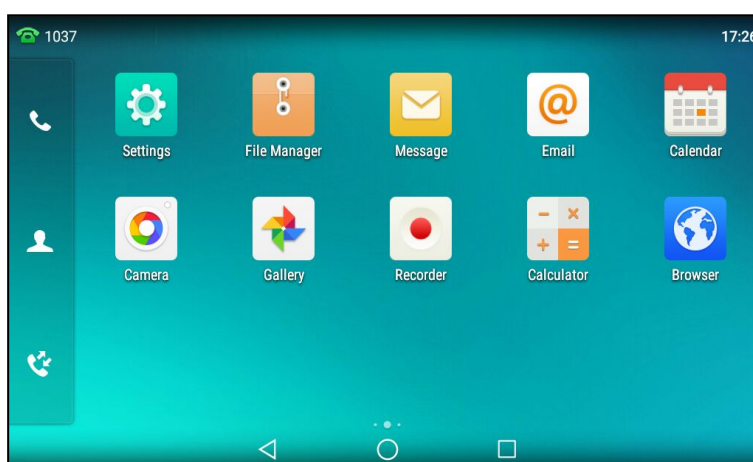

No.	Application	Description
1	Settings	To access phone settings and features.
2	File Manager	To manage files in the internal SD card as well as USB flash drive.
3	Message	To access the video/voice mails or leave video/voice mails for someone.
4	Email	To send and receive emails.
5	Calendar	You can use this application as a reminder or to manage and arrange your events.
6	Camera	To take pictures or record videos.
7	Gallery	To view photos and videos.
8	Recorder	To record audio.
9	Calculator	To quickly calculate numbers
10	Browser	To present and explore content on the World Wide Web.

The Third Idle Screen

The third idle screen displays the calendar and email widgets by default.

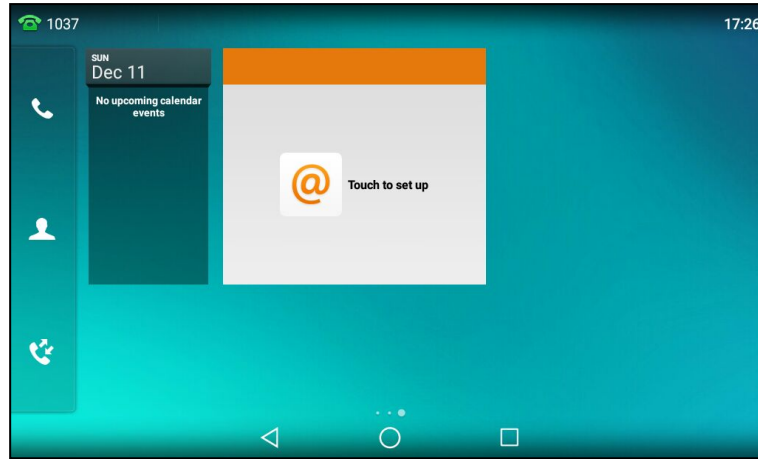







No.	Widget	Description
1	Calendar	Displays the data and upcoming events.
2	Email	Displays email list of the specified folder.

Icons in the Status Bar

The icons in the status bar help you easily get the current phone status, such as call and message status.



















Icons	Description	Icons	Description
	Wired network is unavailable		Bluetooth mode is on
	Speakerphone (hands-free) mode		Bluetooth headset is both paired and connected
	Handset mode		Bluetooth-enabled mobile phone paired and connected
	Headset mode		Wi-Fi mode is on
	Voice Mail		Wi-Fi signal strength from weak to strong after connecting successfully
	Auto Answer		The USB flash drive is detected
	Do Not Disturb (DND)		Screenshot captured
	Keep Mute		Downloading file
	Silent Mode		Uploading file
	Phone Lock		Upcoming alarm
	Missed Calls		Unread email

Icons	Description	Icons	Description
	Always Forward		Phone Warning
	No Answer Forward		PSTN box is detected
	Busy Forward		Wireless Access Point







Line Key Icons

By viewing the line key icons, you can easily get the function of the line key.

Icon indicators (associated with line key features)

Icons	Description	Icons	Description
	Hold		DND
	Voice Mail		SMS
	Direct Pickup		Group Pickup
	Conference		Forward
	Transfer		Recall
	Record		Recording in process
	Multicast Paging Paging List		Hot Desking
	Phone Lock		Directory
	Speed Dial		DECT Intercom

Icon indicators (associated with line)







Icons	Description	Icons	Description
	The private line registers successfully.		The shared/bridged line registers successfully.
	Registering.		Register failed.
	DND is enabled on this line.		Call forward is enabled on this line.

Navigating Menus and Fields

You can use different gestures on the touch screen to perform various operations.

Procedure

1. To operate your phone using gestures, follow these tips:

Gesture		Action
Tap		Touch an item on the screen with your finger, and then lift your finger.
Long Tap		Touch an item for about 2 seconds without lifting your finger from the screen till an action occurs.
Swipe		Touch and move. When you want to scroll quickly, swipe your finger across the screen, either up, down, left or right.
Drag		Touch and hold, then move. To stop scrolling, stop the dragging motion.
Pinch Open		Touch the screen with two or more fingers, and then move the fingers away from each other (stretch).
Pinch Close		Touch the screen with two or more fingers, and then move the fingers towards each other (pinch).

Entering Information

The phone provides onscreen keyboard, phone keypad and dial pad to enter data. Phone keypad and dial pad provide a standard key layout, which enables you to use existing or familiar key positions.

Topics



[Using the Onscreen Keyboard](#)



[Using the Phone Keypad and Dial Pad](#)

Using the Onscreen Keyboard

The phone supports two kinds of input methods: English (UK) and Google Pinyin for the onscreen keyboard. You can enter information into text fields using the touch screen.

When you use the onscreen keyboard, the following things you need to know:

If you want to	Action
Position the cursor.	Tap to the position.
Select all characters.	<ol style="list-style-type: none"> 1. Long tap the entered character(s). 2. Do one of the following: <ul style="list-style-type: none"> • Tap SELECT ALL on the top of the phone screen. • Drag  to select all characters.
Cut/Copy characters.	<ol style="list-style-type: none"> 1. Long tap the entered character(s). 2. Drag  to select the characters you want to cut/copy.

If you want to	Action
	<ol style="list-style-type: none"> 3. Tap CUT/COPY on the top of the phone screen. 4. Long tap the desired field. 5. Tap PASTE.
Delete more characters at a time.	<ul style="list-style-type: none"> • Long tap the entered character(s). Drag  to select the characters you want to delete. Tap . • Long tap .
Replace characters.	<ol style="list-style-type: none"> 1. Drag your finger to highlight the characters you want to replace. 2. Tap the desired character.

Related Topic

[Changing the Input Method](#)

Topics



[English \(UK\) Input Method](#)

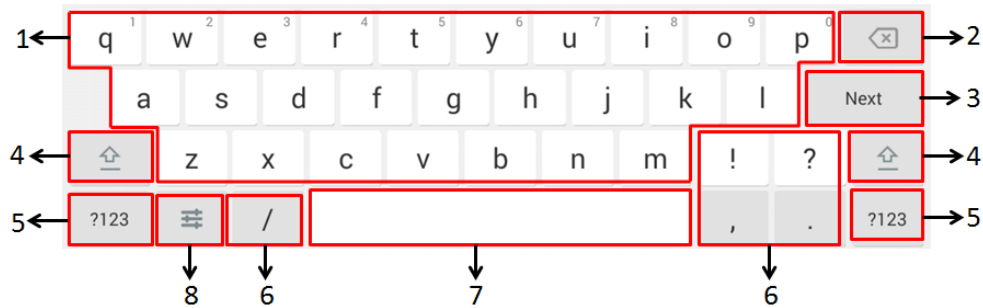

[Google Pinyin Input Method](#)

English (UK) Input Method

You can use the English (UK) input method to enter information.





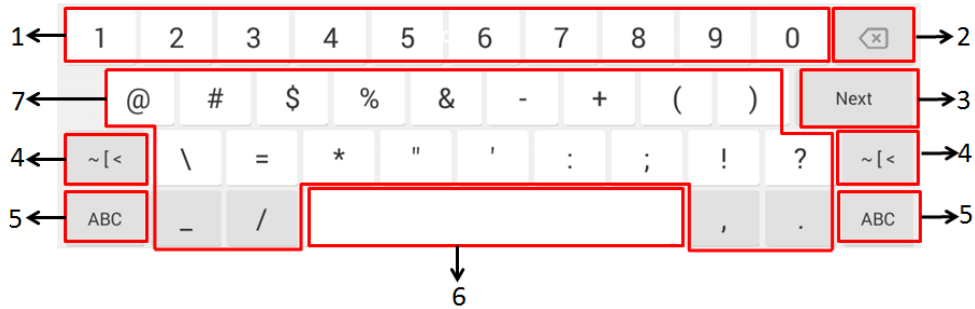

No.	Item	Description								
1	26 English Letters	<ul style="list-style-type: none"> • Tap to enter letters. • Long tap a key then slide to choose one of the options to enter an alternate character. 								
2	Delete Key	<ul style="list-style-type: none"> • Tap to delete the entered characters one by one. • Long tap to delete two or more characters. 								
3	Label automatically to identify the context-sensitive features.	<table border="1"> <tr> <td data-bbox="453 1476 603 1509">Next Key</td> <td data-bbox="603 1476 1423 1509">Tap to go to the next field.</td> </tr> <tr> <td data-bbox="453 1509 603 1543">Done Key</td> <td data-bbox="603 1509 1423 1543">Tap to confirm the settings.</td> </tr> <tr> <td data-bbox="453 1543 603 1606">Send Key</td> <td data-bbox="603 1543 1423 1606">Tap to dial out the number.</td> </tr> <tr> <td data-bbox="453 1606 603 1655">Go Key</td> <td data-bbox="603 1606 1423 1655">Tap to browse the web page.</td> </tr> </table>	Next Key	Tap to go to the next field.	Done Key	Tap to confirm the settings.	Send Key	Tap to dial out the number.	Go Key	Tap to browse the web page.
Next Key	Tap to go to the next field.									
Done Key	Tap to confirm the settings.									
Send Key	Tap to dial out the number.									
Go Key	Tap to browse the web page.									
4		Tap to switch to the uppercase input mode.								
5		Tap to switch to the numeric&symbolic input mode.								
6	Five Special Characters	Tap to enter the special character.								
7	Space Key	<ul style="list-style-type: none"> • Tap to enter spaces. • Long tap to change the input method. 								

No.	Item	Description
		Tip: You can also tap  at the bottom right corner of the phone screen to change the input method.
8		Tap to access input options to configure Input languages or Android Keyboard Settings (AOSP) . You can use AOSP to configure Android keyboard including Input languages, Auto-capitalization, Sound on keypress and so on.

Tap  to switch to the numeric&symbolic input mode.



No.	Item	Description	
1	Numbers	<ul style="list-style-type: none"> • Tap to enter numbers. • Long tap a key then slide to choose one of the options to enter an alternate character. 	
2	Delete Key	<ul style="list-style-type: none"> • Tap to delete the entered characters one by one. • Long tap to delete two or more characters. 	
3	Label automatically to identify the context-sensitive features.	Next Key	Tap to go to the next field.
		Done Key	Tap to confirm the settings.
		Send Key	Tap to dial out the number.
		Go Key	Tap to browse the web page.
4		Tap to switch to the symbolic input mode.	
5		Tap to switch to the lowercase input mode.	
6	Space Key	<ul style="list-style-type: none"> • Tap to enter spaces. • Long tap to change the input method. <p>Tip: You can also tap  at the bottom right corner of the phone screen to change the input method.</p>	
7	Special Characters	<ul style="list-style-type: none"> • Tap to enter special characters. • Long tap a key, then slide to choose one of the options to enter an alternate character. 	

Tap  to switch to the symbolic input mode.

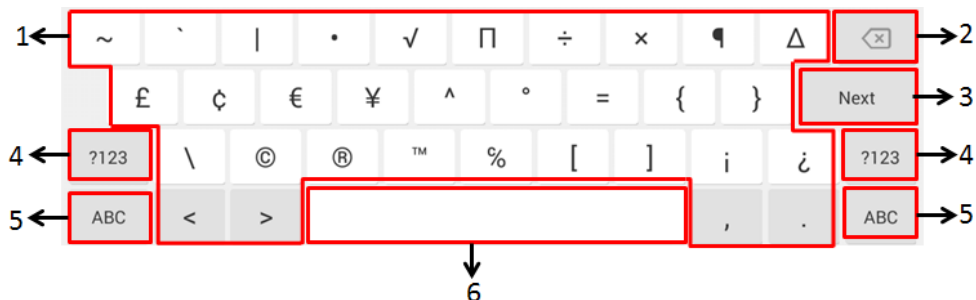

No.	Item	Description	
1	Special Characters	<ul style="list-style-type: none"> Tap to enter special characters. Long tap a key then slide to choose one of the options to enter an alternate character. 	
2	Delete Key	<ul style="list-style-type: none"> Tap to delete the entered characters one by one. Long tap to delete two or more characters. 	
3	Label automatically to identify the context-sensitive features.	Next Key	Tap to go to the next field.
		Done Key	Tap to confirm the settings.
		Send Key	Tap to dial out the number.
		Go Key	Tap to browse the web page.
4	?123	Tap to switch to the numeric&symbolic input mode.	
5	ABC	Tap to switch to the lowercase input mode.	
6	Space Key	<ul style="list-style-type: none"> Tap to enter spaces. Long tap to change the input method. <p>Tip: You can also tap  at the bottom right corner of the phone screen to change the input method.</p>	

Google Pinyin Input Method

You can use Google Pinyin input method (谷歌拼音输入法) to enter Chinese characters.

When you change the input method to Google Pinyin, the onscreen keyboard displays the English input mode as shown below by default:

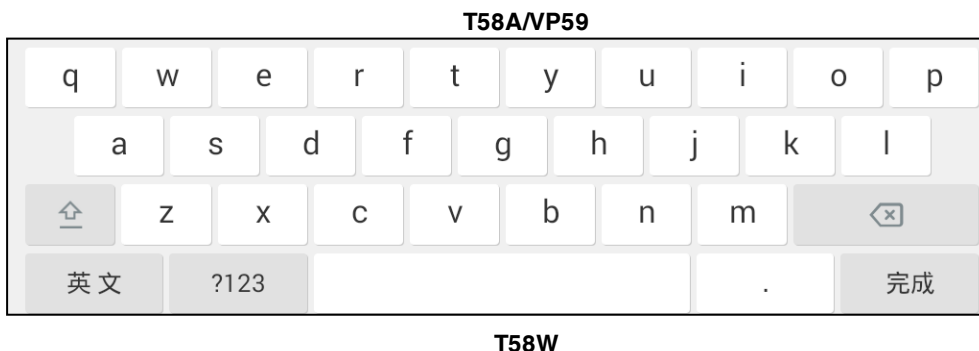



Tap **英文** (for T58W, long tap ) to switch to the Chinese input mode as shown below:

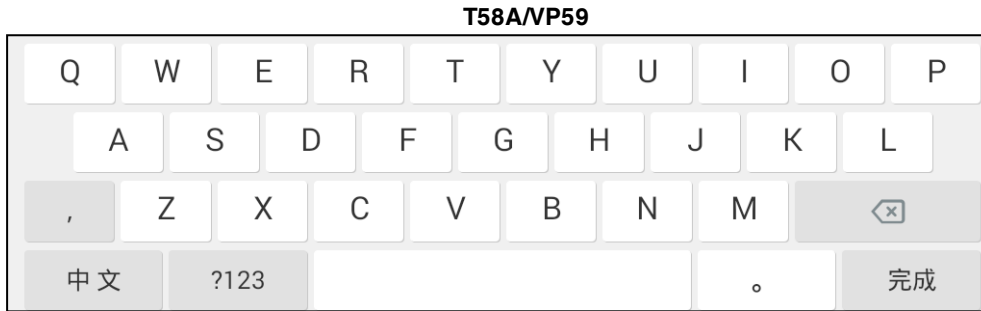

Tap **?123** to switch to the numeric&symbolic input mode as shown below:



Tap **ALT / #+=** to switch to the symbolic input mode as shown below:

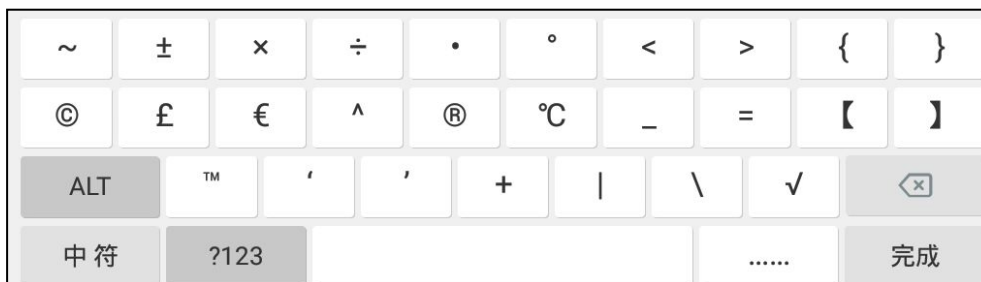

Related Topic[Changing the Input Method](#)**Using the Phone Keypad and Dial Pad**

You can use the keypad on your phone or dial pad to enter data. The dial pad only provides digit keys, # key, and * key.

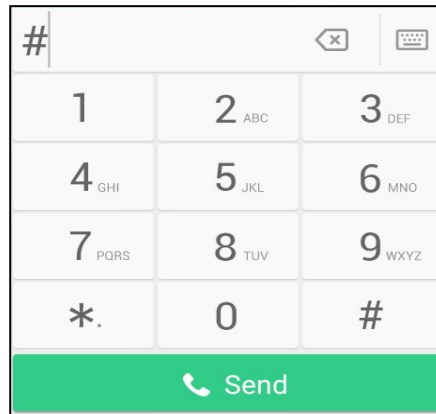

You can tap  () to switch to the onscreen keyboard.

Related Topic[Using the Onscreen Keyboard](#)

Call Features

You can use the phone to place and answer calls, ignore incoming calls, transfer a call to someone else, conduct a conference call and perform other basic call features.

Topics

- [Changing the Default Account](#)
- [Placing Calls](#)
- [Answering Calls](#)
- [Switching Among the Handset, Speakerphone and Headset Modes](#)
- [Audio-only/Video Call Selection](#)
- [Switching Between Calls Screen and Idle Screen](#)
- [Options during a Video Call](#)
- [Capturing a Screenshot](#)
- [Disabling Call Waiting](#)
- [Silencing or Rejecting Incoming Calls](#)
- [Ending Calls](#)
- [Redialing a Call Automatically](#)
- [Muting/Unmuting Audio](#)
- [Keep Mute](#)
- [Holding and Resuming Calls](#)
- [Redirecting Incoming Calls](#)
- [Transferring Calls](#)
- [Conference Calls](#)
- [Call Recording](#)
- [Multicast Paging](#)
- [Sharing Content during a Call](#)

Changing the Default Account

If there are multiple registered accounts on the phone, you can place a call with the default account by default.

Procedure

1. Tap the label of the default account at the top left, and then tap the desired account to be the new default account.

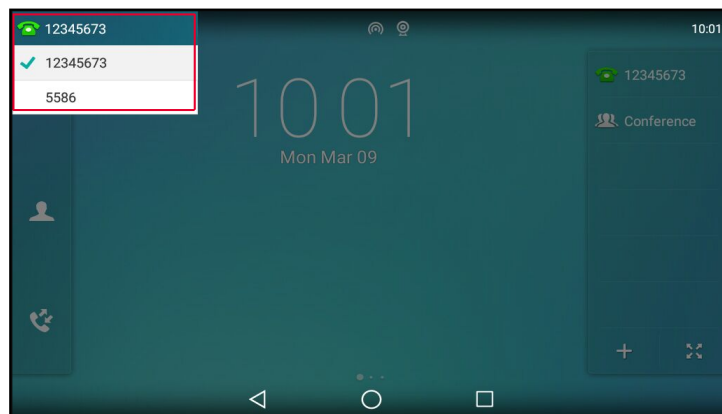

Placing Calls

You can use your phone like a regular phone to place calls in many ways easily.

Topics

- [Placing a Call from the Dialer](#)
- [Placing Multiple Calls](#)
- [Placing a Call with a Speed Dial Key](#)
- [Placing a Call Back to the Last Incoming Number](#)
- [Redialing a Number](#)
- [Dialing a Hotline Number](#)
- [Placing an International Call](#)
- [Placing a Call from the Call History](#)
- [Placing a Call from the Directory](#)
- [Placing an Anonymous Call](#)
- [Placing a Call from the Google Contacts](#)



Placing a Call from the Dialer

The Dialer enables you to enter a number to place a call, and it displays a list of previously placed calls or contacts in your directory.

You can also select the desired contact from the search list, the placed call list or Directory.

Note: Your system administrator can configure the source list for searching and disable to display the placed call records.

Procedure

1. Do one of the following:
 - Start typing a phone number.
 - Tap the desired line key.
 - Pick up the handset, press the Speakerphone key or the HEADSET key  .
2. Enter a number.
3. Select **Send** .

Note: Your system administrator can enable live dialpad feature, which enables your phone to automatically dial out the phone number after a period of time without selecting **Send**.



Related Topic

[Switching Among the Handset, Speakerphone and Headset Modes](#)

Placing Multiple Calls

When you are in a call, you can hold your current call and place a new call.



Procedure

1. Do one of the following:
 - Select a line key. The active call is placed on hold.
 - Press the HOLD key  or select **Hold** to place the original call on hold.
Select **New Call**.
2. Enter the desired number or select a contact.
3. Select **Send** .

Placing a Call with a Speed Dial Key

You can quickly dial a number by using a Speed Dial key.

Procedure

1. Swipe left or right to go to the second idle screen.
2. Go to **Settings > Features > Dsskey**.
3. Select the desired line key.
4. Select **SpeedDial** from the **Type** field.
5. Select the desired line from the **Account ID** field.
6. Do one of the following:
 - (Optional.) Enter the string that will appear on the phone screen in the **Label** field.
Enter the contact number you want to dial out directly in the **Value** field.
You can also enter the contact number with the DTMF sequence that you want to send in the **Value** field. The contact number and DTMF sequence are separated by commas. One comma stands for 500 milliseconds.
For example, **1234,,123#** means the phone dials out the number 1234 first, then after the call is set up for 1 second, it sends the DTMF sequence 123# to the remote party.
 - Select  and select the desired contact.
7. Select .

Tip: By default, you can drag the line key to the **Edit** field to set it.

When the phone is idle, you can tap the Speed Dial key to call a contact quickly. The phone calls a contact using the configured line by default. If you want to call a contact using another line, you can first tap the line key, and then tap the Speed Dial key.

Placing a Call Back to the Last Incoming Number

You can redial the last incoming number quickly by using a Recall key.

Procedure

1. Swipe left or right to go to the second idle screen.
2. Go to **Settings > Features > Dsskey**.
3. Select the desired line key.
4. Select **Key Event** from the **Type** field.
5. Select **Recall** from the **Key Type** field.
6. (Optional.) Enter the string that will appear on the phone screen in the **Label** field.
7. Select .

Tip: By default, you can drag the line key to the **Edit** field to set it.

When the phone is idle, tap the Recall key to quickly redial the last incoming number.

Redialing a Number

The phone keeps a record of all the placed calls. You can recall the contact you recently called.

Procedure



1. Press the REDIAL key .
The phone screen displays the placed calls list.
2. Tap the desired record.

Tip: Press the REDIAL key  twice to recall the contact you called.

Dialing a Hotline Number

When the phone is off-hook, it will dial out the hotline number automatically after the designated delay time.

Procedure

1. Swipe left or right to go to the second idle screen.
2. Go to **Settings > Features > Hot Line**.
3. Do one of the following:
 - Enter the desired number in the **Number** field.
 - Select  and select the desired contact.
4. Enter the desired delay time (0-10 seconds) in the **Hotline Delay** field.
5. Select .

Placing an International Call

You can place calls to international phone numbers on your phone.



Procedure

1. Long press digit key 0 on the phone keypad until the **plus sign (+)** appears.
2. Enter the phone number with the country code.
3. Select **Send** ().

Placing a Call from the Call History

You can place calls to contacts from the History list, which contains the calls that were recently placed, answered, missed, or forwarded.



Procedure

1. Tap  ().
The phone screen displays all call records.
2. Select the desired call list.
3. Tap the desired entry.

Placing a Call from the Directory

You can place a call to a contact directly from your directory.

Procedure

1. Tap  ().
2. If the contact was added to a specified contact group, you can select the desired contact group.
3. Tap the desired contact or tap .
If the selected contact has multiple numbers, tap the desired number to dial out.

Related Topic

[Searching for Contacts](#)

Placing an Anonymous Call

You can hide your name and number when you place a call. As a result, the callee receives an anonymous call without caller identity.

Before You Begin

Contact your system administrator to find out if this feature is available on your phone, and to get the anonymous call on code or off code if required.

Procedure

1. Swipe left or right to go to the second idle screen.
2. Go to **Settings > Features > Anonymous**.
3. Select the desired line.
4. Turn on **Local Anonymous**.
5. (Optional.) Select **On Code** or **Off Code** from the **Send Anonymous Code** field.
6. (Optional.) Enter the anonymous call on code and off code respectively.
7. Select .
8. Select the anonymous line to place a call.

The callee is prompted with an incoming call from anonymity.

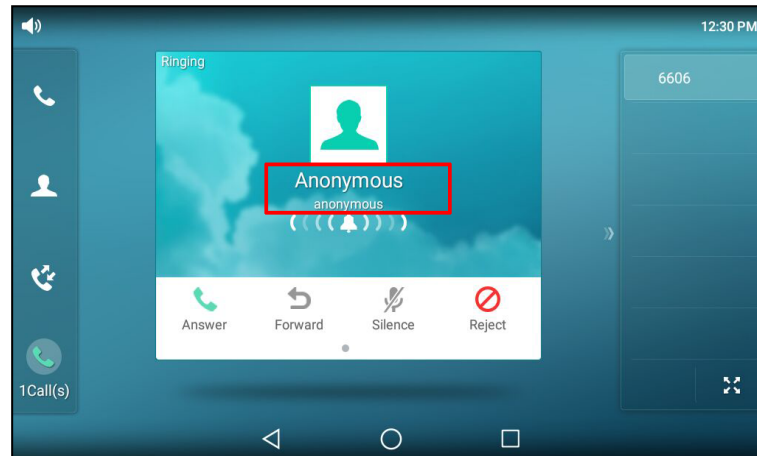

If the callee enables anonymous rejection feature, you may be prompted that the callee does not accept calls from an anonymous number.

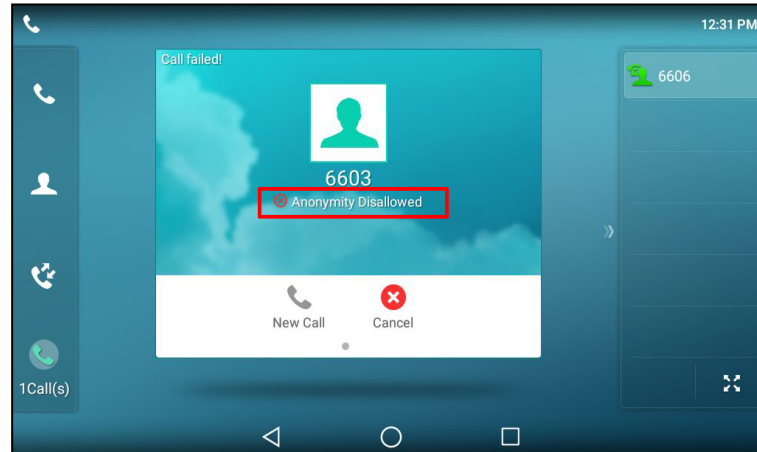

Tip: You can select **All On** to turn on local anonymous for all lines.

Related Topic

[Rejecting Anonymous Calls](#)



Placing a Call from the Google Contacts

You can place calls to the contact from the Google Contacts list.

Before You Begin

Make sure the Google Contacts feature is enabled.

Procedure

1. Go to  () > **Google Contacts**.
2. Tap the desired contact or tap .
If the selected contact has multiple numbers, tap the desired number.

Related Topics

[Enabling the Google Contacts Feature](#)
[Searching for Google Contacts](#)

Answering Calls

When you receive a call, you can choose to answer it manually or automatically.



Topics

[Answering a Call](#)
[Answering a Call When in a Call](#)
[Answering a Call Automatically](#)

Answering a Call

When you receive an incoming call, the phone rings and the screen displays the information of the incoming call. You can choose to answer the incoming call.

Procedure

1. Do one of the following:
 - Pick up the handset.
 - Press the Speakerphone key .
 - Press the HEADSET key  (.
 - Tap **Answer** or the line key.

The call is answered in the speakerphone (hands-free) mode by default.

Related Topic

[Switching Among the Handset, Speakerphone and Headset Modes](#)

Answering a Call When in a Call

You can answer a call when there is already an active call on your phone.

When you are in an active call and an incoming call arrives on the phone, a call waiting tone beeps, and the incoming call information is displayed.

Procedure

1. Select **Answer**.

The active call is placed on hold, and the incoming call becomes active.

Note: You can disable the call waiting feature to reject the incoming call automatically during a call.

Related Topic

[Disabling Call Waiting](#)

Answering a Call Automatically

Auto answer enables you to automatically answer an incoming call in speakerphone (hands-free) mode when your phone is idle.

Procedure

1. Swipe left or right to go to the second idle screen.
2. Go to **Settings > Features > Auto Answer**.
3. Turn on **Auto Answer** for the desired line.
4. Select .

If the auto answer feature is enabled for the default account, the auto answer icon appears on the phone screen.

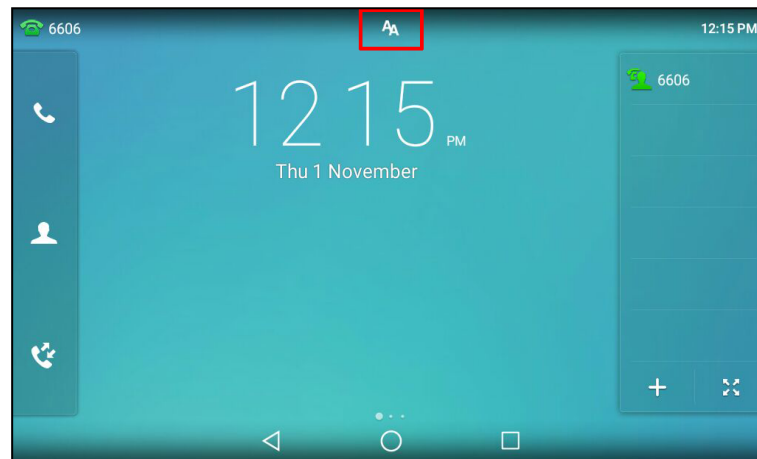

Tip: You can also swipe down from the top of the screen to enter the control center, tap **Auto Answer** to enter **Auto Answer** setting screen, and then enable auto answer feature for the desired line.

Disabling Call Waiting

If the call waiting feature is disabled, when there is already a call, the new incoming call will be rejected automatically.

Before You Begin

Check with your system administrator if the call waiting off code is required. If required, get it from your system administrator.





Procedure

1. Swipe left or right to go to the second idle screen.
2. Go to **Settings > Features > Call Waiting**.
3. Turn off **Call Waiting**.
4. (Optional.) Enter the call waiting off code in the **Off Code** field.
5. Select .

Switching Among the Handset, Speakerphone and Headset Modes

You can select the desired mode before placing a call or can alternate among Speakerphone, headset, and handset modes during a call.

Procedure

- During the call, pick up the handset, press the Speakerphone key , or press the HEADSET key   .
For example, if you're using the handset, press the HEADSET key   to switch to the headset, or press the Speakerphone key to switch to the speakerphone.

Note: Your system administrator can disable you to use the handset, speakerphone (Hands-free) or headset mode.

Audio-only/Video Call Selection

You can choose to establish an audio-only call or video call while dialing or ringing, or toggle between an audio-only call and video call. This feature should be pre-configured by your system administrator.

Topics

[Placing an Audio-only/Video Call](#)

[Answering a Video Call](#)

[Switching between Video Call and Audio-only Call](#)

Placing an Audio-only/Video Call

You can choose to initiate an audio-only call or a video call.

Procedure

- When the phone is idle, do one of the following:
 - Enter the desired number.
 - Tap the line key and enter the desired number.

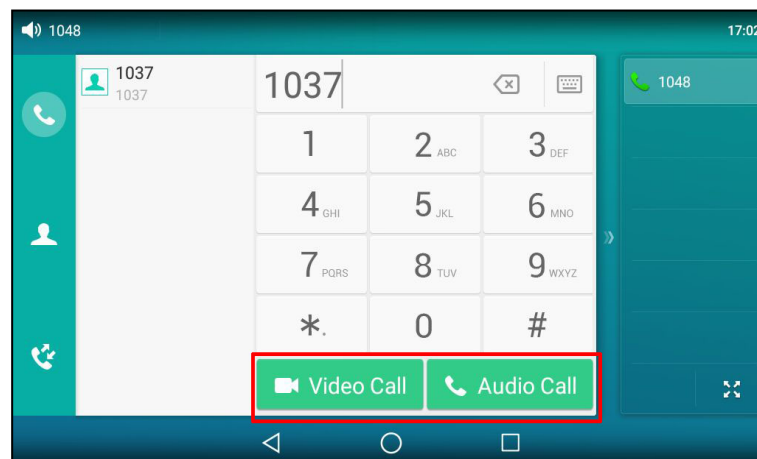

- Tap **Video Call**  / **Audio Call**  to place a video call or audio-only call.

Answering a Video Call

When an incoming video call arrives, you can choose to answer the call with audio-only or video.

Procedure

When an incoming call arrives, the phone screen is shown below:

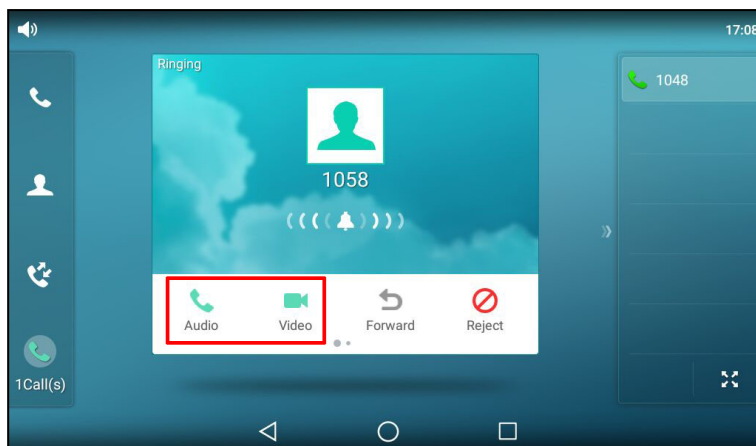

1. Tap **Audio** or **Video** to establish an audio-only call or video call.

Switching between Video Call and Audio-only Call

Your system administrator can make you have the option to switch between a video call and an audio-only call during the active call.

Note: You cannot switch between a video call and audio-only call during a three-way conference, or while the call is placed on hold.

Topics

- [Switching to the Audio-only Call](#)
- [Initiating a Video Call](#)

Switching to the Audio-only Call

During the video call, you can switch to the audio-only call quickly.

Procedure

1. During an active video call, tap  if required (for T58W, tap the screen).
 2. Tap **Audio Only**.
- The audio-only call is automatically established.*

Initiating a Video Call

During the audio-only call, you can initiate a video call.

Procedure

1. During an audio-only call, tap **Add Video**.
- By default, the video call is automatically established with the other party that is video-enabled.*
- If the other party can only establish an audio-only call, the phone prompts "The other end is not available".*

Related Topic

- [Switching to the Audio-only Call](#)

Switching Between Calls Screen and Idle Screen

During the call, you can access other applications to confirm some issues. After the operation, you can return to the call conveniently.

Topics

- [Going Back to the Idle Screen during a Call](#)

[Returning to the Talking Screen](#)

Going Back to the Idle Screen during a Call

During the call, you can go back to the idle screen to access other applications.

Procedure

1. Tap ,  or  to go back to the idle screen.

For T58W, tap **More > Home Page**.

Returning to the Talking Screen

After going back to the idle screen, you can return to the talking screen as long as the call is not ended.

Procedure

Do one of the following when you are in the idle screen:

- Tap .
- Tap **Back To Talking** on the top of the phone screen.
- Tap the floating video window.

Options during a Video Call

During a video call, you can easily do some operations to make the call more personalized.

Topics

[Stopping Transmitting Video during a Call](#)

[Changing the Video Layout during a Call](#)

[Previewing the Near-Site Video](#)

Stopping Transmitting Video during a Call

When you do not want the phone to transmit your video during a video call, you can stop it.

Procedure

1. Do one of the following:
 - Unplug the camera.
 - Swipe down from the top of the screen in the video call screen and then tap **Video**.

Your phone will not transmit video to your contact and the far site cannot see you.

Note: Stopping transmitting video does not create an audio-only call. Even if you stop transmitting video, you can see the other party, and the call is still a video call. To place an audio-only call, contact your system administrator.

Changing the Video Layout during a Call

During video calls, near-site and far-site video images are displayed on the phone screen. You can change the video layout.

The T58A/VP59 phone supports two video layouts:

- **One large, other small:** One video image is displayed in a large size, the other video images along the right side of the screen are displayed in small sizes.
- **Full screen:** One video image is displayed in full size, the other video images are hidden.

Topics

[Swapping Video](#)

[Changing the Video Layout to the Full Screen Mode](#)

Hiding the Local Video Window

Swapping Video

During a video call, you can switch the locations of near-site video and far-site video.

Procedure

1. Tap the small video window during a video call.

Changing the Video Layout to the Full Screen Mode

You can change the video layout from “one large, other small” to the full screen mode.

Procedure

1. Do one of the following:
 - Tap the large window.
 - Pinch open the large window.

The small window is hidden, and the following figure shows what the phone screen looks like in full screen mode:

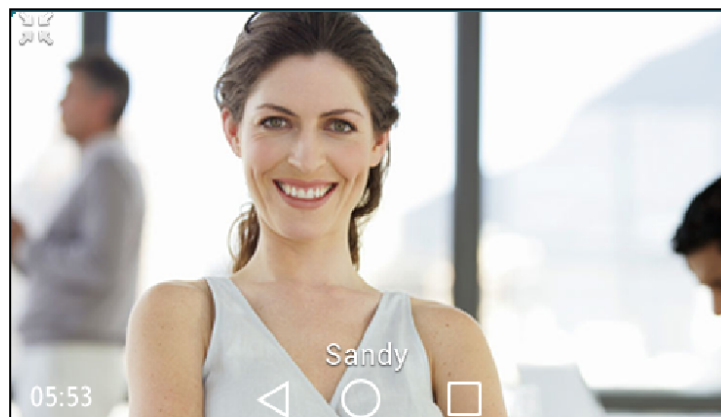

Hiding the Local Video Window

You can hide the local video window during a two-way video conversation.



Procedure

1. Tap .

Previewing the Near-Site Video

If you have connected the camera to the phone, you can preview the video of yourself that will be displayed during video calls. During the preview, you can configure camera settings.

Procedure

- Swipe down from the top of the screen and then tap **Video**.
- Swipe left or right to go to the second idle screen and tap  () to launch **Camera**.
- On VP59, press .

Related Topic

[Camera Settings](#)

Capturing a Screenshot

You can capture a screenshot when the phone is idle or during a call.

The screenshots are saved in ".png" format in the internal SD card with the name consisting of a prefix "Screenshot" and date & time stamp. You can view the screenshots by [File Manager](#) or [Gallery](#).

Tip: You can view the screenshots on either the phone itself or on a computer using an application capable of viewing ".png" files.

Topics

[Capturing a Screenshot When the Phone is Idle](#)

[Capturing a Screenshot during a Call](#)

[Viewing the Latest Screenshot](#)

Capturing a Screenshot When the Phone is Idle

You can capture the screenshot when the phone is idle for saving the favorite picture or picture needed.

Procedure

1. Swipe down from the top of the screen.
2. Tap **Screenshot**.

If the screenshot is successfully saved, a notification displays in the notification center.



If there is no enough space in internal SD card, you cannot save the screenshot, and the notification center will display a notification "Couldn't capture screenshot."

Capturing a Screenshot during a Call

You can capture the screenshot during a call for saving the favorite picture or picture needed.

It is not available to T58W phones.

Procedure

1. Do one of the following:
 - Press the MESSAGE Key  ().
 - Swipe down from the top of the screen.
Tap **Screenshot**.

If the screenshot is successfully saved, a notification displays in the notification center.

If there is no enough space in internal SD card, you cannot save the screenshot, and the notification center will display a notification "Couldn't capture screenshot."

Viewing the Latest Screenshot

If multiple screenshots are successfully saved, you can view the latest screenshot via the notification center.

Procedure

1. Swipe down from the top of the screen.
2. Tap the notification "Screenshot captured."

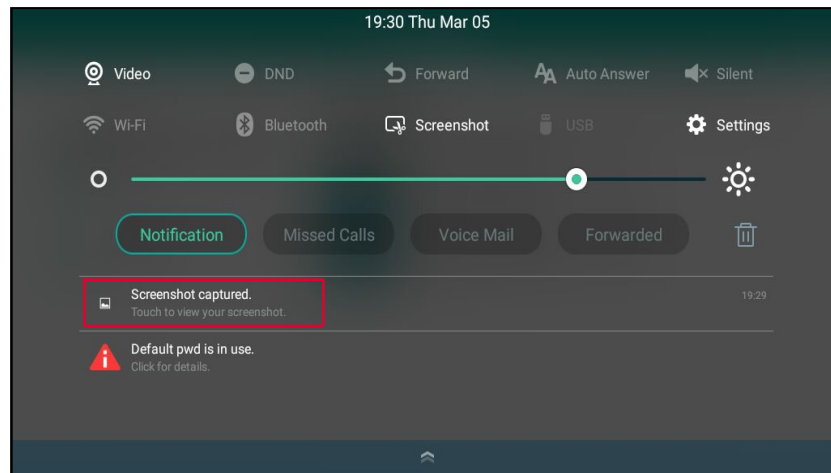

Silencing or Rejecting Incoming Calls

When you receive an incoming call, you can choose to silence or reject the call instead of answering.

Topics

- [Silencing a Call](#)
- [Rejecting a Call Manually](#)
- [Rejecting Anonymous Calls](#)
- [Rejecting Calls with Do Not Disturb \(DND\)](#)

Silencing a Call

You can silence a call to stop your phone from ringing. Even if you silence the call, the incoming call notification continues to be displayed on your phone.

Procedure

1. Select **Silence**.

Rejecting a Call Manually

You can reject a call manually, and the call may be sent to voice mail. The rejected calls are displayed in the Received Calls list in your History list.

Procedure

1. Select **Reject**.

Rejecting Anonymous Calls

You can reject incoming calls from the callers who have hidden their identities. As a result, your phone will not ring and you will not be notified of an attempted call.

Before You Begin

Check with your system administrator if the anonymous call rejection on code or off code is required. If required, get it from your system administrator.

Procedure

1. Swipe left or right to go to the second idle screen.
2. Go to **Settings > Features > Anonymous**.
3. Select the desired line.
4. Turn on **Local Anonymous Rejection (Anonymous Rejection)**.

5. (Optional.) Select **On Code** or **Off Code** in the **Send Anonymous Rejection Code** field.
6. Enter the anonymous call rejection on code and off code respectively in the **On Code** and **Off Code** field beneath the **Send Anonymous Rejection Code** field.
7. Select .

Related Topic

[Placing an Anonymous Call](#)

Rejecting Calls with Do Not Disturb (DND)

You can enable DND to reject all incoming calls automatically when you do not want to be interrupted.

If you want to receive incoming calls from the specific numbers when DND is enabled, you can ask your system administrator to set DND Authorized Numbers.

Note: Check with your system administrator to find out if the DND feature is available on your phone.

Topics

[Rejecting Calls with DND on All Lines](#)

[Rejecting Calls with DND on a Specific Line](#)

[Deactivating DND](#)

Rejecting Calls with DND on All Lines

If there are multiple lines on the phone, you can enable DND for all lines. After activating it, the phone will reject all incoming calls automatically.

Note: If both DND and busy forward are activated on the phone, calls will be forwarded to the configured destination number.

Before You Begin

Check with your system administrator if the DND on code or off code is required. If required, get it from your system administrator.

Procedure

1. Do one of the following:
 - Swipe down from the top of the screen and toggle **DND** on.
 - Swipe left or right to go to the second idle screen, and then go to **Settings > Features > DND**. Turn on DND.
2. (Optional.) Enter the DND on code or off code respectively in the **On Code** or **Off Code** field.
3. Tap .

The DND icon appears in the status bar. And the phone prompts you that DND is enabled.

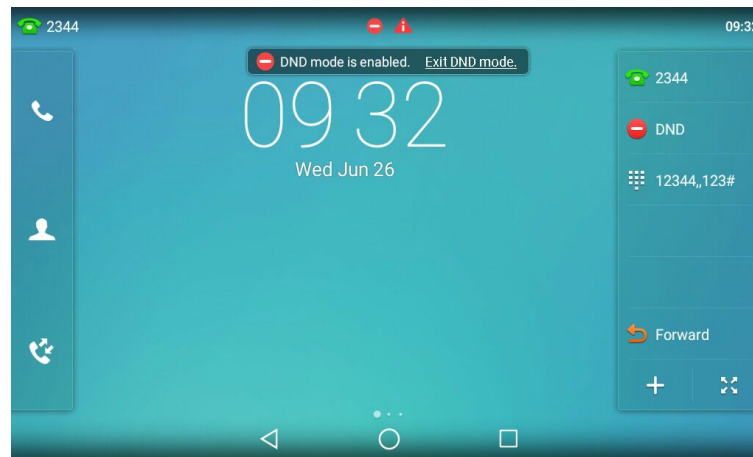

Rejecting Calls with DND on a Specific Line

By default, the DND feature applies to all lines on your phone. Your system administrator can change the DND mode to Custom so that you can enable DND for specific lines.

Before You Begin

The DND mode is set to **Custom**. Check with your system administrator if the DND on code or off code is required. If required, get it from your system administrator.

Procedure

1. Do one of the following:
 - Swipe down from the top of the screen and tap **DND**.
 - Swipe left or right to go to the second idle screen, and then go to **Settings > Features > DND**.
2. Select the desired line.
3. Turn on DND.
4. (Optional.) Enter the DND on code or off code respectively in the **On Code** or **Off Code** field.
5. Tap ✓.

The DND icon appears on the desired line.

If you activate DND on the default line, the DND icon will appear both on the line and in the status bar. And the phone prompts you that DND is enabled.

Tip: Before selecting a line, you can tap  > **All On** to activate DND for all lines.

Deactivating DND

You can deactivate DND when you are ready to resume receiving calls again.

Procedure

1. Swipe left or right to go to the second idle screen.
2. Go to **Settings > Features > DND**.
3. (Optional.) If the DND is activated on a specific line, select the desired line.
4. Turn off DND.
5. Tap ✓.

The DND icon disappears from the status bar.

Tip: To deactivate DND quickly, tap the **Exit DND mode** when the phone is idle. You can also swipe down from the top of the screen to enter the control center and then tap **DND** to deactivate DND.

You can tap  > **All Off** at the top right to deactivate DND for all lines.

Ending Calls

You can end the current call at any time.

Procedure

1. Do one of the following:
 - If you are using the handset, select **End Call** or hang up the handset.
 - If you are using the headset, select **End Call**.
 - If you are using the speakerphone, press the Speakerphone key  or select **End Call**.

Redialing a Call Automatically

You can set the phone to redial a phone number automatically when you call a contact and the contact's line is unavailable.

Procedure

1. Swipe left or right to go to the second idle screen.
2. Go to **Settings > Features > Auto Redial**.
3. Turn on **Auto Redial**.
4. Enter the desired time (between 1 and 300 seconds) in the **Redial Interval** field.
5. Enter the desired times (between 1 and 300) in the **Redial Times** field.
6. Select .

When you dial a number but fail to establish a call, the phone prompts the failure reason and then prompts whether to auto redial the contact, select **OK** to activate auto redial.

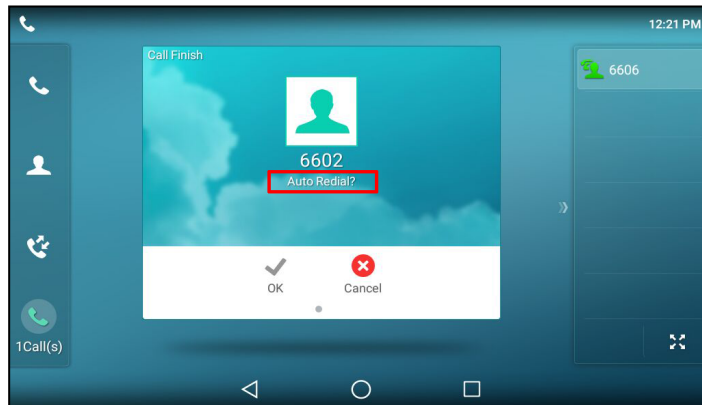

The phone screen displays the redial times and interval. The phone will retry as many times as configured until the callee answers the call.

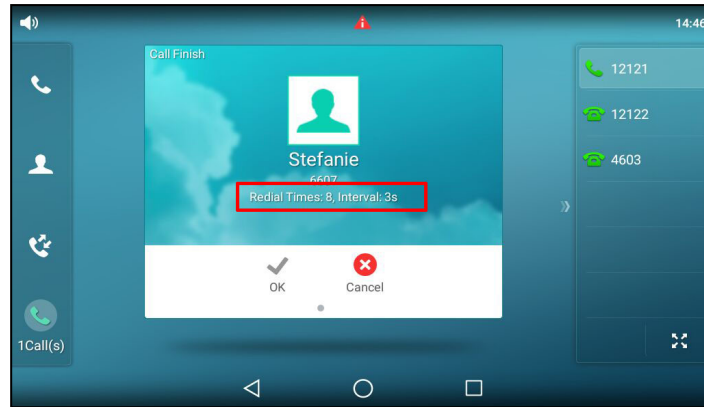

Muting/Unmuting Audio

When you are in a call, you can mute the audio, so that you can hear the other person, but they cannot hear you.

Procedure

1. Press the MUTE key   during a call.
The mute key LED glows red.
2. Press the MUTE key   again to unmute the call.
The mute key LED goes out.

Keep Mute



In a meeting room, if incoming calls are answered automatically on your phone, callers may hear your discussion with your colleagues. You can keep the phone in mute to prevent this unintended situation.

The mute state of your phone persists across calls. The phone stays in the mute state until you unmute the microphone manually or until the phone restarts.

Before You Begin

Check with your system administrator if keep mute is configured on your phone.

Procedure

1. Press the MUTE key   when the phone is idle.
The mute key LED glows red, and the mute icon appears on the idle screen.

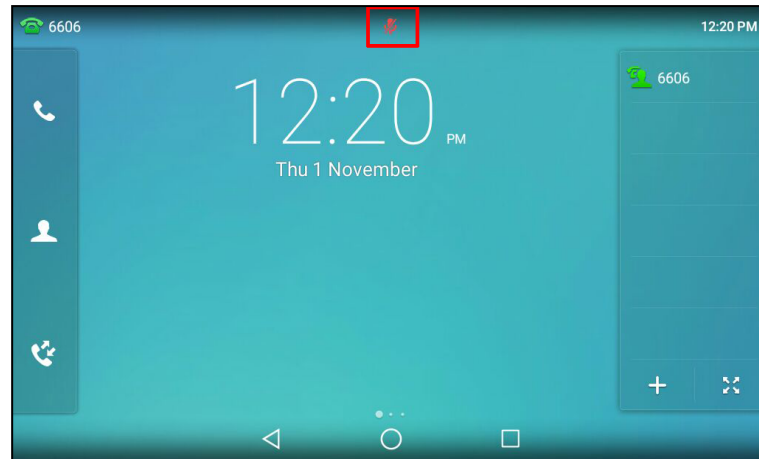

2. Press the MUTE key  () again to deactivate the mute state.

Holding and Resuming Calls

You can place an active call on hold and resume the call when you are ready. When you place a call on hold, the held party may hear the music played by its sever.

Topics

[Holding a Call](#)

[Resuming a Held Call](#)

Holding a Call

You can place an active call on hold on your phone.

Procedure

1. Press the HOLD key  or select **Hold** during a call.

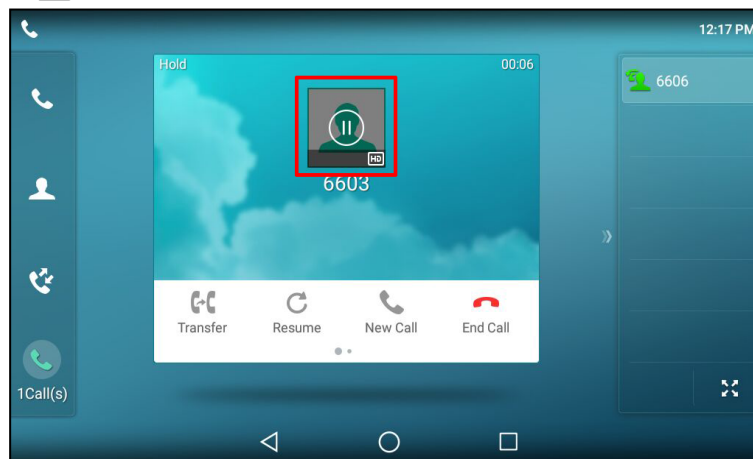

Note: When you have multiple calls on the phone and the current call is held, you can tap the call directly to swap to the active call.

Resuming a Held Call

You can view and resume a held call on the phone.

Procedure

1. Press the HOLD key  or select **Resume**.

If multiple calls are placed on hold, select the desired call first.

Note: When you have multiple calls on the phone and the current call is active, you can tap the call directly to swap to the held call.

Redirecting Incoming Calls

When you are not available to answer calls on your phone, you can forward the calls to another phone.

Topics

[Forwarding All Incoming Calls to a Contact](#)
[Forwarding an Incoming Call Manually](#)
[Forwarding Incoming Calls with a Forward Key](#)
[Diverting Calls to a Contact](#)

Forwarding All Incoming Calls to a Contact

You can set up the forwarding type which enables your phone to forward all incoming calls to a contact.

There are three types of forwarding:

- **Always Forward:** Forwards all incoming calls immediately.
- **Busy Forward:** Forwards incoming calls when you are busy in a call.
- **No Answer Forward:** Forwards incoming calls when no one answers the calls.

Topics

[Forwarding All Incoming Calls on All Lines](#)
[Forwarding All Incoming Calls on a Specific Line](#)
[Deactivating Call Forward](#)



Forwarding All Incoming Calls on All Lines

You can forward all incoming calls on the phone.

Before You Begin

Check with your system administrator if the forward on code or off code is required. If required, get it from your system administrator.

Procedure

1. Swipe left or right to go to the second idle screen.
2. Go to **Settings > Features > Call Forward**.
3. Select the desired forwarding type and turn on the feature.
4. Do one of the following:
 - Enter the contact number you want to forward incoming calls to in the **Forward to** field.
 - Select  and select the desired contact.
5. If you select the **No Answer Forward** option, select the desired ring time to wait before forwarding from the **After Ring Time** field.
6. (Optional.) Enter the always/busy/no answer forward on code or off code respectively in the **On Code** or **Off Code** field.
7. Tap .

The call forward icon appears in the status bar. And the phone prompts you that call forward is enabled.

Tip: You can also swipe down from the top of the screen to enter the control center, tap **Forward** to enter the desired Call Forward setting screen according to the current forward type.

If you have not configured the call forward type, tapping **Forward** will turn to the Always Forward setting screen.



Forwarding All Incoming Calls on a Specific Line

By default, the forwarding setting applies to all lines on your phone. Your system administrator can change the forward mode to Custom so that you can forward all incoming calls for specific lines.

Before You Begin

Check with your system administrator if the forward on code or off code is required. If required, get the forward on code or off code from your system administrator.

Procedure

1. Swipe left or right to go to the second idle screen.
2. Go to **Settings > Features > Call Forward**.
3. Select the desired line.
4. Select the desired forwarding type and turn on the feature.
5. Do one of the following:
 - Enter the contact number you want to forward incoming calls to in the **Forward to** field.
 - Select  and select the desired contact.
6. If you select the **No Answer Forward** option, select the desired ring time to wait before forwarding from the **After Ring Time** field.
7. (Optional.) Enter the always/busy/no answer forward on code or off code respectively in the **On Code** or **Off Code** field.
8. Tap .

The forward icon appears on the desired line.

If you activate forward on the default line, the forward icon will appear both on the line and in the status bar. And the phone prompts you that call forward is enabled.

Tip: You can tap  > **All Lines** to activate forward for all lines.

Deactivating Call Forward

You can deactivate the call forward when you no longer want to forward your calls.

Procedure

1. Swipe left or right to go to the second idle screen.
2. Go to **Settings > Features > Call Forward**.
3. (Optional.) If the forward is activated for a specific line, select the desired line.
4. Select the desired forwarding type and turn off the feature.
5. Tap .

Tip: You can tap  > **All Lines** to deactivate forward for all lines. You can also tap **Close forward**. to deactivate forward for all lines.

Forwarding an Incoming Call Manually

You can manually forward the call to another contact while your phone rings.

Procedure

1. When the phone is ringing, select **Forward**.
2. Enter the number you want to forward the incoming call to.



3. Select **Forward** ().

The phone prompts a call forward message.

Forwarding Incoming Calls with a Forward Key

When the phone receives an incoming call, you can easily tap the Forward key to forward the incoming call to a specific contact.

Procedure

1. Swipe left or right to go to the second idle screen.
2. Go to **Settings > Features > Dsskey**.
3. Select the desired line key.
4. Select **Key Event** from the **Type** field.
5. Select **Forward** from the **Key Type** field.
6. If your system administrator has set the forward mode to **Custom**, select the desired line.
7. Do one of the following:
 - (Optional.) Enter the string that will display on the phone screen in the **Label** field.
Enter the contact number you want to forward the incoming calls to in the **Value** field.
 - Select  and select the desired contact.
8. Select .





Tip: By default, you can drag the line key to the **Edit** field to set it.

When the phone is ringing, tap the forward key to quickly forward the call to the specific contact.

Diverting Calls to a Contact

You can divert all incoming calls from a particular contact to another contact. Auto divert has precedence over call forward.

Procedure

1. Select  (.
2. Tap  after the desired contact.
For T58W, tap the desired contact and select .
3. Edit the contact information.
4. Enter a contact's number you want to divert the call to in the **Auto Divert** field.
5. Select  or **OK**.

Transferring Calls

During a call, you can transfer the call to another contact.

You can use one of three ways:

- **Blind Transfer:** Transfer a call directly to the third party without consulting.
- **Semi-Attended Transfer:** Transfer a call when receiving ringback.
- **Attended Transfer (Consultative Transfer):** Transfer a call with prior consulting.

Topics

[Performing a Blind Transfer](#)

[Performing a Semi-Attended/Attended Transfer](#)

Performing Transfer with a Transfer Key

Performing a Blind Transfer

You can transfer a call to another contact immediately without consulting with her/him first.

Topics



[Performing a Blind Transfer Normally](#)

[Performing a Blind Transfer Conveniently](#)

Performing a Blind Transfer Normally

You can enter the number, or select a contact from directory or history to perform a blind transfer.



Procedure

1. Press the TRANSFER key  or select **Transfer** during a call.
2. Do one of the following:
 - Enter the number you want to transfer the call to, and press the TRANSFER key  or select **Transfer** .

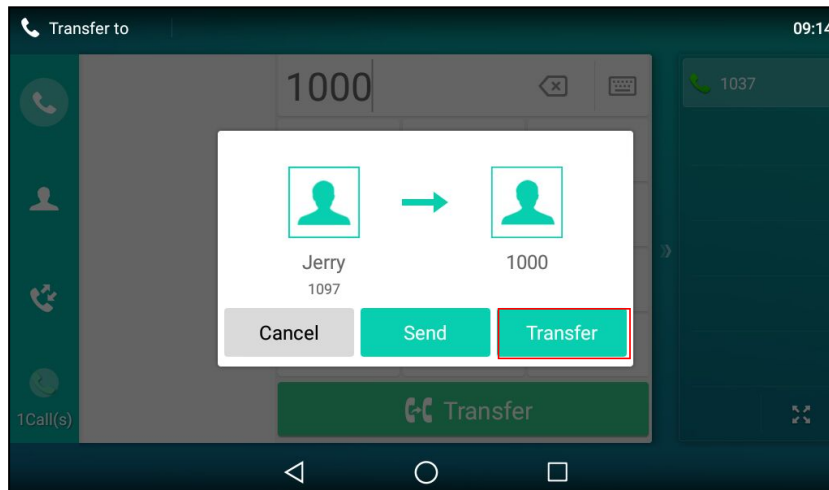
For T58A/VP59, the phone will prompt a dialog box as the following shows:



Select **Transfer** to complete the transfer. (The call will automatically dial out in about 5 seconds if you do not select **Transfer**.)

- Select  (Local Directory), and select the desired contact to complete the transfer.
- Select  (Local Calls), and select the desired list. Select the desired entry to complete the transfer.

Performing a Blind Transfer Conveniently

You can perform a blind transfer conveniently by dragging the far-site window to a target speed dial or BLF key, or to another one.

It is not available to T58W phones.

Procedure

You can do one of the following:

- When there is an active call for the account which is related with the speed dial or BLF key. Drag the far-site window to that speed dial or BLF key.

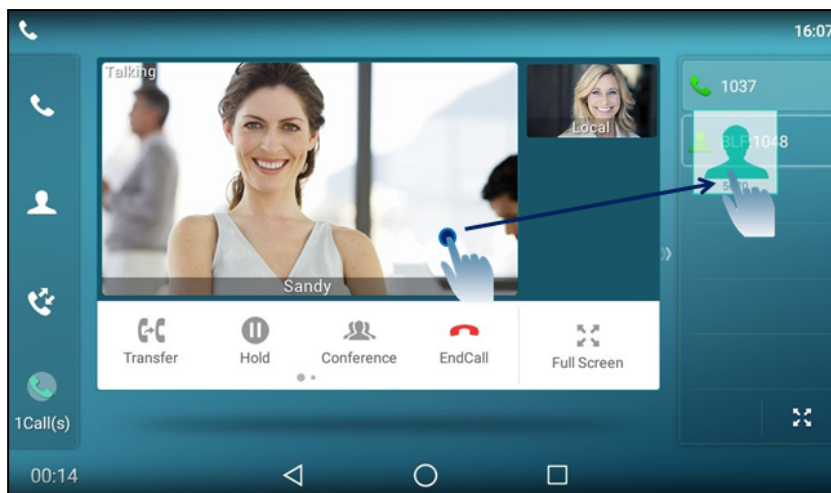

Then the call is connected to the number specified in the **Value** field of the speed dial or BLF key.

- When there is an active call and one or more calls on hold, drag the active far-site window to another held one.



And then tap **Transfer** from the screen.

The active call is connected to the number of the held party.





Related Topics

- [Setting a BLF Key](#)
- [Placing a Call with a Speed Dial Key](#)



Performing a Semi-Attended/Attended Transfer

You can transfer calls to other contacts immediately when receiving ringback or after consulting with them first.

Procedure

1. Press the TRANSFER key  or select **Transfer** during a call.
2. Do one of the following:
 - Enter the number you want to transfer the call to.
Select **Transfer** > **Send** to dial out. (For T58W, select  to dial out.)
 - Select , (Local Directory), and select the desired contact to dial out.
 - Select , (Local Calls), and select the desired entry to dial out.

3. Do one of the following:

- When you hear the ringback tone, press the TRANSFER key  or select **Transfer** to finish the semi-attended transfer.
- After the contact answers the call, press the TRANSFER key  or select **Transfer** to finish the attended transfer (consultative transfer).

Tip: If you are using a handset, the transfer can be completed by hanging up the handset.

Performing Transfer with a Transfer Key

By default, you can transfer a call to a specific contact directly using a Transfer key during a call.

Your system administrator can also set your phone to perform attended transfer when using a Transfer key.

Topics

[Setting a Transfer Key](#)

[Performing a Blind Transfer Using a Transfer Key](#)



[Performing a Semi-attended/Attended Using a Transfer Key](#)

[Performing a Call Transfer by Selecting a Transfer Mode](#)

Setting a Transfer Key

You can set a line key as a Transfer key, and specify a contact you want to transfer a call to for this key.

Procedure

1. Swipe left or right to go to the second idle screen.
2. Go to **Settings > Features > Dsskey**.
3. Select the desired line key.
4. Select **Key Event** from the **Type** field.
5. Select **Transfer** from the **Key Type** field.
6. Do one of the following:
 - (Optional.) Enter the string that will appear on the phone screen in the **Label** field.
Enter the contact number you want to transfer the call to in the **Value** field.
 - Select  and select the desired contact.
7. Select .

Tip: By default, you can drag the line key to the **Edit** field to set it.

Performing a Blind Transfer Using a Transfer Key

After you have set a Transfer key with a specific contact, you can perform a blind transfer by using it.

Before You Begin

Confirm with your system administrator that the transfer mode has set to perform a blind transfer.

Procedure

1. Tap the Transfer key during a call.
The call is transferred to the specific contact directly.

Related Topic

[Setting a Transfer Key](#)

Performing a Semi-attended/Attended Using a Transfer Key

After you have set a Transfer key with a specific contact, you can perform a semi-attended/attended transfer by using it.

Before You Begin

Confirm with your system administrator that the transfer mode has set to perform attended transfer.

Procedure

1. Tap the Transfer key during a call.
The phone calls the specific contact first. Wait until you hear the ringback tone or until the contact answers the call.
2. Tap the Transfer key again.

Related Topic

[Setting a Transfer Key](#)

Performing a Call Transfer by Selecting a Transfer Mode

During the call, you can press the Transfer key to select a transfer mode.

Before You Begin

You need to set a Transfer key for a specific contact. Check with your system administrator to find out if this call transfer feature is available on the phone.

Procedure

1. Press the Transfer key during a call, the phone screen is shown below:

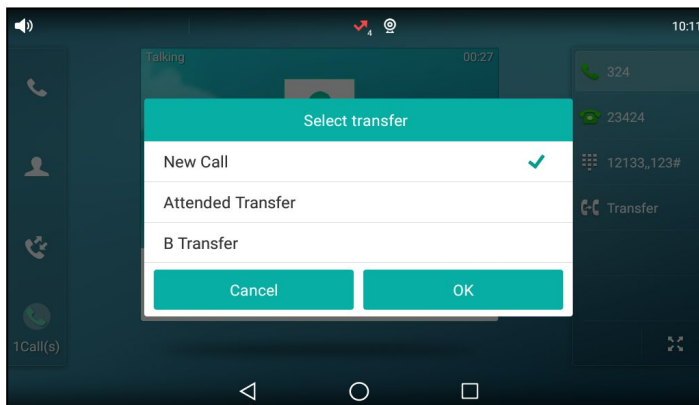

2. Select the desired transfer mode.

Related Topic

[Setting a Transfer Key](#)

Conference Calls

The phone supports creating local conference and network conference.

During the conference, follow these tips:

- Use the handset or a headset if you're in an open environment.
- Mute your microphone when you are not speaking, especially in noisy environments.

- Avoid tapping or rustling papers near the microphone.
- Speak in your normal voice without shouting.

Topics

[Local Conference](#)

[Network Conference](#)

Local Conference

You can create up to ten-way audio-only and video mixed local conference including a maximum of three-way video calls.

Topics

[Setting Up a Local Conference Call](#)

[Merging Two Calls into a Conference](#)

[Creating a Hybrid Conference](#)

[Creating a Multi-Party Conference with a Conference Key](#)

[Holding or Resuming a Conference Call](#)

[Muting or Unmuting a Conference Call](#)

[Splitting a Conference Call](#)

[Managing Conference Participants](#)

[Ending a Conference Call](#)

Setting Up a Local Conference Call

Procedure

1. Place a call to the first party.
2. Select **Conference** to place a new call.
For T58W, select **Invite**.
The active call is placed on hold.
3. Dial the second party's number.
4. On the T58A/VP59 phones, when the second party answers the call, select **Conference** to add the second party to the conference.
5. Repeat the above steps to add more parties to the conference.

Note: On the T58W phones, you can also select  > **Send** to dial out several parties at the same time.

Merging Two Calls into a Conference

You can invite a held call into a conference call with the active call.

Procedure

1. Place two calls on the phone.
2. Do one of the following:
 - Drag one far-site window to another far-site window (not available to T58W).

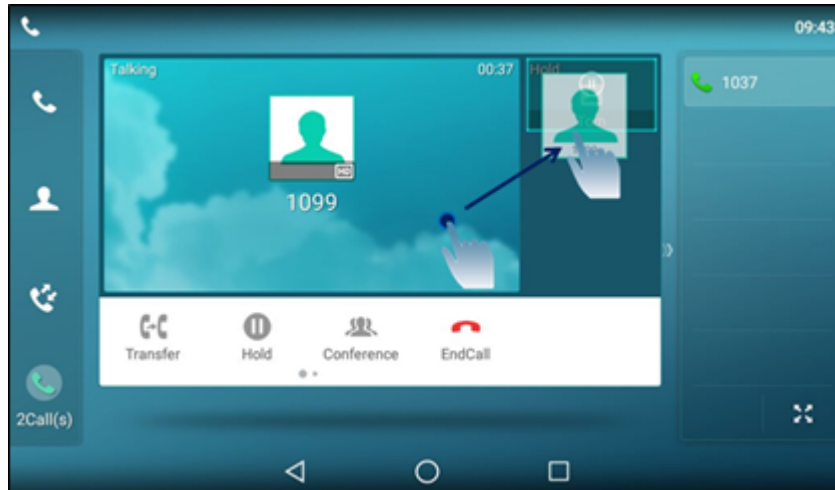

And then tap **Conference** from the pop-up box.

- Tap the desired active call for a conference and tap **Conference**.
On the T58W phones, select **Invite**.
Tap the Hold call to join the calls in the conference.

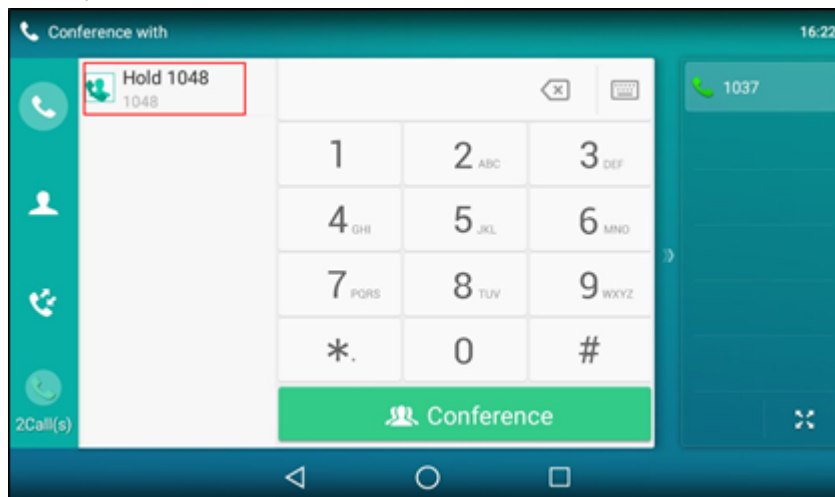

Creating a Hybrid Conference

You can merge the calls on your phone, and connected mobile phone into a hybrid conference.

There are many ways to create a hybrid conference, the following shows an example.

Before You Begin

Make sure you have connected a mobile phone to your phone.

Procedure

1. Place a mobile call over Bluetooth on the mobile phone.
2. Place a call on the phone.
3. Tap **Conference**.
On the T58W phones, select **Invite**.
4. Tap the hold call.

The calls are merged into a conference call.

Related Topic

[Pairing and Connecting the Bluetooth-enabled Mobile Phone](#)

Creating a Multi-Party Conference with a Conference Key

You can create a multi-party conference using a Conference key on the idle screen.

Topics

[Setting a Conference Key](#)

[Initiating a Multi-Party Conference](#)

Setting a Conference Key

You can set a conference key to create a multi-party conference.

Procedure

1. Swipe left or right to go to the second idle screen.
2. Go to **Settings** > **Features** > **Dsskey**.
3. Select the desired line key.
4. Select **Key Event** from the **Type** field.
5. Select **Conference** from the **Key Type** field.
6. (Optional.) Enter the string that will appear on the phone screen in the **Label** field.
7. Select .

Initiating a Multi-Party Conference

You can call all contact numbers at a time to initiate a multi-party conference.

Before You Begin

You have set a conference key on the phone.

Procedure

1. Select the conference key on the idle screen.
2. Do one of the following:
 - Enter all contact numbers you want to add to the conference.
 - Select **History** or **Directory** to select the desired contact.

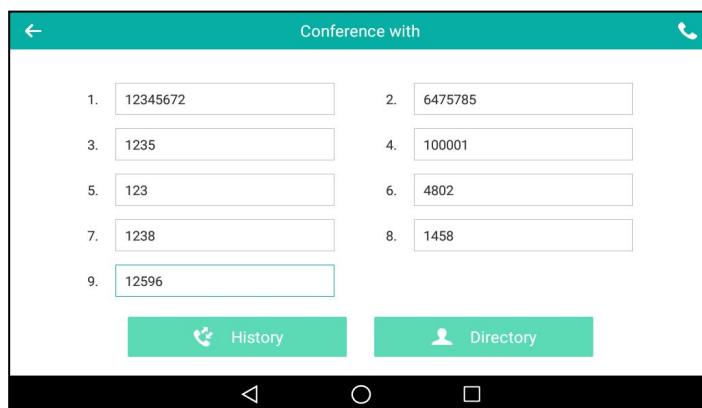

3. Select  or **Call**.



Related Topic

Setting a Conference Key

Holding or Resuming a Conference Call

When you place a conference call on hold, other participants cannot hear each other until you resume the held conference call.

Procedure

1. Press the HOLD key  or tap **Hold** to place the conference on hold.
2. Press the HOLD key  again or tap **Resume** to resume the held conference call.

Muting or Unmuting a Conference Call

When you mute the local microphone during a conference call, other participants can hear each other except you.

Procedure

1. Press the MUTE key  to mute the conference.
2. Press the MUTE key  again to unmute the conference.

Splitting a Conference Call

You can split the conference call into individual calls. After the split, the conference call ends, and other parties are held.



Procedure

1. Select **Split**.

Managing Conference Participants

You can manage the conference participants to make the conference more flexible.

Procedure

1. Long tap the desired party (on the T58W phones, select **More > Manage**), you can do the following:
 - Select **Far Mute** () to mute the party. The muted party can hear everyone, but no one can hear the muted party.
 - Select **Far Hold** () to hold the party. The held party cannot hear anyone, and no one can hear the held party.
 - Select **Remove** () to remove the party from the conference call.

Ending a Conference Call

When you end the conference call, the other parties drop the call.

However, the system administrator can set up your phone so that the other two parties remain connected when you end the conference call.

Procedure

1. Select **End Call**.

Network Conference

If your system administrator has set a network conference feature on your phone, you can initiate a conference with two or more contacts.

Topic

[Setting Up a Network Conference](#)

Setting Up a Network Conference

You can set up a network conference with multiple parties.

Procedure

1. Place a call to the first party.
2. Select **Conference** to place a new call.
For T58W, select **Invite**.
The active call is placed on hold.
3. Dial the second party's number.
4. On T58A/VP59 phones, when the second party answers the call, select **Conference** to add the second party to the conference.
5. Repeat the above steps until you add all parties.

The conference is set up after the intended parties answer the call.

Note: The Procedures for setting up a network conference call on specific servers may be different from the introduction above. Contact your system administrator for more information.

Call Recording

You can record up to 12 hours in one file. By default, the recorded files are saved in the internal SD card.

But if there is a USB flash drive connected to the rear USB port of your phone, the recorded files will be saved in the storage device according to the priority: USB flash drive > internal SD card.

Recording using a USB flash drive is not available by default. Contact your system administrator for enabling this feature for you.

Topics

- [Recording a Call](#)
- [Recording a Conference](#)
- [Setting a Mark When Recording a Call](#)
- [Stopping a Recording](#)
- [Checking Storage Space](#)

Recording a Call

You can record the important parts during an active call.

Important: Before call recording, especially those involving PSTN, it is necessary to know about the rules and restrictions of call recording in the country where you are. It is also very important to inform all the call parties that you are recording and ask for their consent before recording the conversation.

Procedure

1. During a call, swipe the soft key area left and then select **Record**.
For T58W, select **More > Record**.
The phone screen displays a recording icon and recording duration.

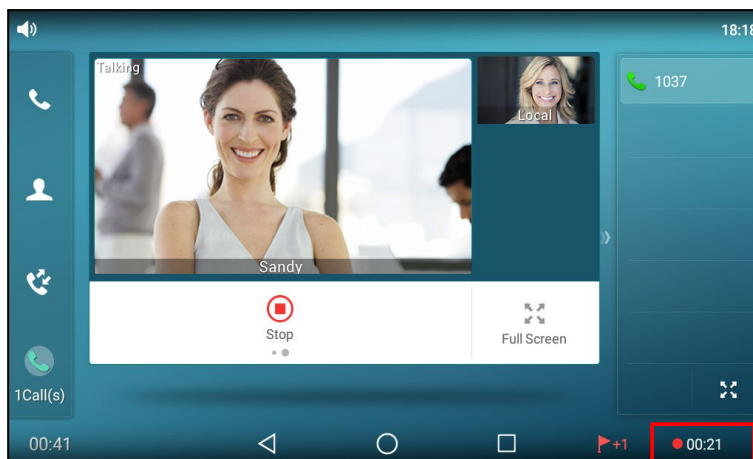

Recording a Conference

You can record conference calls in the same way as other calls. All conference participants are recorded while recording.

The following lists exceptions:

- If one of the participants holds the conference call, only that participant is recorded. When a conference call is placed on hold, recording of the conference is paused. You can place or answer other calls, which will be recorded in the same file. When the conference call is resumed, recording of the conference resumes.
- If one of the participants mutes the conference call, only that participant is not recorded.

Related Topics

[Recording a Call](#)

Setting a Mark When Recording a Call

You can set a mark when recording a call to mark the special moment. And there will be a red flag on this moment when playing the recorded file so that you can drag to the moment quickly.

Procedure

1. Select .

The icon changes to , the number will increase if you set more marks.

Stopping a Recording

You can stop recording a call before the call ends. The recording also stops when the active call ends. The recording will be saved as a "*.aac" file in the internal SD card or the USB flash drive automatically.

Procedure

1. Do one of the following:
 - Swipe the soft key area left and then select **Stop** during a call.
For T58W, select **More > Stop**.

The recording icon and recording duration disappears. The screen prompts a message that the call is recorded successfully.

- Select **End Call**.

The recording icon and recording duration disappears, and the phone returns to the idle screen. The screen prompts a message that the call is recorded successfully.

Checking Storage Space

You can check the total space or available space of the phone or connected USB flash drive.

Procedure

1. Swipe left or right to go to the second idle screen.
2. Go to **Settings > Status > Storage**.

Multicast Paging

Multicast Paging allows you to broadcast instant audio announcements to users who are listening to a specific multicast group on a specific channel.

The phone supports the following 31 channels:

- **0**: Broadcasts are sent to channel 0. Note that the Yealink IP phones running old firmware version (old paging mechanism) can be regarded as listening to channel 0. It is the default channel.
- **1 to 25**: Broadcasts are sent to channel 1 to 25. We recommend that you specify these channels when broadcasting with Polycom IP phones which have 25 channels you can listen to.
- **26 to 30**: Broadcasts are sent to channel 26 to 30. We recommend that you specify these channels when broadcasting with Yealink IP phones running new firmware version (new paging mechanism).

Note: All IP phones in the multicast paging group must be deployed in the same subnet since a broadcast is used. The phone can only send/receive broadcasts to/from the listened channels. Other channels' broadcasts will be ignored automatically by the IP phone.

Topics

[Sending Multicast Paging](#)
[Receiving Multicast Paging](#)
[Managing a Paging Call](#)

Sending Multicast Paging

Your phone supports up to 31 groups for paging. You can assign a label to each group to identify the phones in the group, such as All, Sales, or HR.

You can set a line key as Multicast Paging key or Paging List key on the phone, which allows you to send announcements to the phones with pre-configured multicast address(es) on specific channel(s).

Note: Multicast RTP is one way only from the sender to the multicast address(es) (receiver). For outgoing RTP multicasts, all other existing calls on the phone will be placed on hold.

Topics

[Setting a Multicast Paging Key](#)
[Sending a Paging by a Multicast Paging Key](#)
[Setting a Paging List Key](#)
[Setting a Paging Group](#)
[Sending Pages by a Paging List Key](#)
[Deleting a Paging Group](#)

Setting a Multicast Paging Key

You can set a Multicast Paging key for a paging group, which allows you to send announcements quickly on the idle screen.

Before You Begin

Get the multicast IP address and port number from your system administrator.

Procedure

1. Swipe left or right to go to the second idle screen.
2. Go to **Settings > Features > Dsskey**.
3. Select the desired line key.
4. Select **Key Event** from the **Type** field.
5. Select **Multicast Paging (Paging)** from the **Key Type** field.
6. (Optional.) Enter the paging group name in the **Label** field.
7. Enter the multicast IP address and port number (for example, 224.5.6.20:10008) in the **Value** field.
8. Enter the desired channel between 0 and 30 in the **Channel** field.
9. Select .

Tip: By default, you can drag the line key to the **Edit** field to set it.

Sending a Paging by a Multicast Paging Key

You can send a paging by using the Multicast Paging key when the phone is idle.

Before You Begin

You need to set a Multicast Paging key in advance.

Procedure

1. Tap the Multicast Paging key when the phone is idle.

Both your phone and receiver's phone play a warning tone and the multicast RTP session will be automatically answered on the receiver's phone in the speakerphone (hands-free) mode.

The multicast paging key icon will become  and solid.

The following figure shows a multicast RTP session on the phone:

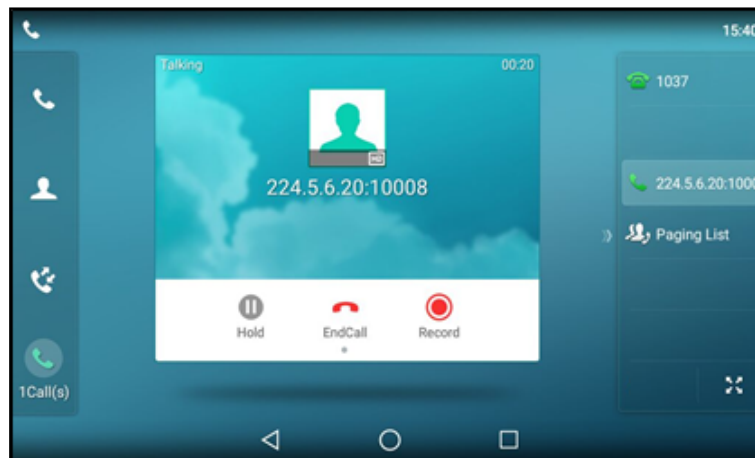

Related Topic

[Setting a Multicast Paging Key](#)

Setting a Paging List Key

You can set a Paging List key to easily access the paging groups on the idle screen.

Procedure

1. Swipe left or right to go to the second idle screen.
2. Go to **Settings > Features > Dsskey**.
3. Select the desired line key.

4. Select **Key Event** from the **Type** field.
5. Select **Paging List** from the **Key Type** field.
6. (Optional.) Enter the string that will display on the phone screen in the **Label** field.
7. Select .

Tip: By default, you can drag the line key to the **Edit** field to set it.



Setting a Paging Group

You can edit the information of the paging group.

Before You Begin

A Paging List key is set in advance. Get the multicast IP address and port number from your system administrator.

Procedure

1. Tap the Paging List key when the phone is idle.
2. Select  after the desired paging group.
The default tag is Empty if it is not configured before.
3. Enter the multicast IP address and port number (for example, 224.5.6.20:10008) in the **Address** field.
4. Enter the string that will display on the phone screen in the **Label** field.
5. Enter the desired channel between 0 and 30 in the **Channel** field.
6. Select .
7. To set more paging groups, repeat steps 2 to 6.

Sending Pages by a Paging List Key

You can send a paging by using the Paging List key when the phone is idle.

Before You Begin

You need to set a Paging List key in advance.

Procedure

1. Tap the Paging List key when the phone is idle.
2. Select the desired paging group.
Both your phone and receiver's phone play a warning tone and the multicast RTP session will be automatically answered on the receiver's phone in the speakerphone (hands-free) mode.

Related Topic

[Setting a Paging List Key](#)

Deleting a Paging Group

You can delete any group from the paging group list.

Procedure

1. Tap the Paging List key when the phone is idle.
Go to **Settings > Features > Paging List**.
If the Paging List key is not configured, you can also swipe left or right to go to the second idle screen. And then go to **Settings > Features > Paging List** to configure the paging list.
2. Select  after the desired paging group.
3. Select **Delete**.

The phone prompts you to delete the paging group or not.

4. Select **OK**.

If you want to delete all paging groups, you can tap  on the top-right of the phone screen.

Receiving Multicast Paging

Your system administrator has set a listening paging group for you, you can automatically receive a paging call when the phone is idle.

When there is a voice call or a paging call in progress, the phone handles the new paging call differently according to the multicast listening settings configured by your system administrator.

Managing a Paging Call

During a paging call, you can manage it manually at any time.

Procedure

- Select **Hold** to place the current paging call on hold.
The paging call is placed on hold and the receiver releases the session.
- Select **Resume** to resume the held paging call.
The multicast RTP session is re-established.
- Select **Record** to record a call.
- Select **End Call** to end the paging call.

Sharing Content during a Call

During the call, you can share content with the far site from the computer, that is installed the Yealink VC Desktop application.

It is not available to T58W phones.

Note: If you change the call status, for example, hold a call or perform a call transfer, the content sharing automatically stops. During the conference call, you cannot share content with other parties. The matching Yealink VC Desktop application version is 1.28.0.1.

Before You Begin

Make sure that INFO signaling traversal or upgrading the audio call to the video call is supported by your server.

Scene 1-Far site supports video

During the video call, party A shares content from the computer using Yealink VC Desktop with party B. Party A and party B temporarily exit the video call, and phone A prompts that it is sharing contents, and the far-site window of phone B displays the shared content from party A. After the sharing, party A can continue the video call with the party B.

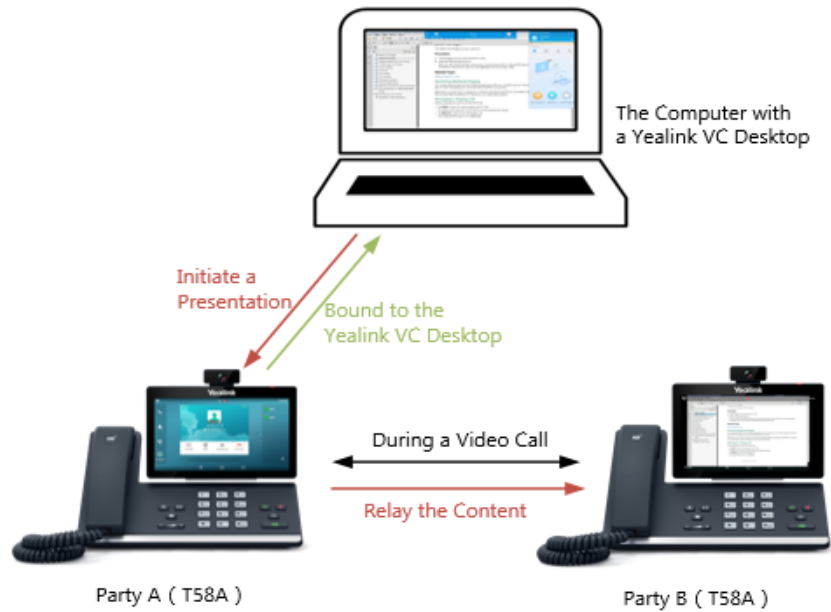

Scene 2-Far site does not support video

During the call, party A shares content from the computer A using Yealink VC Desktop with party B. Phone A prompts that it is sharing content, and the Yealink VC Desktop on computer B displays the shared content from party A.

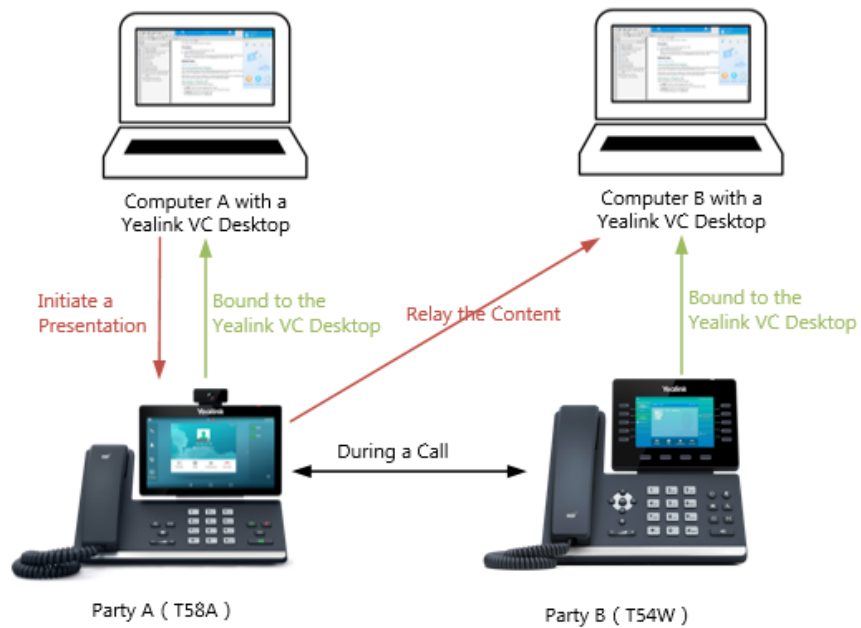

Procedure

1. Bind your phone to the Yealink VC Desktop.
2. Share content with another phone using Yealink VC Desktop.

For more information, see [Yealink VC Desktop User Guide](#).

Advanced Call Features

You can perform some server-dependent tasks on the phone. Contact your system administrator to find out if your phone supports these advanced call features.

Topics

[Using Call Completion](#)

[Call Pickup](#)

[Call Park and Call Retrieve](#)

[Busy Lamp Field \(BLF\)](#)

[BLF List](#)

[Shared Line](#)

[Intercom](#)

[Video/Voice Mail](#)

[Using the Hot Desking](#)

[Automatic Call Distribution \(ACD\)](#)

Using Call Completion

When you call someone who is temporarily unavailable to answer the call, you can monitor the busy party and establish a call after the busy party becomes available to receive a call.

Note: Call completion is not available on all servers. For more information, contact your system administrator.

Procedure

1. Swipe left or right to go to the second idle screen.
2. Go to **Settings > Features > Call Completion**.
3. Turn on **Call Completion**.
4. Select .

When you place a call and the callee is temporarily unavailable to answer the call, the phone prompts whether to wait for the callee, select **OK** to activate the call completion feature.

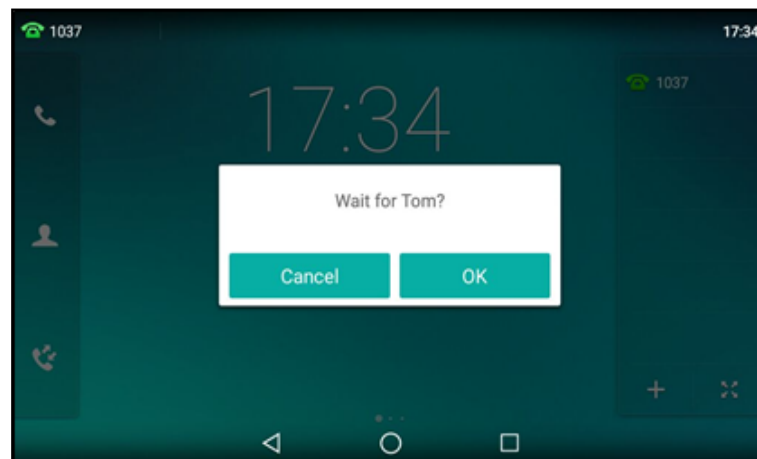

When the callee becomes idle, the phone prompts whether to dial the number, select **OK** to dial the number.

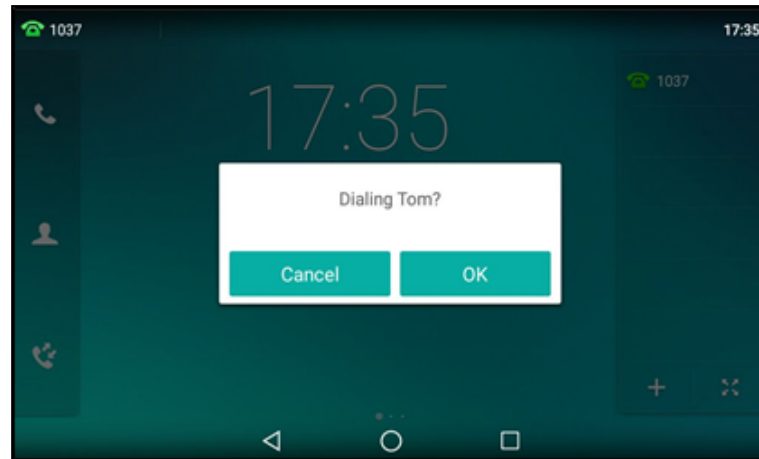

Call Pickup

You can use call pickup to answer someone else's incoming call on your phone.

The phone supports the following two call pickup features:

- **Directed Call Pickup:** allows you to pick up incoming calls to another phone.
- **Group Call Pickup:** allows you to pick up incoming calls to any phone within a predefined group.

Check with your system administrator to find out if this feature is available on your phone.

Topics

[Picking up a Call Directly](#)

[Picking up a Group Call Directly](#)

[Picking up a Call with a Pick Up Key](#)

[Picking up a Call with a Group Pickup Key](#)

Picking up a Call Directly

You can answer a call that rings on another phone.

Before You Begin

The target phone receives an incoming call. Your system administrator has enabled the directed call pickup and set the directed call pickup code.

Procedure

1. Pick up the handset, press the Speakerphone key  or tap the line key.

The DPickup (Pick Up) appears on the phone screen.

2. Select **DPickup (Pick Up)** on your phone.
3. Enter the phone number which is receiving an incoming call.
4. Select **DPickup (Pick Up)** again.

The call is answered on your phone.

Tip: When the phone is idle, you can use a Directed Pickup or BLF/BLF List key to pick up a call to a specific contact directly.

Related Topics

[Picking up a Call with a Pick Up Key](#)

[Picking up a Remote Call by BLF Key](#)

[Picking up a Remote Call by BLF List Key](#)

Picking up a Group Call Directly

When any phone within a predefined group receives an incoming call, you can pick up that call on your phone.

If there are multiple incoming calls on the group at the same time, you can only pick up the first incoming call.

Before You Begin

Your system administrator has enabled the group call pickup and set the group call pickup code.

Procedure

1. Pick up the handset, press the Speakerphone key  or tap the line key.

*The **GPickup** appears on the phone screen.*

2. Select **GPickup** on your phone when any phone in the group receives an incoming call.

The call is answered on your phone.

Tip: When the phone is idle, you can use a Group Pickup key to pick up a group call directly.

Related Topic

[Picking up a Call with a Group Pickup Key](#)



Picking up a Call with a Pick Up Key

You can easily use a Pick Up key to pick up a call to a specific contact's phone.

Before You Begin

Ask your system administrator for the directed call pickup code.

Procedure

1. Swipe left or right to go to the second idle screen.
2. Go to **Settings > Features > Dsskey**.
3. Select the desired line key.
4. Select **Key Event** from the **Type** field.
5. Select **DPickup (Pick Up)** from the **Key Type** field.
6. Select the desired line from the **Account ID** field.
7. Do one of the following:
 - (Optional.) Enter the string that will display on the phone screen in the **Label** field.
Enter the directed call pickup code followed by the specific extension in the **Value** field.
 - Select  and select the desired contact.
8. Select .

Tip: By default, you can drag the line key to the **Edit** field to set it.

When the target phone receives an incoming call, you can press the Pick Up key, and the call is answered on your phone.



Picking up a Call with a Group Pickup Key

You can easily select a Group Pickup key to pick up a group call.

Before You Begin

Check with your system administrator if the group call pickup code is required for this key. If required, get the group call pickup code from your system administrator.

Procedure

1. Swipe left or right to go to the second idle screen.
2. Go to **Settings > Features > Dsskey**.
3. Select the desired line key.
4. Select **Key Event** from the **Type** field.
5. Select **Group Pick Up** from the **Key Type** field.
6. Select the desired line from the **Account ID** field.
7. Do one of the following:
 - (Optional.) Enter the string that will appear on the phone screen in the **Label** field.
Enter group call pickup code in the **Value** field.
 - Select  and select the desired contact.
8. Select .

Tip: By default, you can drag the line key to the **Edit** field to set it.

When any phone within a predefined group of phones receives an incoming call, you can tap the Group Pickup key, and the call is answered on your phone.

Call Park and Call Retrieve

You can park a call, and then retrieve the call either from your phone or another phone. After parked, the call is placed on hold, you can continue the conversation after retrieving it.

Note: Call park is not available on all servers. Check with your system administrator to find out if it is available on your phone.

Topics

- [Parking or Retrieving a Call in the FAC Mode](#)
- [Parking or Retrieving a Call in the Transfer Mode](#)
- [Parking or Retrieving a Call with a Park or Retrieve Key](#)

Parking or Retrieving a Call in the FAC Mode

You can park the call to the local extension or the desired extension through dialing the park code.

Topics

- [Parking a Call in the FAC Mode](#)
- [Retrieving a Parked Call in the FAC Mode](#)

Parking a Call in the FAC Mode

You can park a call in the FAC mode directly. When you park a call to the local extension or the desired extension, the call is held in the same network on your phone.

Before You Begin

Your system administrator has set call park in the FAC mode.

Procedure

1. During a call, select **Park**.
The phone will dial the call park code which is pre-configured.

2. Do one of the following:

- If you want to park the call against the local extension, press the # key.
- If you want to park the call against the desired extension, enter the extension (for example, 4606) where you want to park the call and press the # key.

If the call is parked successfully, you will hear a voice prompt that the call is parked.

Tip: You can use a Park key or a BLF key to park a call to a specific contact directly.

Related Topics

[Parking or Retrieving a Call with a Park or Retrieve Key](#)

[Parking or Retrieving a Call by BLF Key](#)

Retrieving a Parked Call in the FAC Mode

You can retrieve a parked call in the FAC mode from any phone within your network.

Before You Begin

Your system administrator has set call park in the FAC mode. There is a call parked on the extension.

Procedure

1. Pick up the handset, press the Speakerphone key  or tap the line key.
2. Select **Retrieve Park** on the dialing screen.

The phone will dial the park retrieve code which is configured in advance.
3. Follow the voice prompt to retrieve:
 - Press the # key on the phone where the call is parked.
 - Enter the desired extension followed by # (for example, 4606#) on any phone.

Tip: When the phone is idle, you can use a Retrieve key, BLF key or BLF List key to retrieve a parked call directly.

Related Topics

[Parking or Retrieving a Call with a Park or Retrieve Key](#)

[Parking or Retrieving a Call by BLF Key](#)

[Retrieving a Call by a BLF List Key](#)

Parking or Retrieving a Call in the Transfer Mode

You can park the call to the shared parking lot through a blind transfer.

For some servers, the system will return a specific retrieve park number (park retrieve code) after parking successfully.

Topics

[Parking a Call in the Transfer Mode](#)

[Retrieving a Parked Call in the Transfer Mode](#)

Parking a Call in the Transfer Mode

You can park a call in the transfer mode directly. When you park a call to the shared parking lot, the call is held on your phone.

Before You Begin

Your system administrator has set call park in the Transfer mode.

Procedure

1. During a call, select **Park**.

The call will be directly transferred to the shared parking lot.

Tip: You can use a Call Park key to park a call to a specific shared parking lot directly.

Related Topic

[Parking or Retrieving a Call with a Park or Retrieve Key](#)

Retrieving a Parked Call in the Transfer Mode

You can retrieve a parked call in the transfer mode from any phone in the same network.

Before You Begin

Your system administrator has set call park in the Transfer mode. There is a call parked on the shared parking lot.

Procedure

1. Pick up the handset, press the Speakerphone key  or tap the line key.
2. Tap **Retrieve Park** on the dialing screen.

The phone will retrieve the parked call from the shared parking lot.

Tip: When the phone is idle, you can use a Retrieve key to retrieve a parked call directly.

Related Topic

[Parking or Retrieving a Call with a Park or Retrieve Key](#)

Parking or Retrieving a Call with a Park or Retrieve Key









You can easily use a Park key to park a call to a specific extension (if the FAC mode is set) or shared parking lot (if the Transfer mode is set), and quickly retrieve this parked call using a retrieve key.

Topics

- [State Indicator of the Park/Retrieve key](#)
- [Parking a Call using a Park Key](#)
- [Retrieving a Parked Call using a Retrieve Key](#)

State Indicator of the Park/Retrieve key

You can get the call park/retrieve status by viewing the icon indicator of the Park/Retrieve key.

Icons	Description	Icons	Description
 ()	Park successfully/Idle state.	 ()	Park failed.
 ()	Ringing state.	 ()	Retrieve parked call.

Parking a Call using a Park Key



You can set a line key as a Park key, and specify an extension or a shared parking lot you want to park a call to for this key. By using the Park key, you can park a call quickly.

Before You Begin

Check with your system administrator if the FAC or Transfer mode is set on your phone, and if **Account ID** is necessary for this key.

Procedure

1. Swipe left or right to go to the second idle screen.
2. Go to **Settings > Features > Dsskey**.

3. Select the desired line key.
4. Select **Key Event** from the **Type** field.
5. Select **Call Park** from the **Key Type** field.
6. (Optional.) Select the desired line from the **Account ID** field.
7. Do one of the following:
 - (Optional.) Enter the string that will appear on the phone screen in the **Label** field.
Enter the park extension number or the shared parking lot you want to park the call to in the **Value** field.
 - Select  and select the desired contact.
8. Select .

Tip: By default, you can drag the line key to the **Edit** field to set it.

During a call, you can tap the Call Park key, and the call is parked to the desired extension or the shared parking lot directly.



Retrieving a Parked Call using a Retrieve Key

You can set a line key as a Retrieve key, and specify a parked extension or retrieve lot you want to retrieve a parked call from for this key. By using the Retrieve key, you can retrieve a parked call quickly.

Before You Begin

Check with your system administrator if the FAC or Transfer mode is set on your phone, and if **Account ID** is necessary for this key.

Procedure

1. Swipe left or right to go to the second idle screen.
2. Go to **Settings > Features > Dsskey**.
3. Select the desired line key.
4. Select **Retrieve** from the **Type** field.
5. (Optional.) Select the desired line from the **Account ID** field.
6. Do one of the following:
 - (Optional.) Enter the string that will appear on the phone screen in the **Label** field.
Enter the parked extension or the retrieve lot in the **Value** field.
 - Select  and select the desired contact.
7. Tap .

Tip: By default, you can drag the line key to the **Edit** field to set it.

When there is a call parked on the extension or the shared parking lot, you can tap the Retrieve key on the idle screen, and the call is retrieved from the parked extension or shared parking lot directly.

Busy Lamp Field (BLF)

You can monitor a specific remote line using a BLF key for status changes on the phone.







Topics

- [State Indicator of Remote Line by BLF Key](#)
- [Audio Alert for BLF Pickup](#)
- [Visual Alert for BLF Pickup](#)
- [Setting a BLF Key](#)
- [Picking up a Remote Call by BLF Key](#)
- [Transferring a Call by BLF Key](#)

Parking or Retrieving a Call by BLF Key

State Indicator of Remote Line by BLF Key

You can get the monitored line's status by viewing the icon indicator of the BLF key.

Icons	Description	Icons	Description
	The monitored line is idle	 (Flashing)	The monitored line is ringing.
 (Flashing)	The monitored line is dialing		The monitored line is busy or in a call.
	The monitored line places a call on hold		A call is parked to the monitored line.
	The monitored line fails to register or does not exist.		

Audio Alert for BLF Pickup

The Audio Alert for BLF Pickup feature allows your phone to play a tone when the specified monitored line receives an incoming call.

Setting an Alert Tone for Monitored Lines

You can set the alert ring type for the monitored lines to make it easier to recognize.

Before You Begin

Check with your system administrator to find out if the Audio Alert for BLF Pickup feature is available.

Procedure

1. Swipe left or right to go to the second idle screen.
2. Go to **Settings > Basic Settings > Sound > BLF Ring Tones**.
3. Select the desired ring tone.
4. Select  .

Visual Alert for BLF Pickup

Your system administrator can configure your phone to display the call information when the specified monitored line receives an incoming call.

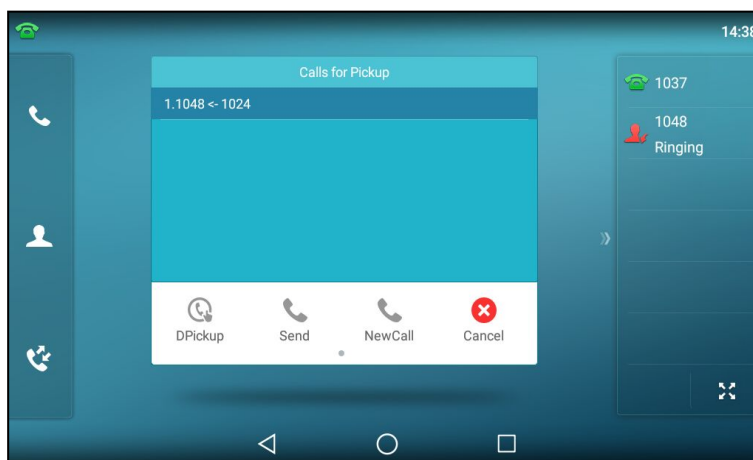

You can select to pick up the call to the monitored line, place a call to the monitored line, place a new call or go back to the idle screen.



Setting a BLF Key

You can set a BLF key to monitor a specific line for status changes on the phone.

Procedure

1. Swipe left or right to go to the second idle screen.
2. Go to **Settings > Features > Dsskey**.
3. Select the desired line key.
4. Select **BLF** from the **Type** field.
5. Select the desired line from the **Account ID** field.
6. Do one of the following:
 - (Optional.) Enter the string that will appear on the phone screen in the **Label** field.
Enter the phone number or the extension you want to monitor in the **Value** field.
 - Select  and select the desired contact.
7. (Optional.) Enter the directed call pickup code in the **Extension** field.
8. Select .

Tip: By default, you can drag the line key to the **Edit** field to set it.

Picking up a Remote Call by BLF Key

When the monitored users are not at their desks and someone rings their lines, you can pick up the desired call simply by tapping the flashing BLF key.

If your system administrator sets the directed call pickup code in advance, you can use the BLF key to pick up the call directly. If not or if you want to set a pickup code for a specific BLF line, you can set a pickup code for the BLF key manually.

Before You Begin

You have edited the BLF key's **Extension** field with the directed call pickup code from your system administrator.

Procedure

1. When the monitored line receives an incoming call, you can tap the BLF key to pick up the call for the monitored line directly.

Related Topic

[Setting a BLF Key](#)

Transferring a Call by BLF Key

When there is already an active call on the IP phones, you can transfer the active call to the monitored line by tapping the BLF key.

The phone transfers the active call differently depending on the Transfer Mode via Dsskey feature configured by your system administrator.

Topics

[Performing a Blind Transfer](#)

[Performing a Semi-attended/Attended Transfer](#)

Performing a Blind Transfer

During a call, you can transfer the call to the monitored contact in a blind-transfer way.

Before You Begin

Check with your system administrator if the Transfer Mode via Dsskey is set to **Blind Transfer**.

Procedure

1. During a call, tap the BLF key of the monitored line which you want to transfer this call to.

Performing a Semi-attended/Attended Transfer

During a call, you can transfer the call to the monitored contact in the semi-attended/attended-transfer way.

Before You Begin

Check with your system administrator if the Transfer Mode via Dsskey is set to **Attended Transfer**.

Procedure

1. During a call, tap the BLF key of the monitored line which you want to transfer this call to.
The phone will dial out the number of the monitored line.
2. Tap the BLF key of the monitored line again or **Transfer** to complete the transfer when the monitored user receives ringback or after the monitored user answers the call.

Parking or Retrieving a Call by BLF Key

You can use the BLF key to park a call or retrieve a parked call directly.

Note: Check with your system administrator to find out if it is available on your phone.

Topics

[Parking a Call to a Monitored Line](#)

[Retrieving a Parked Call](#)

Parking a Call to a Monitored Line

During the call, you can use the BLF key to park the current call to a monitored line directly.

Before You Begin

Your system administrator has set call park feature in the FAC mode in advance.

Procedure

1. During a call, select **Park**.
2. Tap the desired BLF key to park the call to the monitored line.

Retrieving a Parked Call

You can use the BLF key to retrieve a call that is parked to the monitored line.

Before You Begin

Your system administrator has set call park feature in the FAC mode.

Procedure

1. Select **Retrieve Park** on the dialing screen.
2. Press the desired BLF key to retrieve a call that is parked to the monitored line.

BLF List

BLF List feature enables you to monitor a list of users defined by your system administrator, and the respective icons will either flash or glow depending on the status of monitored lines.

Check with your system administrator to find out if this feature is available on your phone.

Topics

[State Indicator of Remote Line by BLF List Key](#)

[Audio Alert for BLF Pickup](#)

[Visual Alert for BLF Pickup](#)

[Ring Type for BLF Parked Call Monitor](#)

[Visual Alert for BLF Parked Call Monitor](#)

[Picking up a Remote Call by BLF List Key](#)

[Transferring a Call by BLF List Key](#)

[Parking a Call by a BLF List Key](#)







[Retrieving a Call by a BLF List Key](#)

[Barging in an Active Call by BLF List Key](#)

[Retrieving a Call Parked to the Monitored Line](#)

State Indicator of Remote Line by BLF List Key

You can get the monitored line's status by viewing the icon indicator of the BLF List key.

Icons	Description	Icons	Description
 ()	The monitored line is idle		The monitored line is ringing
	The monitored line is dialing		The monitored line is busy or in a call
	The monitored line places a call on hold		The monitored line fails to register or does not exist

Audio Alert for BLF Pickup

The Audio Alert for BLF Pickup feature allows your phone to play a tone when the specified monitored line receives an incoming call.

Setting an Alert Tone for Monitored Lines

You can set the alert ring type for the monitored lines to make it easier to recognize.

Before You Begin

Check with your system administrator to find out if the Audio Alert for BLF Pickup feature is available.

Procedure

1. Swipe left or right to go to the second idle screen.
2. Go to **Settings > Basic Settings > Sound > BLF Ring Tones**.
3. Select the desired ring tone.
4. Select .

Visual Alert for BLF Pickup

Your system administrator can configure your phone to display the call information when the specified monitored line receives an incoming call.

You can select to pick up the call to the monitored line, place a call to the monitored line, place a new call or go back to the idle screen.

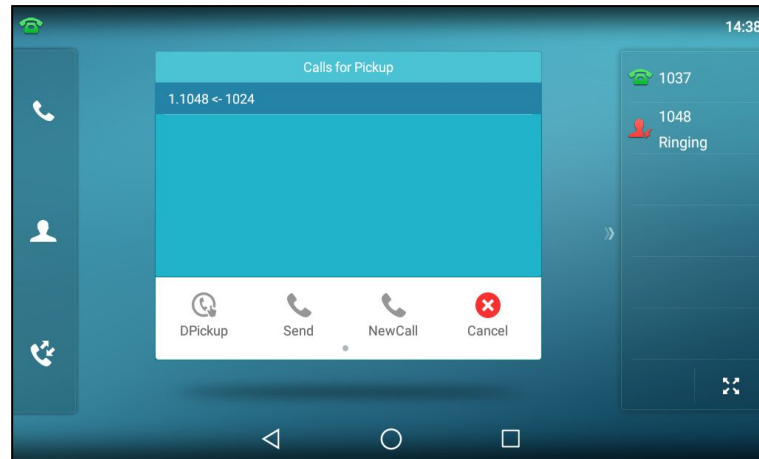

Ring Type for BLF Parked Call Monitor

The Audio Alert for BLF Parked Call Monitor feature allows your phone to play a tone when a call is parked against the monitored user's phone number.

Topic

[Setting an Alert Tone for the BLF Parked Call Monitor](#)

Setting an Alert Tone for the BLF Parked Call Monitor

You can set the alert ring type when there is a call parked to the monitored lines.

Before You Begin

Check with your system administrator to find out if the Audio Alert for BLF Parked Call Monitor feature is available.

Procedure

1. Swipe left or right to go to the second idle screen.
2. Go to **Settings > Basic Settings > Sound > Ring Type for BLF Parked Call Monitor**.
3. Select the desired ring tone.
4. Select .

Visual Alert for BLF Parked Call Monitor

Your system administrator can configure your phone to display the call information when the specified monitored line receives an incoming call.

You can select to retrieve the call parked to the monitored line, place a call to the monitored line, place a new call or go back to the idle screen.

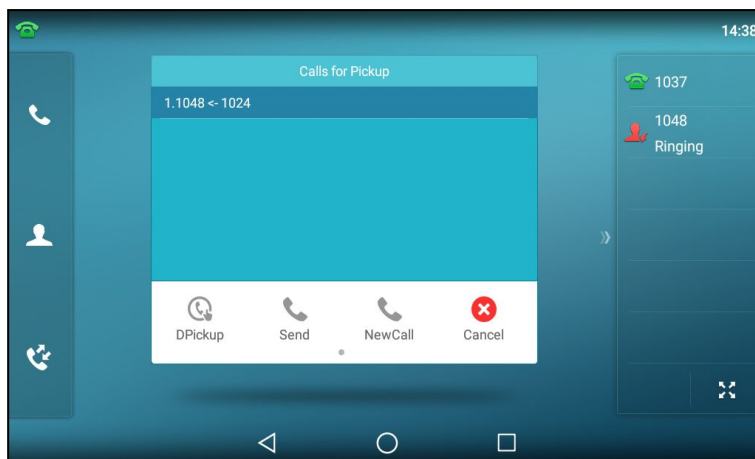

Picking up a Remote Call by BLF List Key

When the monitor user is not at his/her desk and someone rings his/her line, you can pick up the call simply by tapping the flashing BLF List key.

Before You Begin

Check with your system administrator to find out if this feature is available on your phone.

Procedure

1. Tap the BLF List key to pick up the call for the monitored line directly.

Transferring a Call by BLF List Key

When there is already an active call on the IP phones, you can transfer the active call to the monitored user by tapping the BLF List key.

The phone transfers (Blind Transfer or Attended Transfer) the active call differently depending on the Transfer Mode via Dsskey feature configured by your system administrator.

Topics

[Performing a Blind Transfer](#)

[Performing a Semi-attended/Attended Transfer](#)

Performing a Blind Transfer

During a call, you can use the BLF List key to perform a blind transfer to the monitored line.

Before You Begin

Check with your system administrator to make sure that the Transfer Mode via Dsskey is set to **Blind Transfer**.

Procedure

1. During a call, tap the BLF List key of the monitored line which you want to transfer this call to.

Performing a Semi-attended/Attended Transfer

During a call, you can use the BLF List key to perform a semi-attended/attended transfer to the monitored line.

Before You Begin

Check with your system administrator if the Transfer Mode via Dsskey is set to **Attended Transfer**.

Procedure

1. During a call, tap the BLF List key of the monitored line which you want to transfer this call to.

The phone will dial out the number of the monitored line.

2. Tap the BLF List key of the monitored user again or **Transfer** to complete the transfer when the monitored user receives ringback or after the monitored user answers the call.

Parking a Call by a BLF List Key

You can use the BLF List key to park a call to the monitored user who is idle.

Before You Begin

Check with your system administrator to find out if this feature is available on your phone.

Procedure

1. During a call, press the desired BLF List key.

Retrieving a Call by a BLF List Key

You can use the BLF List key to retrieve a call that is parked to the monitored line.

Before You Begin

Check with your system administrator to find out if this feature is available on your phone.

Procedure

1. Tap the desired BLF List key to retrieve a call that is parked to the monitored line.

Barging in an Active Call by BLF List Key

You can use the BLF List key to barge in a conversation and set up a conference call.

Before You Begin

Check with your system administrator to find out if this feature is available on your phone.

Procedure

1. Tap the BLF List key.

The phone dials out the barge-in code followed by the monitored line, and then you can join the call. Each of the three parties can hear the other two parties.

Retrieving a Call Parked to the Monitored Line

When a call is parked to the monitored line, you can retrieve the parked call on the phone.

Before You Begin

Check with your system administrator to find out if Visual Alert for BLF Parked Call Monitor is enabled on your phone.

Procedure

1. Select **Retrieve**.

Shared Line

Yealink phone supports using Shared Call Appearance (SCA) to share a line. So that this line can be registered on more than one phone at the same time.

Your system administrator can set your phone to use the shared line.

Topics

[State Indicator of Shared Line](#)

[Placing Calls on a Shared Line](#)

[Answering Calls on a Shared Line](#)

[Placing a Call on Public Hold](#)

[Placing a Call on Private Hold](#)

[Retrieving a Held Call on a Shared Line](#)











[Barging in an Active Call on a Shared Line](#)

[Pulling a Shared Call on a Shared Line](#)

State Indicator of Shared Line

You can get the shared line's status by viewing the icon indicator of the shared line key.

The following table shows all kinds of icon indicator associated with the shared line and the corresponding descriptions:

Icons	Description	Icons	Description
	The shared line is idle.	 (Monitoring SCA Phone)	The shared line is seized.
 (Flashing)	The shared line receives an incoming call.	 (Flashing)	The shared line is dialing.
	The shared line is busy or is in a call.		The call on the shared line is placed on public hold.
	The call on the shared line is barged in by the other shared line user.	 (Local SCA Phone)  (Other Phone)	The call on the shared line is placed on private hold.
	In a multi-party call, place the call on hold locally.		

Placing Calls on a Shared Line

You can place one or multiple calls on a shared line.

The phone places a call on the first shared line key automatically. You can select the desired shared line key first and place a call using this key.

Related Topic

[Placing Calls](#)

Answering Calls on a Shared Line

You can answer one or more calls on the shared line.

When an incoming call arrives on the shared line, all the registered phones will ring simultaneously, and the call can be answered on any one of the phones. Incoming calls will be distributed evenly among the available shared line keys.

Note: If the number of incoming calls is greater than the configured line keys, the line keys will be used by sequence circulation. Contact your system administrator for more information.

Related Topic

[Answering Calls](#)

Placing a Call on Public Hold

You can place a call on public hold that any shared line phone can retrieve the held call.

Procedure

1. During a call, press the HOLD key or **Hold**.

Placing a Call on Private Hold

In the SCA scenario, you can place a call on private hold that only you can retrieve the held call.

The **PriHold** soft key can be preset by your system administrator, you can also set a line key as the private hold key manually if the **PriHold** soft key is not available on your phone. You need to configure a private hold key before you place the call on private hold.

Procedure

1. Swipe left or right to go to the second idle screen.
2. Go to **Settings > Features > Dsskey**.
3. Select the desired line key.
4. Select **Key Event** from the **Type** field.
5. Select **Private Hold** from the **Key Type** field.
6. (Optional.) Enter the string that will display on the phone screen in the **Label** field.
7. Select .

Tip: By default, you can drag the line key to the **Edit** field to set it.

During an SCA call, tap the **PriHold** soft key (You may need to swipe the soft key area left to see the **PriHold** soft key), or private hold key on the phone when there is an active call on the shared line. Then the call is held on your phone, and the other phones registered with a shared line show the call is in the busy state on the shared line key. Other users on the shared line cannot resume your held call.

Retrieving a Held Call on a Shared Line

If you place a call on hold on a shared line, you can resume this call at any time. When the shared line key shows a call that is in a held state, you can resume the held call remotely from other user's phone.

Before You Begin

There is at least one call placed on public hold on the shared line.

Procedure

1. Do one of the following:
 - Select .
 - Long tap the desired line key.
*The **Cancel**, **CallPull**, **NewCall** and **Retrieve** soft keys appear on the touch screen.*
Select **Retrieve** to retrieve the call.

Barging in an Active Call on a Shared Line

In the SCA scenario, you can barge into an active call on the shared line. After you barge into a call, the call turns into a three-party conference.

Note: Only one user can barge into an active call on the shared line at a time.

Before You Begin

There is at least one active call on the shared line.

Procedure

1. Long tap the desired line key.

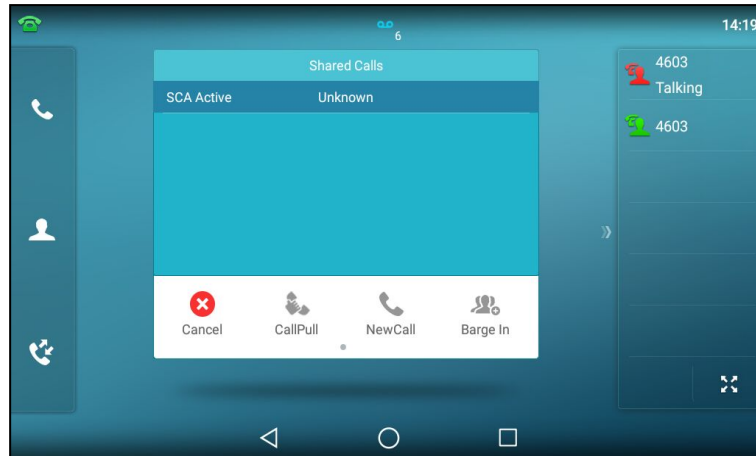

The **Cancel**, **CallPull**, **NewCall** and **Barge In** appear on the screen.

2. Select **Barge In** to interrupt the active call.

Pulling a Shared Call on a Shared Line

In SCA scenario, both you and other users can pull an existing call from another shared phone that is in an active or hold state.

Check with your system administrator to find out if this feature is available for your phone.

Before You Begin

There is an active or held call on the shared line.

Procedure

1. Long tap the shared line key.

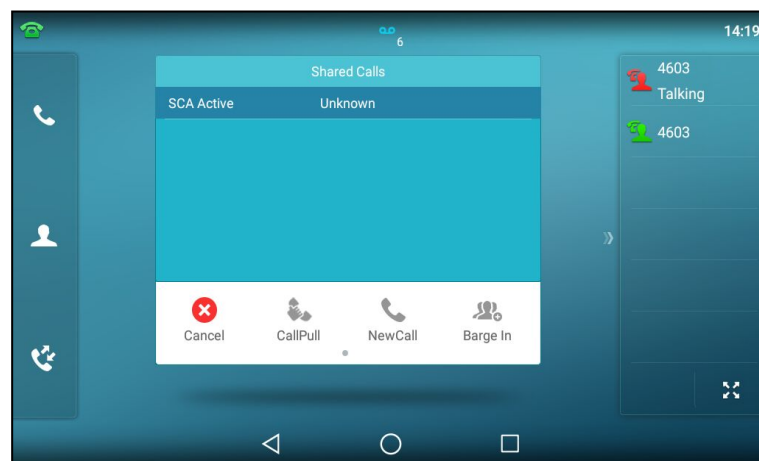

2. Select **CallPull** to pull the call.

Intercom

Intercom is a useful feature in an office environment to quickly connect with the operator or the secretary.

Intercom enables you to place an intercom call that is answered automatically on the contact's phone as long as the contact is not in an active call.





Note: Intercom is not available on all servers. Contact your system administrator for more information.

Topics

[State Indicator of the Intercom key](#)
[Placing an Intercom Call](#)
[Picking up an Incoming Call of the Target Extension](#)
[Answering an Intercom Call](#)

State Indicator of the Intercom key

You can get the intercom status by viewing the icon indicator of the Intercom key.



Icons	Description	Icons	Description
	Target extension is available.		Target extension is ringing.
 Callout	Target extension is dialing.	 Talking	Target extension is busy or is in a call.
	Target extension fails to register.		

Placing an Intercom Call

You can place an intercom call to quickly relay a message to a contact.

The target phone plays a warning tone and automatically answers the call in speakerphone (hands-free) mode by default. When the target phone has an active call, the intercom call is answered automatically after the active call ends.

Procedure

1. Swipe left or right to go to the second idle screen.
2. Go to **Settings > Features > Dsskey**.
3. Select the desired line key.
4. Select **Intercom** from the **Type** field.
5. Select the desired line from the **Account ID** field.
6. Do one of the following:
 - (Optional.) Enter the string that will appear on the phone screen in the **Label** field.
Enter the target extension number in the **Value** field.
 - Select  and select the desired contact.
7. Select .
8. Tap the Intercom key to place an intercom call.

Tip: By default, you can drag the line key to the **Edit** field to set it.

Related Topic

[Setting a BLF Key](#)

Picking up an Incoming Call of the Target Extension

You can pick up the target extension's incoming call by pressing the Intercom key.

Before picking up an incoming call, make sure that the directed call pickup code has been configured either for an Intercom key or for Call Pickup feature in advance.

Check with your system administrator to find out if this feature is available on your phone.

Note: If the directed call pickup code is not set, the phone will place a call to the target extension instead of picking up an incoming call of the target extension when you tap the Intercom key.

Before You Begin

Get the directed call pickup code from your system administrator.

Procedure

1. Drag the Intercom key to the **Edit** field.
2. Enter the directed call pickup code in the **Extension** field.
3. Select .

When the target extension receives an incoming call, the Intercom key icon of the target extension will change to



. Tap the Intercom key to pick up the incoming call directly.

Answering an Intercom Call

By default, when there is an incoming intercom call, the phone plays a warning tone and automatically answer the incoming call.

During the intercom call, you can switch among the Speakerphone (hands-free), Handset and headset modes. If your phone is set to answer intercom calls with your microphone muted, you need to press the Mute key to unmute your microphone before responding to the call.

You can configure the following behaviors when receiving an intercom call.

Intercom Allow

Intercom Allow feature allows the phone to automatically answer an incoming intercom call. If you disable this feature, the phone will reject incoming intercom calls and send a busy message to the caller.

Note: Your system administrator can set a period of delay time before the phone automatically answers intercom calls.

Intercom Mute

Intercom Mute feature allows the phone to mute the microphone when incoming intercom calls are answered automatically.

Intercom Tone

Intercom Tone feature allows the phone to play a warning tone before answering an intercom call automatically.

Intercom Barge

Intercom Barge allows the phone to automatically answer an incoming intercom call while an active call is in progress. The active call will be placed on hold. If you disable this feature, the phone will handle an incoming intercom call like a normal incoming call while there is already an active call on the phone.

Note: To enable the phone to receive a new incoming call when it already has an active call, make sure that the call waiting feature is enabled on the phone in advance.

Procedure

1. Swipe left or right to go to the second idle screen.
2. Go to **Settings**>> **Features** > **Intercom**.
3. Make the desired changes.
4. Select .

Related Topics

[Switching Among the Handset, Speakerphone and Headset Modes](#)
[Muting/Unmuting Audio](#)
[Answering a Call When in a Call](#)

Video/Voice Mail

Voice mail feature allows you to leave voice/video mails for someone or listen to your voice/video mail messages on your phone. This feature is set up on the server side and not all servers support this feature.

To send video mails, you need to connect a USB camera to the phone in advance. The usage of video mail is the same as that of voice mail, the following takes voice mail as an example.

Topics

[Setting the Voice Mail Code](#)

[Leaving Voice Mails](#)

[Listening to Voice Mails](#)



Setting the Voice Mail Code

If you want to connect your phone to the message center, you need to set the voice mail code on your phone.

Before You Begin

Get the voice mail code from your system administrator.

Procedure

1. Swipe left or right to go to the second idle screen.
2. Select  () to launch **Message**.
3. Select **Set Voice Mail Code**.
4. Enter the voice mail code (for example, *4) in the desired account field.
5. Select .

Leaving Voice Mails

You can leave a voice mail to someone who is busy or inconvenient to answer the call.

Procedure

1. Follow the voice prompts to leave a voice mail.
2. Hang up to complete the voice mail.



Listening to Voice Mails

You can listen to your voice mails on the phone, to obtain a voice information sent by a contact.



Before You Begin

You need to set the voice mail code in advance.

Procedure

1. Swipe left or right to go to the second idle screen.
2. Select  () to launch **Message**.
3. Select **View Voice Mail**.

The phone screen displays the amount of new and old voice mails. You can tap the account to listen to voice mails.

Tip: When The phone prompts that the phone receives a new voice mail, you can press the MESSAGE key  () or select **Connect** to dial out the voice mail access code directly.

Related Topic

[Setting the Voice Mail Code](#)

Using the Hot Desking

You can use hot desking to log out from the current account and then log in to a new account. So many users can share one phone resource at different times.

Note: Hot desking is not available on all servers. Contact your system administrator for more information.

Before You Begin

Your system administrator has set a Hot Desking key for you to use this feature. Get the login account information from your system administrator.

Procedure

1. Tap the hot desking key when the phone is idle.
The phone prompts you to clear the account configuration or not.
2. Select **OK**.
Registration configurations of all accounts on the phone will be cleared immediately.
The login wizard will be displayed.
3. Enter the login information.
4. Select .

Automatic Call Distribution (ACD)

ACD is often used in offices for customer service, such as call center.

The ACD system handles large volumes of incoming calls from callers who have no need to talk to a specific person but who require assistance from any of multiple persons at the earliest opportunity. ACD on all IP phones allows the ACD system to distribute large volumes of incoming calls to the registered ACD users.





ACD is not available by default. Check with your system administrator to find out if this feature is available on your phone.

Topics

- [State Indicator of ACD User](#)
- [Logging into the ACD System](#)
- [Changing the ACD Status](#)

State Indicator of ACD User

You can get the ACD user's status by viewing the icon indicator of the ACD key.

Icons	Description	Icons	Description
	Available/Log in		Wrap up
	Unavailable		Log out

Logging into the ACD System

After logging into your ACD account, you are ready to receive calls from the ACD system.

Before You Begin

Your system administrator has set an ACD key for you to log into the ACD system. Get your ACD account information from your system administrator.

Procedure

1. Tap the ACD key when the phone is idle.
2. Enter your ACD account information.
3. Select **Login**.

Changing the ACD Status

You can tap the ACD key to change your current ACD user status.

Procedure

1. Select **Available /Unavailable**.

ACD user status synchronizes on both the phone and ACD system.

2. To log out of the ACD system, select **Logout**.

Directory

The phone provides several types of phone directories, which can be customized by your system administrator.

Topics

[Local Directory](#)
[Blocklist](#)
[Mobile Contacts](#)
[Google Contacts](#)
[Remote Phone Book](#)

Local Directory

You can store up to 1000 contacts and 48 groups in your local directory, you can search, add, edit and delete a contact.

Topics

[Managing the Local Directory Groups](#)
[Managing the Local Directory Contacts](#)
[Moving a Local Directory Contact to Blocklist](#)
[Moving a Local Directory Contact to the Shared Directory](#)
[Searching for Contacts](#)

Managing the Local Directory Groups

You can manage the Local Directory groups when the phone is idle.



Topics

[Adding Contact Groups](#)
[Editing Contact Groups](#)
[Deleting Contact Groups](#)

Adding Contact Groups

To organize your contacts and make them easier to find, you can add additional groups in the Local Directory.



Procedure

1. Go to  > **Settings** > **New Group**.
For T58W, go to  > **...** > **Add Group**.
2. Enter the desired group name.
3. Select  .

Editing Contact Groups

You can change or add the group's information.

Procedure

1. Go to  > **Settings**.
For T58W, select .
2. Select  after the desired group.

For T58W, select  after the desired group and then select **Rename**.

3. Edit the group name.
4. Select .

Deleting Contact Groups

When you delete a contact group, the contacts in the group will not be deleted. You can view the contacts in **All Contacts (Local Directory)** list.

Procedure

1. Go to  > **Settings**.

For T58W, tap .

2. Select  before the desired group name.

For T58W, select  after the desired group and then select **Delete**.

The phone prompts you to delete the group or not.

3. Select **OK**.

Managing the Local Directory Contacts

You can manage the Local Directory contacts when the phone is idle.

Topics

[Adding Contacts](#)

[Viewing Contacts](#)

[Editing Contacts](#)





[Deleting a Contact](#)

[Deleting All Contacts](#)

Adding Contacts

When you add a contact to your Local Directory, you can choose how much information you want to enter for your contact. You are required to enter a contact name at least for each new contact.



Procedure

1. Select  (.
2. If you want to add a contact to the specified contact group, select the contact group first.
3. Select  (.
4. Enter your contact's information.
5. Select the desired account from the **Account** field.
6. Select the desired photo from the **Photo** field.
7. Select  or **OK**.

Viewing Contacts

You can view the local contacts from the Local Directory on your phone.

Procedure





1. Select  (.
2. If you want to view a contact to the specified contact group, select the contact group first.

The contact names are displayed in alphabetical order.

Editing Contacts

You can update your contacts' information.





Procedure

1. Select  (.
2. If you want to view a contact to the specified contact group, select the contact group first.
3. Select  after the desired contact.
For T58W, tap the desired contact and then select .
4. Edit the contact information.
5. Select  or **OK**.

Deleting a Contact

You can delete any contact from the Local Directory.





Procedure

1. Select  (.
2. If you want to delete a contact from the specified contact group, select the contact group first.
3. Select  after the desired contact.
For T58W, tap the desired contact and then select .
4. Select **Delete**.
The phone prompts you to delete the contact or not.
5. Select **OK**.

Deleting All Contacts

You can delete all contacts from the Local Directory.



Procedure



1. Select  (.
2. Select **Settings**.
For T58W, tap .
3. Select **Select All**.
4. Select .
- The phone prompts you to delete all contacts or not.*
5. Select **OK**.

Moving a Local Directory Contact to Blocklist

You can move a contact in the Local Directory to blocklist. Incoming calls from this contact will be rejected automatically.

Procedure

1. Select  (.
2. If you want to select a contact to the specified contact group, select the contact group first.

3. Select  after the desired contact.
For T58W, tap the desired contact and then select .

4. Select **Blocklist**.
For T58W, select **Move to Blocklist**.
The phone prompts you to move this contact to the blocklist or not.

5. Select **OK**.





Moving a Local Directory Contact to the Shared Directory

You can move a contact in the Local Directory to the shared directory, so that you can share the contacts with other handsets.

Before You Begin

Make sure the Shared Directory is available on your phone.

Procedure

1. Select  ().
2. If you want to select a contact to the specified contact group, tap the contact group first.
3. Select **Settings**.
For T58W, tap .
4. Select a contact.
5. Select  > **New Entry**.
6. Select  or **OK**.



Related Topic

[Shared Directory](#)

Searching for Contacts

In the Local Directory, you can enter search criteria to find your desired contact quickly.

Procedure

1. Select  (.
2. Do one of the following:
 - Select **Search** or .
 - Enter your search criteria in the search field.
 - Select the desired letter (for example, T) along the right side to jump to contacts whose names start with T or t.

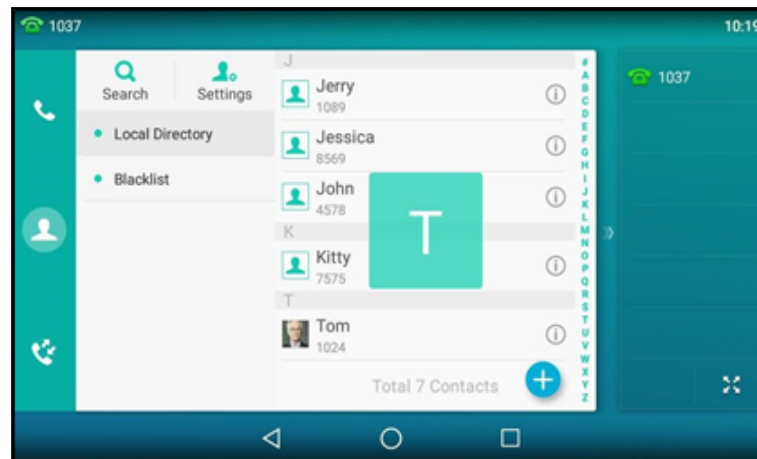

Blocklist

Incoming calls from the Blocklist are rejected automatically. You can store up to 30 contacts in the blocklist to block unwanted callers.

Topics

[Adding a Blocklist Contact](#)

[Viewing Blocklist Contacts](#)

[Editing a Blocklist Contact](#)

[Deleting a Blocklist Contact](#)

[Moving a Blocklist Contact to the Local Directory](#)

Adding a Blocklist Contact

You can add a blocklist contact on the phone to prevent someone from calling you.

Procedure

1. Go to () > **Blocklist**.
2. Select (+).
3. Enter the blocklist contact's information.
4. Select or **OK**.

Viewing Blocklist Contacts

You can view the blocklist contacts from the Blocklist on your phone.

Procedure

1. Go to () > **Blocklist**.

Editing a Blocklist Contact

You can update your blocklist contacts' information.

Procedure

1. Go to () > **Blocklist**.
2. Select (i) after the desired blocklist contact.

For T58W, tap the desired contact and then select .

3. Edit the blocklist contact information.
4. Select  or **OK**.

Deleting Blocklist Contacts

You can delete one or all blocklist contacts. If a contact is removed from the blocklist, you can answer the call from the contact normally.





Topics

- [Deleting a Blocklist Contact](#)
- [Deleting All Blocklist Contacts](#)

Deleting a Blocklist Contact

If you want to answer a call from a specific contact, you need to remove it from the Blocklist.





Procedure

1. Tap  () > **Blocklist**.
2. Select  after the desired blocklist contact.
For T58W, tap the desired blocklist contact and then select .
3. Select **Delete**.
The phone prompts you to delete the contact or not.
4. Select **OK**.

Deleting All Blocklist Contacts

You can delete all contacts from the Blocklist when you are ready to answer calls from them again.





Procedure

1. Go to  () > **Blocklist**.
2. Tap **Settings** > **Select All**.
For T58W, tap  > **Select All**.
3. Select .
4. Select **OK**.
The phone prompts you to delete all contacts or not.

Moving a Blocklist Contact to the Local Directory

You can move a blocklist contact to a Local Directory. Incoming calls from this contact will not be rejected automatically.

Procedure

1. Tap  () > **Blocklist**.
2. Select  after the desired blocklist contact.
For T58W, tap the desired contact and then select .

3. Select **Local Directory** from the **Group** field.
4. Select  or **OK**.

Mobile Contacts

You can synchronize the contacts on your mobile phone to your IP phone. The mobile phone contacts will be imported to your IP phones and stored under the Mobile Contacts directory.

You can save mobile contacts to the local directory, but you cannot save a local contact to the Mobile Contacts directory.

Note: If you disconnect the Bluetooth-enabled mobile phone from phone or disable the phone to synchronize phone contacts, the mobile contacts will not be displayed.

Topics

- [Saving a Mobile Contact to the Local Directory](#)
- [Searching for Mobile Contacts](#)
- [Updating the Mobile Contacts](#)





Saving a Mobile Contact to the Local Directory

You can save any mobile contact to the Local Directory, to conveniently call this contact after disconnecting the mobile phone from the phone.

Before You Begin

Make sure your Bluetooth-enabled mobile phone has been paired with your IP phones, and mobile contact sync feature is enabled.

Procedure

1. Select  () > **Mobile Contacts**.
2. Select  after the desired contact.
3. Select **Local Directory** from the **Group** field.
For T58W, tap the desired contact and then select  > **Add**.
4. Edit the contact information.
5. Select  or **OK**.

Related Topics

- [Pairing and Connecting the Bluetooth-enabled Mobile Phone](#)
- [Syncing the Mobile Contacts to the Phone](#)

Searching for Mobile Contacts

In Mobile Contacts, you can enter search criteria to find your desired mobile contact quickly.

Before You Begin

Make sure your Bluetooth-enabled mobile phone has been paired with and connected to your IP phones, and mobile contact sync feature is enabled.

Procedure

1. Select  () > **Mobile Contacts**.
2. Do one of the following:

- Select **Search** or  .
Enter your search criteria.
The contacts whose name or phone number matches the search string will be displayed in the result list.
- Select the desired letter (for example, T) along the right side to jump to the contacts whose names start with T or t.

Related Topics

[Pairing and Connecting the Bluetooth-enabled Mobile Phone](#)
[Syncing the Mobile Contacts to the Phone](#)

Updating the Mobile Contacts

You can update the Mobile Contact to synchronize the contacts you add, edit, and delete on the mobile phone to your phone.

Before You Begin

Make sure your Bluetooth-enabled mobile phone has been paired with and connected to your phones, and mobile contact sync feature is enabled.

Procedure

1. Select  () > **Mobile Contacts**.
2. Select .

The phone prompts “Updating, please wait...”.

Note: If you disconnect the mobile phone from the phone when the phone is updating the Mobile Contacts, the phone screen will prompt “Fail to download mobile contacts!”, and the mobile contacts disappear from the phone directory list.

Related Topics

[Pairing and Connecting the Bluetooth-enabled Mobile Phone](#)
[Syncing the Mobile Contacts to the Phone](#)

Google Contacts

You can enable the Google Contacts feature to get contacts from your Google account. The contacts are imported to your phone under Google Contacts directory.

Topics

[Enabling the Google Contacts Feature](#)
[Viewing Google Contacts](#)
[Adding a Google Contact](#)
[Editing a Google Contact](#)
[Deleting a Google Contact](#)
[Searching for Google Contacts](#)
[Manually Updating the Google Contacts](#)

Enabling the Google Contacts Feature

You need to enable the Google Contacts feature first if you want to get contacts from your Google account.

Before You Begin

Make sure you have added a Google account to your phone.

Procedure

1. Swipe left or right to go to the second idle screen.
2. Go to **Settings** > **Basic Settings** > **Google Contacts**.
3. Mark the **On** radio box.



Related Topic

[Adding APP Accounts](#)

Viewing Google Contacts

After enabling the Google contacts feature, you can view a list of the Google contacts on your phone.

Procedure

1. Go to  () > **Google Contacts**.
2. Drag up and down to scroll through the Google contacts list.
3. Tap  beside the desired contact.
For T58W, tap the desired contact.
The detailed information of the entry appears on the phone screen.

Related Topic

[Enabling the Google Contacts Feature](#)





Adding a Google Contact

You can add a Google contact on your phone directly. The operation will sync on the Google contact server.

Before You Begin

Make sure the Google Contacts feature is enabled.

Procedure

1. Go to  () > **Google Contacts**.
2. Tap  ().
3. Enter the contact's information.
4. Tap .

Note: When you first add a Google contact, a message is displayed to confirm that your new contact will be synchronized with your Google account.





Related Topic

[Enabling the Google Contacts Feature](#)

Editing a Google Contact

You can edit the Google contact's detailed or latest information on your phone. The operation will sync on the Google contact server.

Procedure





1. Go to  () > **Google Contacts**.
2. Tap  beside the desired contact.
For T58W, tap the desired contact and then select .

3. Tap the desired field to edit the contact information.
4. Tap  or **OK**.

Deleting a Google Contact

You can delete any contact in the Google Contacts. The operation will sync on the Google contact server.



Procedure

1. Go to  () > **Google Contacts**.
2. Tap  beside the desired contact.
For T58W, tap the desired contact and then select .
3. Tap **Delete**.
The phone prompts you to delete the contact or not.
4. Tap **OK**.

Searching for Google Contacts

In the Google Contacts, you can enter search criteria to find your desired Google contact quickly.

Procedure

1. Go to  () > **Google Contacts**.
2. Tap **Search** or .
3. Enter a few continuous characters of the contact name or continuous numbers of the contact number (office, mobile or other number).
The contacts whose name or phone number matches the entered characters will display in the result list.

Manually Updating the Google Contacts

The Google contacts may be updated on the Google Contact Server, you can update Google contacts on your phone to get the newest Google contacts.

Note: Network may affect the contacts synchronization. You can try to sync contacts from Google via syncing APP accounts information.

Procedure

1. Go to  () > **Google Contacts**.
2. Tap .

Related Topic

[Syncing APP Account Information](#)

Remote Phone Book

If the Remote Phone Book feature has been enabled by your system administrator, you can access your corporate directory directly from your phone.

Topics

[Searching for Remote Phone Book Contacts](#)

[Viewing Remote Phone Book Contacts](#)



[Saving a Remote Phone Book Contact to the Local Directory](#)

[Saving a Remote Phone Book Contact to the Blocklist](#)

Searching for Remote Phone Book Contacts

In the Remote Phone Book, you can enter search criteria to find your desired contact quickly.

Procedure

1. Select  () > **Remote Phone Book**.
2. Select the desired remote phone book.
3. Do one of the following:
 - Select **Search** or  .
Enter your search criteria in the search field.
 - Select the desired letter (for example, T) along the right side to jump to contacts whose names start with T or t.

Viewing Remote Phone Book Contacts

You can view the contact list of the remote phone book on your phone.





Procedure

1. Tap  () > **Remote Phone Book**.

Saving a Remote Phone Book Contact to the Local Directory

You can save any remote phone book contact to the Local Directory, to conveniently call this contact when you cannot access the remote phone book.





Procedure

1. Select  () > **Remote Phone Book**.
2. Select the desired remote phone book.
3. Select  after the desired contact.
For T58W, tap the desired contact and then select .
4. Select **Add**.
5. Select **Local Directory** from the **Group** field.
6. Select  or **OK**.

Saving a Remote Phone Book Contact to the Blocklist

You can save any remote phone book contact to the Blocklist on the phone, to prevent this contact from calling you.

Procedure

1. Select  () > **Remote Phone Book**.
2. Select the desired remote phone book.
3. Select  after the desired contact.
For T58W, tap the desired contact and then select .
4. Select **Add**.
5. Select **Blocklist** from the **Group** field.
6. Select  or **OK**.

Call History

The call history list includes Missed Calls, Placed Calls, Received Calls and Forwarded Calls, and each list holds 100 entries.

Topics

[Call History Icons](#)

[Viewing History Records](#)

[Saving a History Record to Local Directory](#)

[Saving a History Record to Blocklist](#)





[Adding a History Record to Shared Directory](#)

[Deleting History Records](#)

[Disabling History Record](#)

Call History Icons



Each icon in the Call History indicates the corresponding call history status.

Icons	Description	Icons	Description
	Received Call		Missed Call
	Placed Call		Forwarded Call

Viewing History Records

The history record saves the call information such as the caller's name and number, local line and call duration.





Procedure

1. Tap  ()
2. Select the desired list.
3. Select  after the desired entry.

Saving a History Record to Local Directory

To identify someone's call the next time, you can save a history record to the Local Directory.





Procedure

1. Select  ()
2. Select the desired list.
3. Select  > **Add**.
4. Edit the contact information.
5. Select  or **OK**.

Saving a History Record to Blocklist

You can prevent someone from calling you again by saving a history record to Blocklist.

Procedure

1. Tap  (.
2. Select the desired list.
3. Select  > **Blocklist**.
4. Edit the contact information.
5. Select  or **OK**.





Adding a History Record to Shared Directory

After you view your history record, you can add the entry to the Shared Directory.

Before You Begin

Make sure the Shared Directory is available on your phone.

Procedure

1. Select  (.
2. Select the desired list.
3. Select  after the desired entry.
4. Select **Add**.
5. Select **Share Directory** from the **Group** field.
6. Edit the corresponding fields.
7. Select .

Related Topic

[Shared Directory](#)

Deleting History Records

You can delete one or all call records from the call history list.



Topics

[Deleting a Call Record](#)
[Deleting All Call Records](#)

Deleting a Call Record

You can delete any call record from the call history list.





Procedure

1. Tap  (.
2. Select the desired list.
3. Tap  after the desired entry, and then tap **Delete**.
The phone prompts you to delete the record or not.
4. Select **OK**.

Deleting All Call Records

You can delete all call records from the call history list.

Procedure

1. Select  ().
2. Select the desired list.
3. Select **Settings**.
For T58W, tap .
4. Select **Select All**.
5. Select .
The phone prompts you to delete all the records or not.
6. Select **OK**.

Disabling History Record

If you disable history record, you cannot save any call log on the phone.

Procedure

1. Swipe left or right to go to the second idle screen.
2. Go to **Settings** > **Features** > **History Record**.
3. Turn off **History Record**.
4. Select .

System Applications

The system applications are pre-installed on your phone and they cannot be uninstalled.

Topics

[Managing Applications and Widgets](#)

[Managing Running Applications](#)

[APP Accounts](#)

[File Manager](#)

[Gallery](#)

[Recorder](#)

[Email](#)

[Browser](#)

[Calendar](#)

[Calculator](#)

[Clock](#)

Managing Applications and Widgets

You can add widgets to the idle screen for easy use, and adjust the location of applications and widgets.

Topics

[Adding a Widget to the Idle Screen](#)

[Resizing a Widget](#)

[Moving an Application or Widget](#)

[Removing a Widget from the Idle Screen](#)

[Creating a Folder](#)

[Renaming a Folder](#)

Adding a Widget to the Idle Screen

The phone provides widgets like analog clock, calendar, digital clock, email and photo gallery. You can conveniently add these widgets to the idle screen as preferred.

Before You Begin

If you want to add an email widget, and you have not registered an APP account, a wizard will be provided for you to set up the email account. If you want to add a photo widget, you need to choose the album or images to be displayed. You cannot add this widget if there are no images in the photo gallery.

Procedure

1. Long tap the empty spot on the idle screen.
2. Tap **WIDGETS**.
3. Touch and hold to pick up a widget.
4. Drag the desired widget up/down/left/right to the destination spot on the idle screen.

Resizing a Widget

Some widgets such as calendar, digital clock and email can be resized on the idle screen.

Procedure

1. Long tap the desired widget for about 2 seconds, and then lift your finger from the screen.

The widget will be with a white frame as shown below:

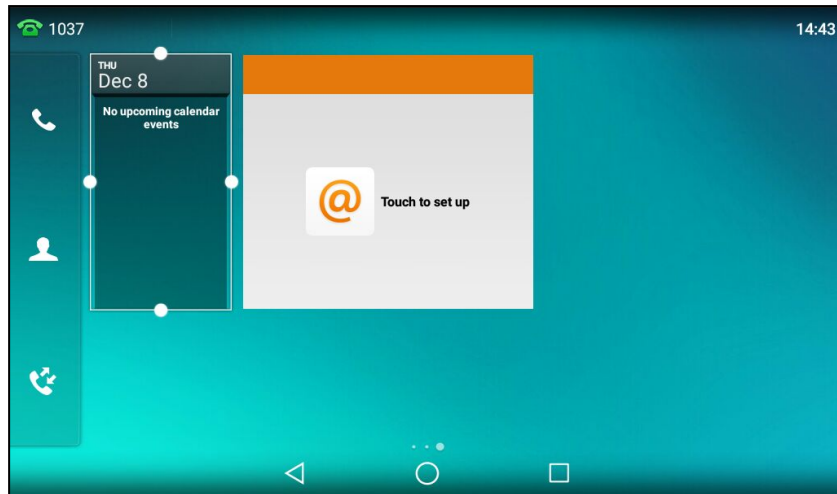

2. Drag the border of the frame to adjust the size.

Moving an Application or Widget

You can move an application or widget to a different spot on the idle screen or to a different idle screen.

Before You Begin

Before moving an application or widget, you should know the following:

- You can drag an application or widget to the rightmost of the third idle screen to add a new screen.
- If there is only one application or widget on the screen, you cannot add a new screen.
- The idle screen (except the home screen) will be deleted automatically if there is no application or widget on it.

Procedure

1. Long tap the desired item for about 2 seconds.
2. Drag the item up/down/left/right to the destination spot on the screen.

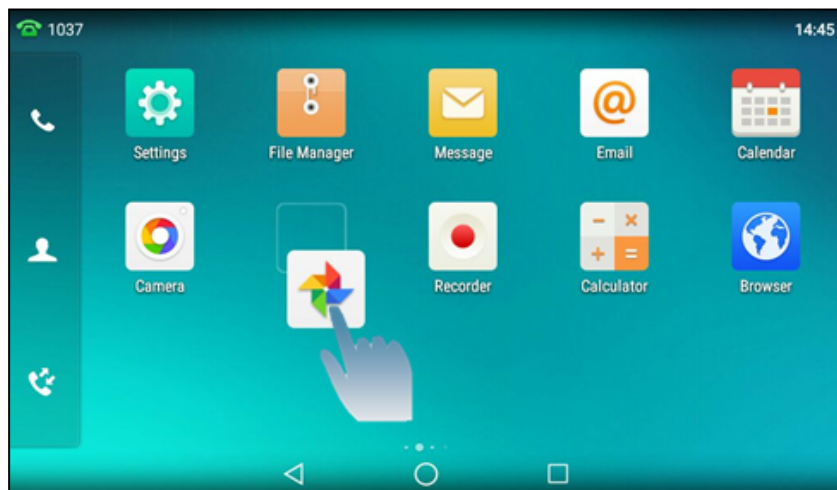

Removing a Widget from the Idle Screen

Removing operation only removes the widget of the application from the screen. The application itself will not be uninstalled.

Procedure

1. Long tap the desired item for about 2 seconds.

The **Remove** field will appear on the top of the phone screen.

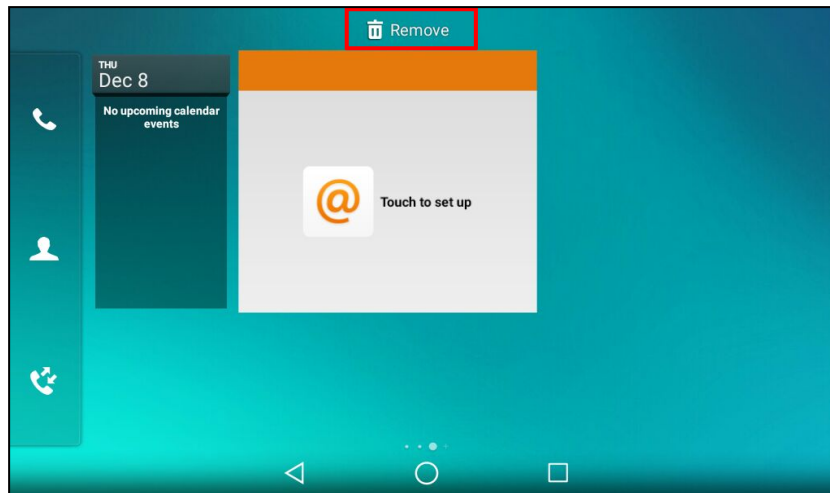

2. Drag the item to the **Remove** field to remove it.

Creating a Folder

You can create a folder to organize your applications. For example, you can place the same kind of applications in a folder.

It is not available to T58W phones.

Procedure

1. Drag an application icon over another application icon.

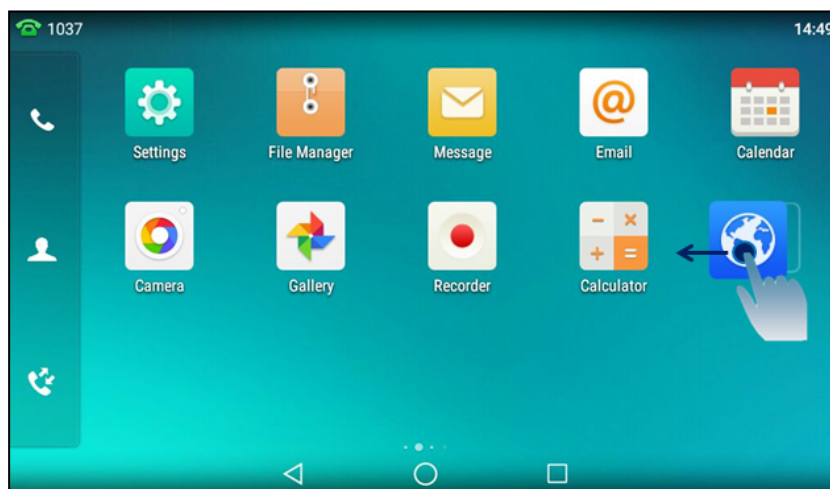

2. Lift your finger when a folder frame appears around the applications.

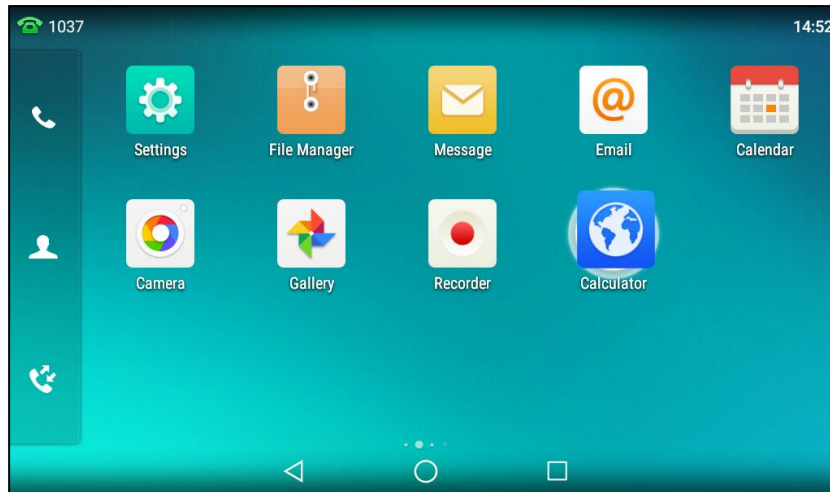

A new folder containing the selected applications is automatically created.

The folder will be deleted automatically if there is only one application in the folder.

Renaming a Folder

You can rename a folder to make it easier to be recognized.

It is not available to T58W phones.

Procedure

1. Tap the desired folder to expand the folder.

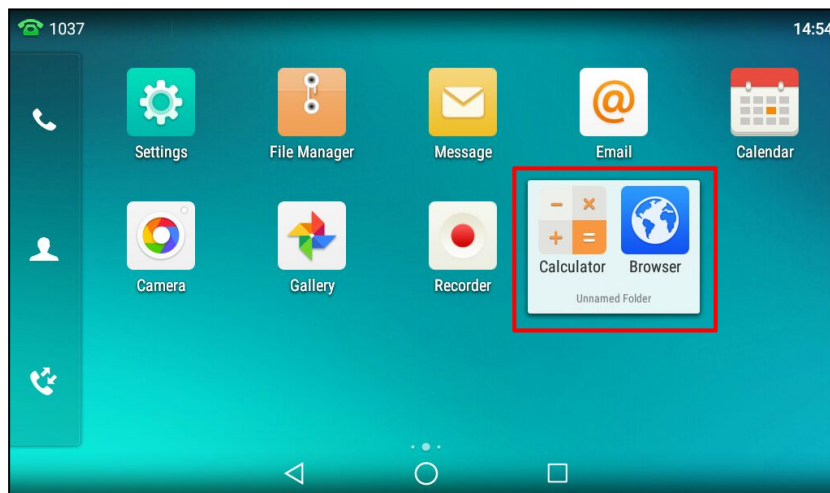

2. Tap the **Unnamed Folder** field.
3. Enter the desired folder name.
4. Tap **Done** on the onscreen keyboard.
5. Tap the blank area of the phone screen.

The folder name is renamed.

Managing Running Applications

You can tap to view and manage the list of recently used applications that are still running in the background.

It is not available to T58W phones.

Procedure

Do one of the following:

- Swipe the desired application left or right to stop the running application.
- Tap  to stop all running applications.
- Tap the desired application to access the application.

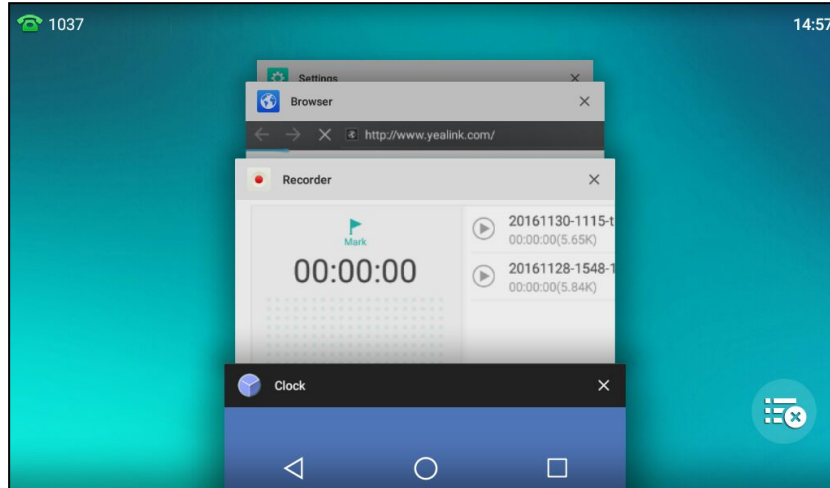

If there are no running applications, the phone screen will prompt “Your recent screens appear here”.

APP Accounts

Before using **Email** and **Calendar**, or you want to sync contacts with Google, you need to register an APP account.

Topics

[Adding APP Accounts](#)

[Syncing APP Account Information](#)

[Removing APP Accounts](#)

Adding APP Accounts

You can add Exchange, personal(IMAP), or Google accounts for your **Email** and **Calendar**. The Google account can be also used to sync the Google contacts.

Note: If you cannot add a Google account, contact your system administrator for help installing the core GMS package on your phone.

You can choose the following email account type when adding an APP account. Check with your network administrator for the correct email account settings.

- **POP3:** When using POP3, all emails are stored locally instead of on the server side.
- **IMAP:** When using IMAP, all emails are stored on the server side and you can see them from the phone or other mail clients as well.
- **Exchange:** When using Exchange, all emails are stored in the central Exchange mail server and can be checked using a compatible mail client such as Microsoft Outlook.

Procedure

1. Swipe left or right to go to the second idle screen.
2. Go to **Settings > Basic Settings > APP Accounts**.
3. Tap **Add account**.

4. Select the desired APP account type.
5. Register your APP account according to the wizard.

Syncing APP Account Information

After registering the APP account, you can sync the account information if required.

Procedure

1. Swipe left/right to go to the second idle screen.
2. Go to **Settings > Basic Settings > APP accounts**.
3. Tap the desired account type.
4. Do one of the following:
 - If you want to sync all accounts, tap **⋮ > Sync now**.

In the following example, it will sync both ll506466499@sina.com and ll506466400@sina.com information.

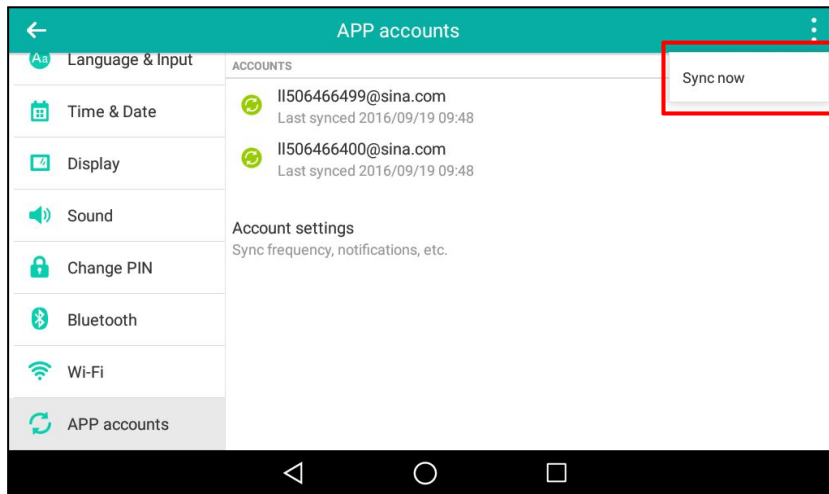

- If you want to sync a single account, select the desired account. Tap **⋮ > Sync now**.

In the following example, it will only sync ll50466499@sina.com information.

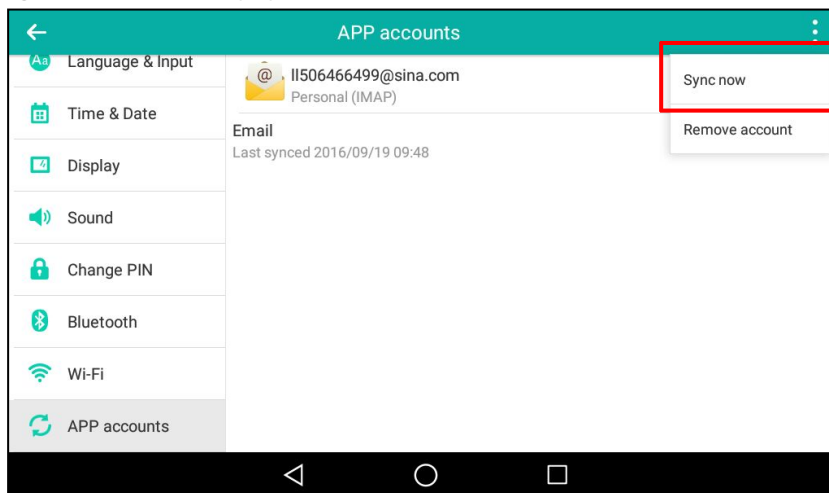

Removing APP Accounts

When you no longer use the current account, you can remove it.

Procedure

1. Swipe left/right to go to the second idle screen.
2. Go to **Settings > Basic Settings > APP accounts**.
3. Tap the desired account type.
4. Select the desired account.
5. Tap  > **Remove account**.
The phone prompts you whether to remove the account.
6. Tap **Remove account**.

File Manager

File Manager is a tool that allows you to view, search, delete, copy or move photo/video/audio files. You can also share files via Bluetooth or email. It helps you to access and manage files in the internal SD card as well as USB flash drive.

Topics

[Viewing Files](#)
[Searching Files](#)
[Copying Files](#)
[Cutting Files \(Moving Files\)](#)
[Uploading Files](#)
[Deleting Files](#)
[Sharing Pictures/Videos/Audio via Bluetooth](#)
[Sharing Pictures/Videos/Audio via Email](#)

Viewing Files

You can view photo, video and audio files on your phone.

Procedure

1. Swipe left or right to go to the second idle screen.
2. Tap  to launch **File Manager**.
3. Tap **Photos/Videos/Audios** in the **Local Storage** field.
*If a USB flash drive has been connected to your phone, you can tap **Photos/Videos/Audios** in the **USB Storage** field to view the files stored in USB flash drive.*
4. Tap the desired picture/video/audio to view.



You can also swipe down from the top of the screen to enter the control center, and then tap **USB** to launch **File Manager** to view the files if you have connected a USB flash drive to the phone.

Tip: The menu keys and Android keys will disappear after 5 seconds, you may tap the phone screen to show them again.

Searching Files

By entering search criteria, you can easily find the desired files.

Procedure



1. Swipe left or right to go to the second idle screen.
2. Tap  to launch **File Manager**.
3. Tap  on the top-right of the screen.
4. Enter a search string of the file name.

The phone screen shows the file whose name matches the search string. You can drag up and down to scroll through the searching results, and then tap the desired file to view.

Copying Files

You can copy the files that stored in the USB flash drive to internal SD card, or vice versa.

Procedure

1. Swipe left or right to go to the second idle screen.
2. Tap  to launch **File Manager**.
3. Tap **Photos/Videos/Audios** in **Local Storage** field.
If a USB flash drive has been connected to your phone, you can tap **Photos/Videos/Audios** in the **USB Storage** field to view the files stored in USB flash drive.
4. Select the check box before the desired file.
You can also select the **Select All** check box to copy all files.
5. Tap .

The following prompt will appear on the phone screen:

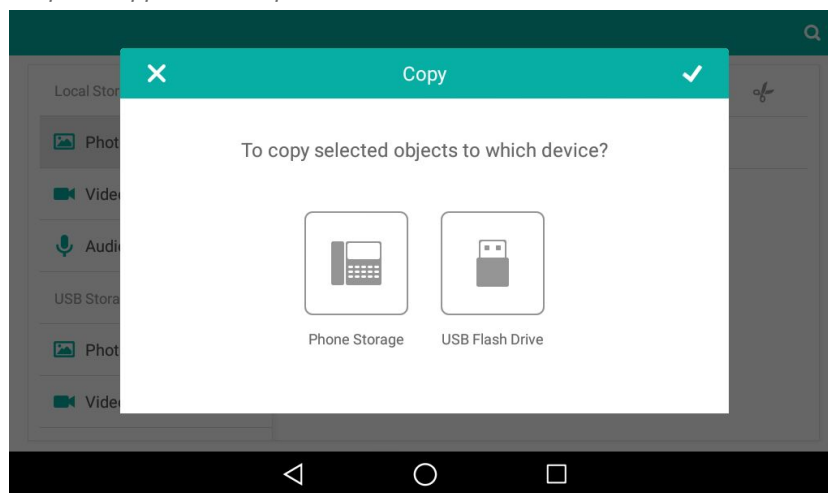



6. Tap the desired storage device.
7. Tap .

The files are copied successfully with a prompt.

Cutting Files (Moving Files)

You can move the files to other desired path. Once you move the files, they will not be kept in the original storage device any more.

Procedure

1. Swipe left or right to go to the second idle screen.
2. Tap  to launch **File Manager**.
3. Tap **Photos/Videos/Audios** in **Local Storage** field.
If a USB flash drive has been connected to your phone, you can tap **Photos/Videos/Audios** in the **USB Storage** field to view the files stored in USB flash drive.
4. Select the check box before the desired file.
You can also select the **Select All** check box to cut all files.
5. Tap .

The following prompt will appear on the phone screen:

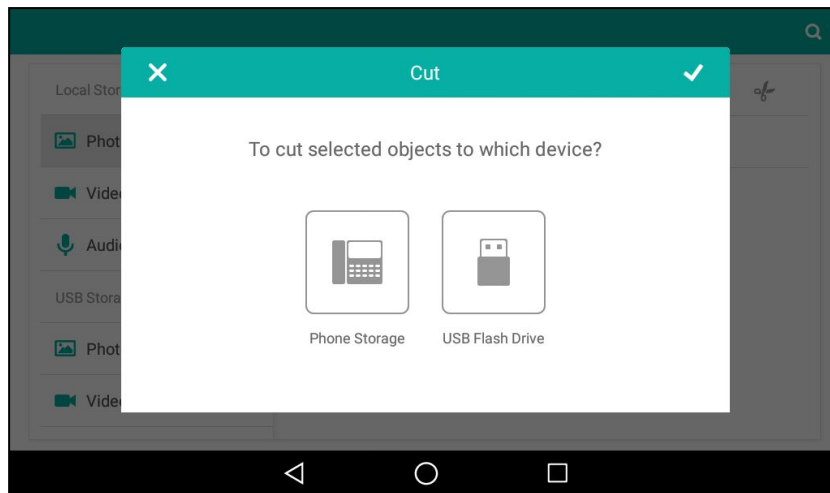



6. Tap the destination storage device.
7. Tap .

The files are cut successfully with a prompt.

Uploading Files

You can upload the files to the server designated by the administrator.

Procedure



1. Swipe left or right to go to the second idle screen.
2. Tap  to launch **File Manager**.
3. Tap **Videos/Audios** in **Local Storage** field.
If a USB flash drive has been connected to your phone, you can tap **Videos/Audios** in the **USB Storage** field to view the files stored in USB flash drive.
4. Select the check box before the desired file.
You can also select the **Select All** check box to cut all files.
5. Tap .

The file is uploaded to the server successfully with a prompt.

Deleting Files

You can delete the useless files to make room for other files.

Procedure

1. Swipe left or right to go to the second idle screen.
2. Tap  to launch **File Manager**.
3. Tap **Photos/Videos/Audios** in **Local Storage** field.
If a USB flash drive has been connected to your phone, you can tap **Photos/Videos/Audios** in the **USB Storage** field to view the files stored in USB flash drive.
4. Select the check box before the desired file.
You can also select the **Select All** check box to delete all files.
5. Tap .

The phone prompts you whether to delete the files.

6. Tap **OK**.





Sharing Pictures/Videos/Audio via Bluetooth

You can share files in the **File Manager** with other Bluetooth devices.

Before You Begin

Make sure the Bluetooth mode is enabled, and the Bluetooth device is discoverable.

Procedure

1. Swipe left or right to go to the second idle screen.
2. Tap   to launch **File Manager**.
3. Tap **Photos/Videos/Audios** in **Local Storage** field.
If a USB flash drive has been connected to your phone, you can tap **Photos/Videos/Audios** in the **USB Storage** field to view the files stored in USB flash drive.
The right of the phone screen shows all pictures/videos/audio.
4. Select the check box before the desired file.
5. Tap .
6. Tap **Bluetooth**, and then select **Always** or **Just once**.
7. If the Bluetooth is deactivated, it will prompt you to tap **Turn on** to activate the Bluetooth mode.
The phone scans and displays the available Bluetooth device automatically.
If there is no Bluetooth device found, go to  > **Refresh** to search for the Bluetooth devices.
8. Tap the desired Bluetooth device to share the pictures/videos/audio.
The phone screen will prompt "Sending n file to "XXX"" (n represents the number of the files that are being sent).
9. Accept the request of transferring files via Bluetooth on the Bluetooth device.
If the pictures are successfully transferred, the notification center will display a notification "Bluetooth share: Sent files n successful, n unsuccessful." (n represents the number of files that are sent successfully or unsuccessfully).

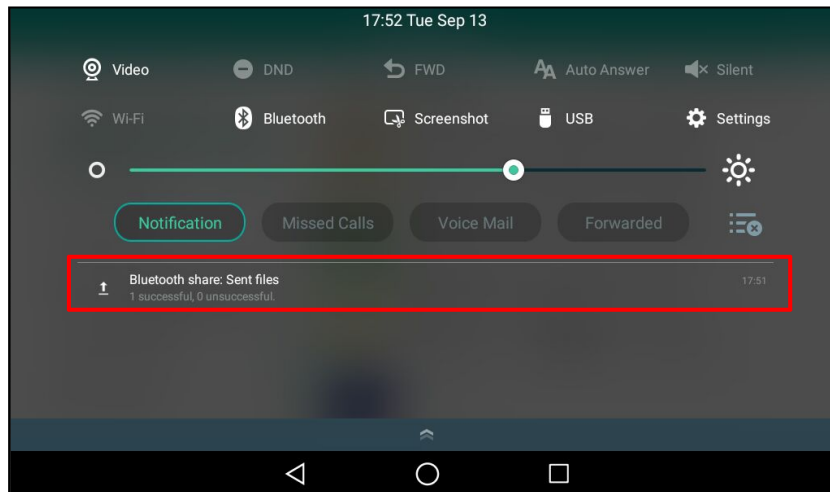

You can tap the notification to view the detail information about the shared files.



Sharing Pictures/Videos/Audio via Email

You can share files in the **File Manager** via email on your phone.

Before You Begin

Make sure you have signed in an email account.

Procedure

1. Swipe left or right to go to the second idle screen.
2. Tap  to launch **File Manager**.
3. Tap **Photos/Videos/Audios** in **Local Storage** field.
If a USB flash drive has been connected to your phone, you can tap **Photos/Videos/Audios** in the **USB Storage** field to view the files stored in USB flash drive.
4. Select the check box before the desired file.
5. Tap  .
6. Tap **Email**, and then select **Always** or **Just once**.
7. Compose the email.
8. Enter the email account you want to send the email to in the **To** field.
9. (Optional.) Enter the email subject in the **Subject** field.

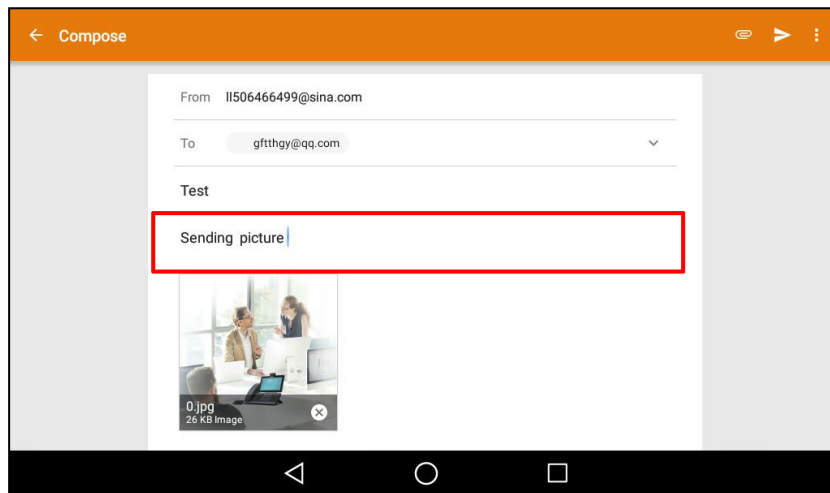

10. Tap  to send the email.

The pictures/videos/audio are transferred as a mail attachment.

Note: The attachment size must be within 5MB.

Related Topic

[Signing in Email](#)

Gallery

You can access the **Gallery** to do many operations for the listed pictures/videos. You can also take pictures/videos with it.



Topics

[Viewing Pictures/Videos](#)
[Editing Pictures](#)
[Setting a Picture as Wallpaper](#)
[Printing Pictures](#)
[Deleting Pictures/Videos](#)
[Taking a Picture/Video](#)
[Sharing Pictures/Videos via Bluetooth](#)
[Sharing Pictures/Videos via Email](#)

Viewing Pictures/Videos



You can view the pictures/videos on your phone in different ways.

Procedure

1. Swipe left or right to go to the second idle screen.
2. Tap  () to launch the **Gallery**.

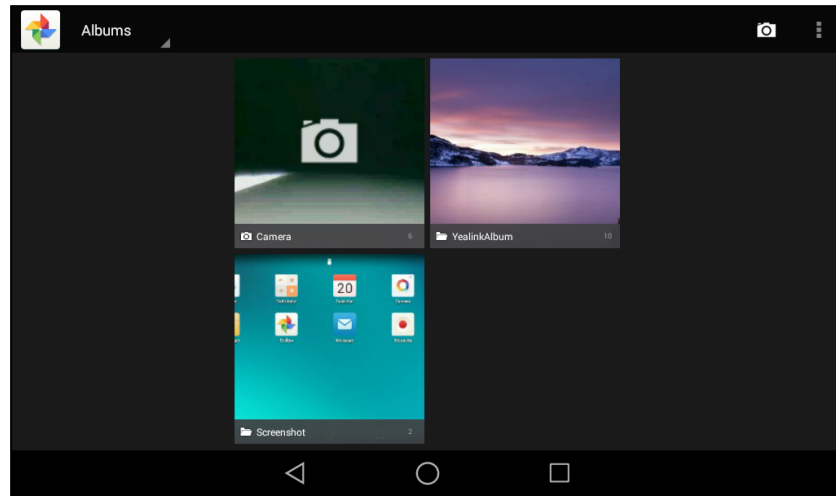
By default, the pictures/videos are displayed as thumbnails in the albums arrangement mode.



3. (Optional.) Tap **Albums**.
You can tap **Albums/Locations/Times/People/Tags** to view the pictures/videos in different arrangement modes.
4. Swipe left/right to view all albums if required.
5. Select the desired album.
6. You can do the following:
 - Tap the album name on top-left of the phone screen.
Select **Filmstrip view** or **Grid view** to view the pictures/videos in different modes.
 - Tap  , and then tap **Group by**.
Select a desired group type in the pop-up dialog box to view the pictures/videos in different arrangement modes.
7. Tap a desired picture/video to preview the picture/video.
8. For picture albums, you can tap  > **Slideshow** to start a slide show of the pictures in the album.

Note

The menu keys and Android keys will disappear after 5 seconds, you may tap the phone screen to show them again.

You can also select a desired picture/video and tap  > **Details** to view the detailed information.

Editing Pictures

You can edit the pictures in the **Gallery**.

Topics

[Rotating Pictures](#)

[Adding a Filter for Pictures](#)

[Adding a Frame for Pictures](#)



[Cropping Pictures](#)

[Coloring Pictures](#)

Rotating Pictures

You can rotate the picture as you want.





Procedure

1. Swipe left or right to go to the second idle screen.
2. Tap  () to launch the **Gallery**.
3. Tap the desired picture album.
4. Tap the desired picture.
5. Tap  > **Rotate left/Rotate right** to rotate the picture left/right
6. Tap **SAVE**.

Adding a Filter for Pictures

You can add a filter for the picture to change its display style.

Procedure

1. Swipe left or right to go to the second idle screen.
2. Tap  () to launch the **Gallery**.
3. Tap the desired picture album.
4. Tap the desired picture.
5. Go to  > **Edit** >  .
6. Select the desired filter.
7. Tap **SAVE**.

Adding a Frame for Pictures

You can add a frame for the picture to make it displayed more vivid.





Procedure

1. Swipe left or right to go to the second idle screen.
2. Tap  () to launch the **Gallery**.
3. Tap the desired picture album.
4. Tap the desired picture.
5. Go to  > **Edit** >  .
6. Select the desired frame.
7. Tap **SAVE**.

Cropping Pictures

You can crop a picture to the desired size.

Procedure

1. Swipe left or right to go to the second idle screen.
2. Tap  () to launch the **Gallery**.
3. Tap the desired picture album.
4. Tap the desired picture.
5. Go to  > **Edit** >  .
6. Do the following:
 - Tap **Crop** to resize the picture.
 - Tap **Straighten** to straighten the picture.
 - Tap **Rotate** to rotate the picture clockwise.





- Tap **Mirror** to flip the picture symmetrically.
- Tap **Draw** to draw the picture.

7. Tap **SAVE**.

Coloring Pictures

You can color pictures to make the pictures displayed better.



Procedure

1. Swipe left or right to go to the second idle screen.
2. Tap  () to launch the **Gallery**.
3. Tap the desired picture.
4. Go to  > **Edit** > .
5. Adjust the desired exposure, contrast, saturation and so on.
6. Tap **SAVE**.

Setting a Picture as Wallpaper

You can set a desired picture as wallpaper to make your phone more personalized.

Procedure

1. Swipe left or right to go to the second idle screen.
2. Tap  () to launch the **Gallery**.
3. Tap the desired picture album.
4. Tap the desired picture.
5. Go to  > **Set picture as**.
6. Do one of the following:
 - If you want to set the picture as phone wallpaper, tap **Wallpaper**, and then tap **Set wallpaper** on the top-right of the screen.
 - If you connect EXP50 to your phone, tap **Exp Background**, and then tap **Set as exp background** on the top-right of the screen.



Printing Pictures

You can print the desired pictures in the **Gallery**.

Before You Begin

Before printing the picture, make sure your phone has been connected to the network printer. For more information, refer to the documentation from the printer manufacturer.



Procedure

1. Swipe left or right to go to the second idle screen.
2. Tap  () to launch the **Gallery**.
3. Tap the desired picture album.
4. Tap the desired picture.
5. Go to  > **Print** to print the picture.

Deleting Pictures/Videos

You can delete any useless picture/video from the **Gallery**.

Procedure

1. Swipe left or right to go to the second idle screen.
2. Tap  () to launch the **Gallery**.
3. Tap the desired album.
4. Do one of the following:
 - Long tap the desired picture/video.
 - Go to  > **Select item**.
 Select the pictures/videos you want to delete.

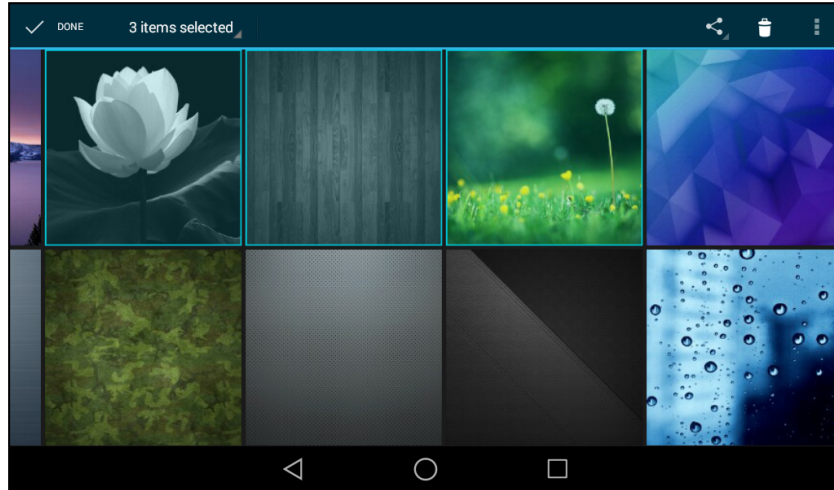

You can also tap **n items selected** (n represents the number of pictures you selected) and then tap **Select all** to select all pictures.

5. Tap  to delete the selected pictures/videos.
The phone prompts you whether to delete the pictures/videos.
6. Tap **OK**.









Taking a Picture/Video

You can take a picture/video with the **Gallery** directly.

Before You Begin

Make sure you have inserted the camera to the phone.

Procedure

1. Swipe left or right to go to the second idle screen.
2. Tap  () to launch the **Gallery**.
3. Tap  on the top-right of the screen.
4. (Optional.) Tap , and then do the following:
 - Tap  to turn on the camera grid.
 - Tap  to configure the camera timer.
5. Swipe right, and then select **Camera** or **Video**
6. Tap  to take a picture or tap  to take video.



Sharing Pictures/Videos via Bluetooth

You can share the pictures/videos in the **Gallery** via Bluetooth.

Before You Begin



Before sharing pictures/videos via Bluetooth, make sure the Bluetooth device is discoverable.

Procedure

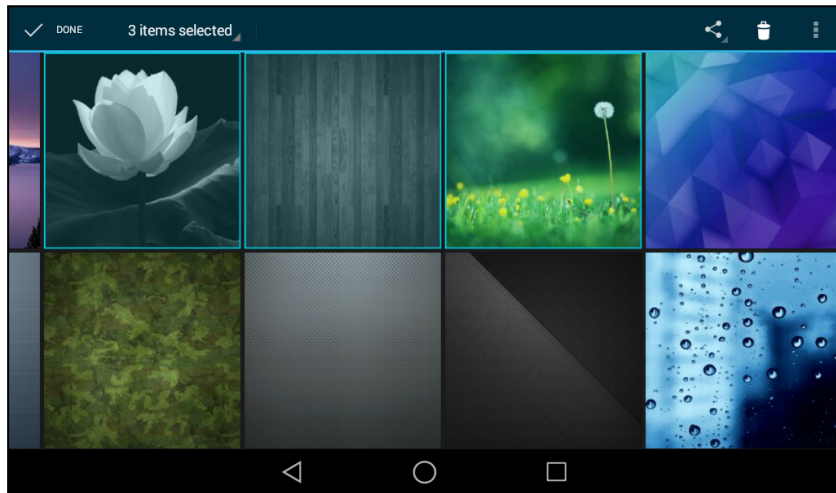
1. Swipe left or right to go to the second idle screen.
2. Tap  () to launch the **Gallery**.
3. Tap the desired picture album.
4. Do one of the following:
 - Long tap one of the pictures/videos.
 - Tap  > **Select item**.
 Select the pictures/videos you want to share.



You can also tap **n items selected** (n represents the number of pictures/videos you selected) and then tap **Select all** to select all pictures/videos.

5. Tap , and then select **Bluetooth**.
6. If the Bluetooth is deactivated, it will prompt you to tap **Turn on** to activate the Bluetooth mode.
The phone scans and displays the available Bluetooth device automatically.
 If there is no Bluetooth device found, go to  > **Refresh** to search for the Bluetooth devices.
7. Tap the desired Bluetooth device to share the pictures/videos.
The phone screen will prompt "Sending n file to "XXX"" (n represents the number of pictures/videos that are being sent).
8. Accept the request of transferring files via Bluetooth on the Bluetooth device.
If the pictures/videos are successfully transferred, the notification center will display a notification "Bluetooth share: Sent files n successful, n unsuccessful." (n represents the number of files that are sent successfully or unsuccessfully).

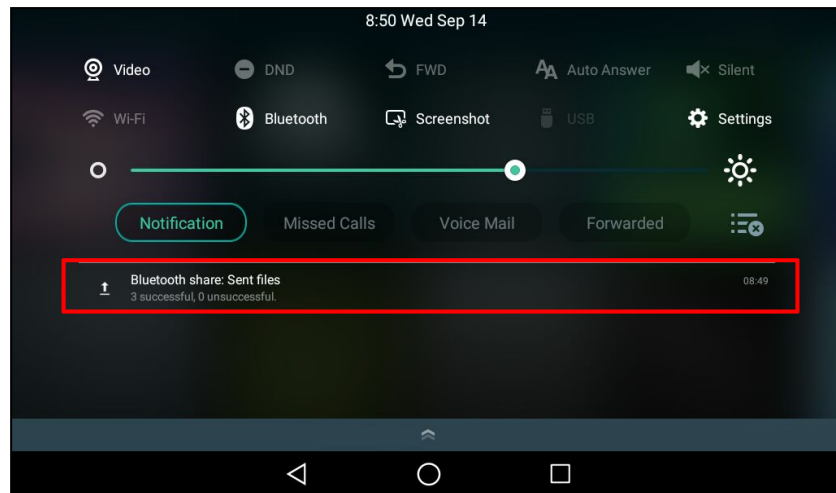

You can tap the notification to view the detail information about the shared files.



Sharing Pictures/Videos via Email

You can share the pictures/videos in the **Gallery** via Email.

Before You Begin

Make sure you have signed in an email account.

Procedure

1. Swipe left or right to go to the second idle screen.
2. Tap  () to launch the **Gallery**.
3. Tap the desired album.
4. Do one of the following:
 - Long tap one of the pictures/videos.
 - Tap  and then tap **Select item**.
 Select the pictures/videos you want to share.

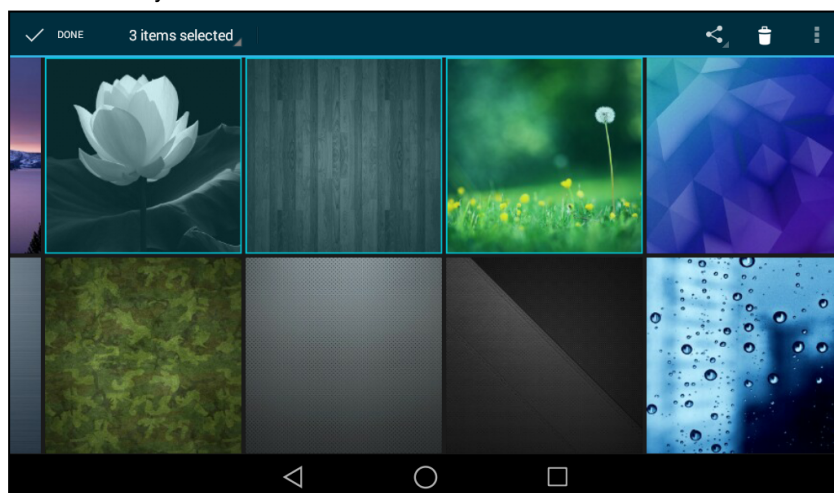

You can also tap **n items selected** (n represents the number of pictures/videos you selected) and then tap **Select all** to select all pictures/videos.

5. Tap  and then select **Email**.
6. Compose the email.

7. Enter the email account you want to send the email to in the **To** field.
8. (Optional.) Enter the email subject in the **Subject** field.

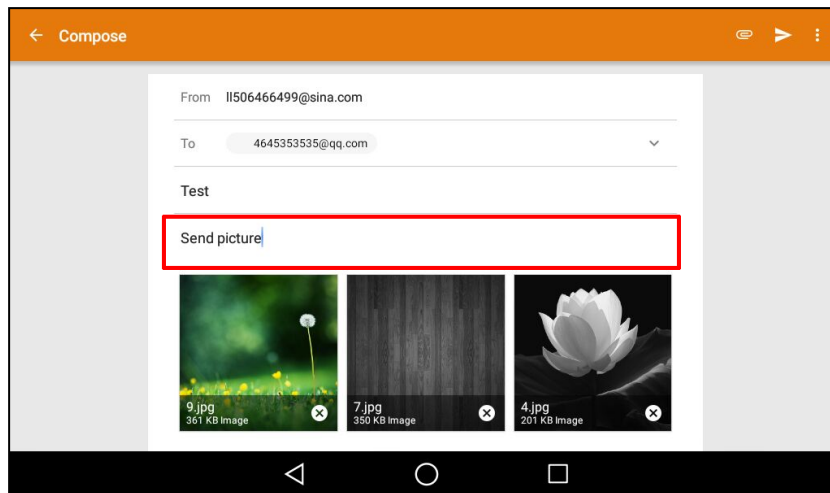

9. Tap  to send the email.

The pictures/videos are transferred as a mail attachment.

Note: The attachment files size must be within 5MB.

Related Topic

[Signing in Email](#)

Recorder

You can use the **Recorder** to record audio and manage the recording.

During recording, you can mark specific moments so that you can quickly find and listen to them later. You can record up to 12 hours in one file. The recording is saved in "*.amr" format with the name consisting of a prefix "record@" and date & time stamp.

Topics







- [Recording Audio](#)
- [Playing a Recorded Call](#)
- [Pause/Resuming a Playback](#)
- [Fast Forwarding/Rewinding a Playback](#)
- [Stopping a Playback](#)
- [Renaming the Recording](#)
- [Uploading a Recording to Server](#)
- [Deleting a Recording](#)
- [Deleting All Recordings](#)
- [Checking Storage Space](#)

Recording Audio

By default, the recorded audio is saved in the internal SD card. You can connect a USB flash drive to your phone, the recorded audio will be saved in the USB flash drive instead of the internal SD card.

Note: For more information on how to attach a USB flash drive, please refer to the Quick Start Guide for your phone on [Yealink Support](#).

Procedure

1. Swipe left or right to go to the second idle screen.
2. Tap  to launch the **Recorder**.
3. Tap  to start recording.
4. Do one of the following:
 - Tap  to pause the recording.
 - Tap  to set a mark.
The icon changes to , the number will increase if you set more marks.
And there is a red flag on this moment when playing.
5. Tap  to end the recording and save the recording.
The recorded audio will be displayed on the right list automatically.



Playing a Recorded Call

You can browse and play back the recordings on your phone.

The recorded calls include a date & time stamp and the other party's number/IP address/name (or the first person's number/IP address/name you called), for example, 20160302-1452-Tom was created on March 2, 2016, at 14:52 and you have a call with Tom. The recorded audio-only calls are saved in ".aac" format and the recorded video calls are saved in ".mkv" format. You can view the recorded files by **Recorder** or **File Manager**. The following is an example of playing the recorded call using the **Recorder**.

Tip: You can also play back the recorded calls on the phone or on a computer using an application compatible of playing ".aac"/".mkv" files.



Procedure

1. Swipe left or right to go to the second idle screen.
2. Tap  to launch the **Recorder**.
3. Tap  before the desired recorded call to play the recorded call.
The length of the recording and a progress bar are displayed as the recording plays.
 You can press the Volume key  to adjust the volume of audio output.

Pause/Resuming a Playback

When you receive an incoming call while playing a recording, the recording is paused automatically. You can resume the playback after handling the call. You can also pause the recording manually at any time.

Procedure

1. Tap  to pause playing the recording. The icon  appears on the phone screen.
2. Tap  to resume the playback.

Fast Forwarding/Rewinding a Playback

While a recorded file plays, you can fast forward or rewind the playback at any time.

Procedure

1. Drag the slider to skip forward the playing or rewind the playing.
 If you have set marks for the recorded audio, you can drag the slider to the position with a red flag to listen to the marked moments.

Stopping a Playback

While a recording plays, you can stop playing it at any time.



Procedure

1. Tap  to stop the playing.

Renaming the Recording

You can rename the recording for better recognition.

Procedure

1. Swipe left or right to go to the second idle screen.
2. Tap  to launch the **Recorder**.
3. Tap  after the desired recording.
4. Tap **Rename**.
5. Enter the desired file name.
6. Tap **OK**.



Uploading a Recording to Server

You can upload the local recording file to the server designated by the administrator.

Before You Begin

Your system administrator has enabled the recording upload feature for you.

Procedure



1. Swipe left or right to go to the second idle screen.
2. Tap  to launch the **Recorder**.
3. Tap  after the desired recorded audio.
4. Tap **Upload**.

The file is uploaded to the server successfully with a prompt.

Deleting a Recording

You can delete local recordings or call recordings from **Recorder**. The local recording is named with a prefix “record@” and date & time stamp, while the call recordings are named with the date & time stamp.

Procedure

1. Swipe left or right to go to the second idle screen.
2. Tap  to launch the **Recorder**.
3. Tap  after the desired recorded audio.
4. Tap **Delete**.

The phone prompts you whether to delete the audio.

5. Tap **OK**.

Deleting All Recordings

You can delete all the recording when you need additional space.

Procedure

1. Swipe left or right to go to the second idle screen.
2. Tap  to launch the **Recorder**.

3. Tap  .
The phone prompts you whether to delete all the audio files.
4. Tap **OK**.

Checking Storage Space

You can check the total space or available space of the phone or connected USB flash drive.

Procedure

1. Swipe left or right to go to the second idle screen.
2. Go to **Settings > Status > Storage**.

Camera

The phone supports taking pictures and recording videos via **Camera**.

The pictures/videos taken by the camera are saved in ".jpg"/".mp4" format with the name consisting of a prefix "IMG/VID" and date & time stamp in the internal SD card. You can view the pictures/videos in the **File Manager**.

Topics

- [Inserting the USB Camera to the Phone](#)
- [Taking Pictures](#)
- [Recording Videos](#)
- [Camera Settings](#)

Inserting the USB Camera to the Phone

Before using the camera, you should insert the USB camera to the phone.

The following introduces how to insert the camera to the T58A phone.

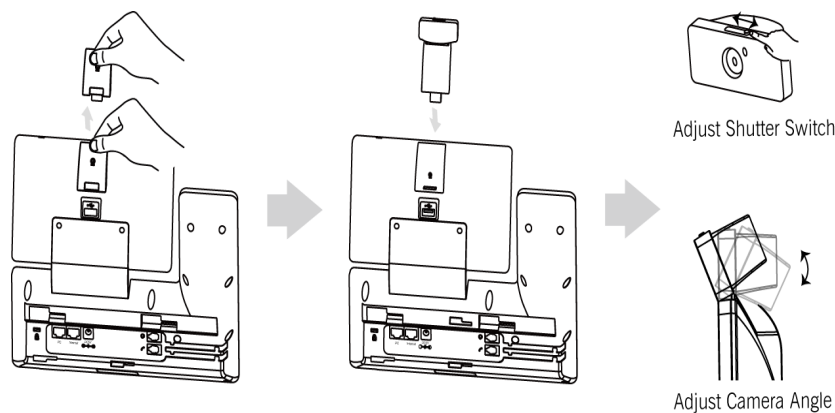

Note: The phone only supports the Yealink original USB camera. You should purchase it separately for T58A/T58W/T58W Pro smart media phone.







Taking Pictures

You can easily take pictures with the **Camera** when the phone is in the idle screen.

Before You Begin

Make sure you have inserted the camera to the phone.

Procedure

1. Swipe left or right to go to the second idle screen.
2. Tap  () to launch the **Camera**.
3. (Optional.) Tap , and then do the following:
 - Tap  to turn on the camera grid.
 - Tap  to configure the camera timer.
4. Tap  to take a picture.

You can swipe left to view all pictures or videos taken by the camera.









Recording Videos

You can easily record videos with the **Camera** when the phone is in the idle screen.

Before You Begin

Make sure you have inserted the camera to the phone.

Procedure



1. Swipe left or right to go to the second idle screen.
2. Tap  () to launch the **Camera**.
3. Swipe right, and then select **Video**.
4. (Optional.) Tap  >  to turn on the camera grid.
5. (Optional.) Tap  >  to set the time delay.
6. Tap  to start recording.
The recording time will appear on the left-top of the phone screen.
7. Tap  to stop recording.

You can swipe left to view all videos taken by the camera.

Camera Settings

After you insert the USB camera to the phone, you can set the camera to get a better photo effect.

Procedure

1. Swipe left or right to go to the second idle screen.
2. Tap  () to launch the **Camera**.
3. Swipe right, and tap  on the right-top of the phone screen.
4. You can do the following:
 - Tap **Resolution & quality** to configure the resolution of the camera.
 - Tap **Advanced** to configure whether to use manual exposure.

Email

You can use the **Email** to access personal or business email account, and send/receive emails.

Topics



- [Signing in Email](#)
- [Sending Emails](#)
- [Reading Emails](#)
- [Deleting Emails](#)
- [Marking/Printing Email](#)

[Adding Multiple Email Accounts](#)
[Using Email Widget](#)
[Sending Files via Email](#)

Signing in Email

When launching the **Email** for the first time, a wizard will be provided for you to set up the email account step by step.





Procedure

1. Do one of the following:
 - Swipe left or right to go to the second idle screen.
Tap  () to launch **Email**.
 - Swipe left or right to go to the third idle screen.
Tap the email widget.
2. Sign in email according to the setup wizard.

Sending Emails

You can easily send emails on your phone.



Procedure

1. Swipe left or right to go to the second idle screen.
2. Tap  () to launch **Email**.
3. Tap .
4. Compose the email.
5. Enter the email account you want to send the email to in the **To** field.
6. (Optional.) Enter the email subject in the **Subject** field.
7. (Optional.) Tap  and then tap **Attach file** to add a file as a mail attachment.
The attachment size must be within 5MB.
8. Tap  to send the email.

Reading Emails

If there is an incoming email, the phone will play a warning tone, and a notification will be on the notification center. You can tap the notification to read the email.



Procedure

1. Swipe left or right to go to the second idle screen.
2. Tap  () to launch **Email**.
If the email you want to read is not in the inbox, you can tap  on the top-left of the phone screen to select the folder that contains the email you want to read.
3. Tap the desired email to read.

Deleting Emails

You can delete the useless emails from **Email**.

Procedure

1. Swipe left or right to go to the second idle screen.
2. Tap  () to launch **Email**.

If the email you want to delete is not in the inbox, you can tap  on the top-left of the phone screen to select the folder that contains the email you want to delete.

3. Long tap the desired email.

4. Tap .

Marking/Printing Email

You can mark, print and star the email.





Procedure

1. Swipe left or right to go to the second idle screen.

2. Tap  () to launch **Email**.

If the email you want to configure is not in the inbox, you can tap  on the top-left of the phone screen to select the folder that contains the email you want to configure.

3. You can do the following:

- Tap  /  to mark the email as unread/read.
- Tap  > **Print** to print the email.
- Long tap the desired email.
Tap  > **Add star** to star the email.

Adding Multiple Email Accounts

You can add more than one email account on the phone.

Procedure

1. Swipe left or right to go to the second idle screen.

2. Tap  () to launch **Email**.

3. Tap  on the top-left of the phone screen.

4. Go to **Settings > Add account**.

5. Add the account according to the setup wizard.

Once another email account is successfully added, the phone screen will display as below:

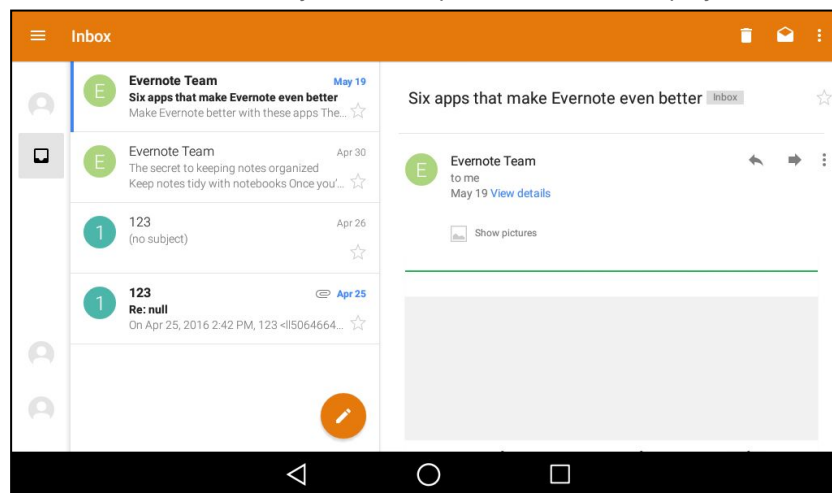

You can tap  on the bottom-left of the phone screen to switch between the email accounts.

Related Topic

[Adding APP Accounts](#)

Using Email Widget

After you sign in the email, you can choose the desired folder to display on the widget.

If you add an email widget to display the unread emails, and you want the widget to display the incoming emails, you should add a new widget.

Procedure

1. Swipe left or right to go to the third idle screen.
2. Tap the email widget.
3. Tap the desired account, if you have more than one email account.
4. Tap the desired folder to display on the widget.

If you select **Inbox**, the email widget will display as below:

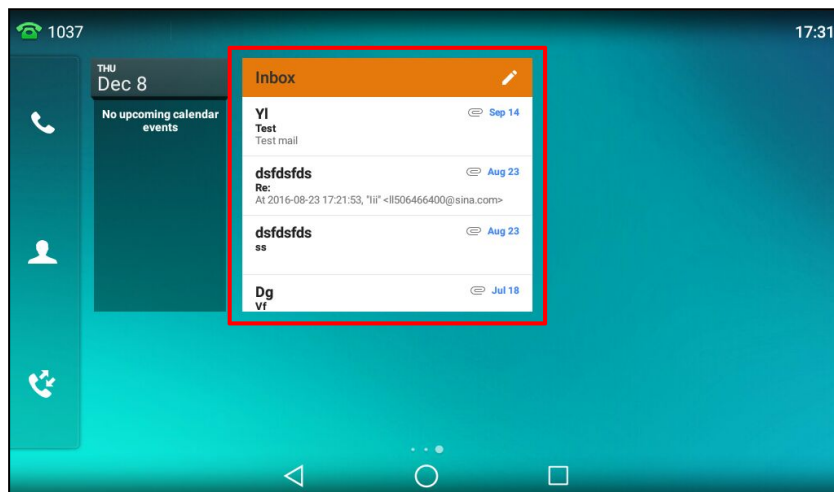

You can drag up and down to scroll through emails in inbox folder, and tap the desired email to view. You can also tap  on the top-right of the widget to compose and send an email.

Related Topic

[Adding APP Accounts](#)

Sending Files via Email

The **Gallery** and **File Manager** support data transfer via Email. You can send pictures, audio or videos as mail attachments to another account.

Related Topic

[Sharing Pictures/Videos/Audio via Email](#)

[Sharing Pictures/Videos via Email](#)

Browser

The use of **Browser** is similar to PC's web browser, which allows you to browse web pages, set bookmarks, set home pages, clear history records, and so on.

Topics

[Browsing a Web Page](#)

[Managing Bookmarks](#)

[Setting a Home Page](#)

[Clearing the Navigation History](#)

[Modifying the Browser Settings](#)

Browsing a Web Page

You can use the **Browser** just like normal browsers to browse websites.

Procedure

1. Swipe left or right to go to the second idle screen.
2. Tap  () to launch the **Browser**.
3. Enter a part of URL in the address input field of the browser.
The phone will automatically retrieve and list similar websites.
4. Tap the website you want to visit, or enter the full URL then tap **Go** on the onscreen keyboard to browse the web page.

Managing Bookmarks

You can bookmark the web pages that you frequently visit.

Topics

[Adding a Web Page to the Bookmarks Library](#)

[Accessing a Web Page from the Bookmarks Library](#)



[Editing a Bookmark](#)

[Deleting a Bookmark](#)

Adding a Web Page to the Bookmarks Library

You can bookmark a web page so you can access it from the Bookmarks Library directly.

Procedure



1. Swipe left or right to go to the second idle screen.
2. Tap  () to launch the **Browser**.
3. Access the web page you want to bookmark.
4. Tap .
5. Edit the details of your bookmark.
6. Tap **OK**.

*The web page is added to the **BOOKMARKS** Library.*

Accessing a Web Page from the Bookmarks Library

You can quickly visit the web page from the Bookmarks Library.

Procedure

1. Swipe left or right to go to the second idle screen.
2. Tap  () to launch the **Browser**.
3. Tap  to access the **BOOKMARKS** list.

A list of web pages that you've bookmarked will appear.

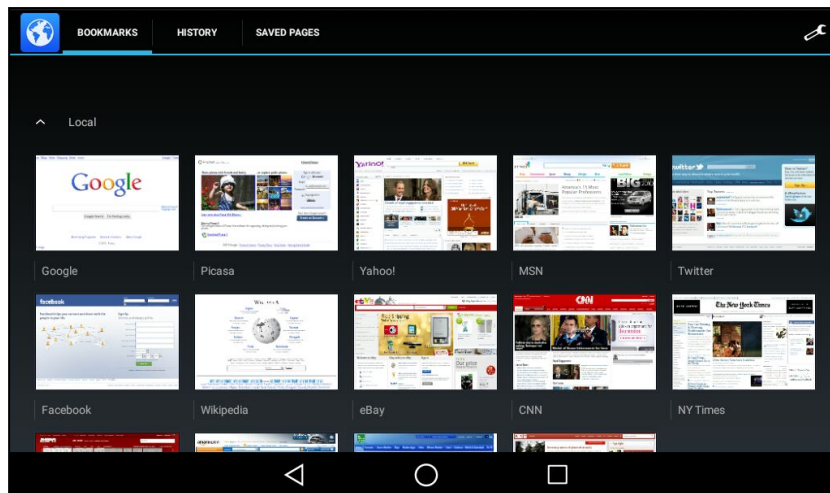



4. Tap the web page you want to visit.

Editing a Bookmark

You can edit the details of your bookmark for better recognition.

Procedure

1. Swipe left or right to go to the second idle screen.
2. Tap  () to launch the **Browser**.
3. Tap  to access the **BOOKMARKS** list.
A list of web pages that you've bookmarked will appear.
4. Long tap the bookmark you want to edit.
5. Tap **Edit bookmark** in the pop-up dialog box.
6. Edit the bookmark.

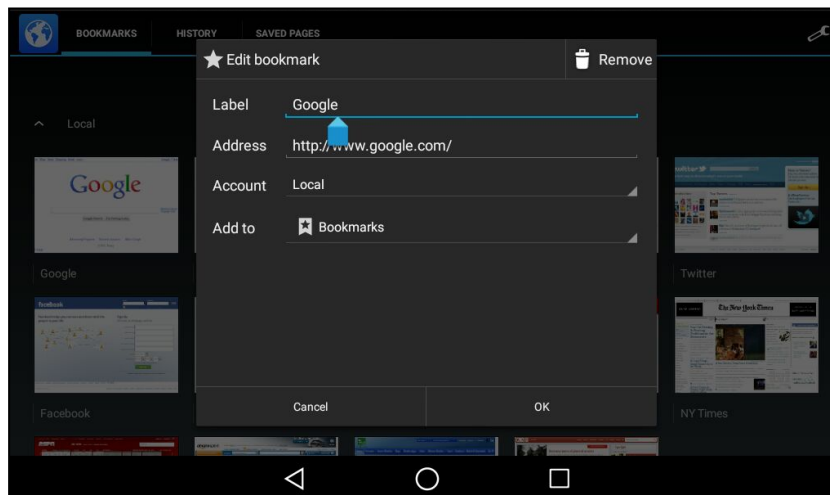



7. Tap **OK**.

Deleting a Bookmark

When you do not need the bookmark any more, you can delete it.



Procedure

1. Swipe left or right to go to the second idle screen.
2. Tap  () to launch the **Browser**.
3. Tap  to access the **BOOKMARKS** list.
All pre-configured bookmarks are in the list.
4. Long tap the bookmark you want to delete.
5. Tap **Delete bookmark** in the pop-up dialog box.
6. Tap **OK**.

Setting a Home Page

You can set the web page you visit most frequently as the home page. This web page opens automatically each time you open the browser.

Procedure



1. Swipe left or right to go to the second idle screen.
2. Tap  () to launch the **Browser**.
3. Tap  > **Settings** > **General** > **Set homepage**.
4. Tap the web page you want to set as the home page in the pop-up dialog box.

Tip: You can also long tap a web page in **BOOKMARKS** list and then tap **Set as homepage**.

Clearing the Navigation History

You can periodically clear your navigation history to protect your privacy and prevent information disclosure.



Procedure

1. Swipe left or right to go to the second idle screen.
2. Tap  () to launch the **Browser**.
3. Go to  > **Settings** > **Privacy & security** > **Clear history**.
The phone screen prompts you to delete the browser navigation history or not.
4. Tap **OK**.

Modifying the Browser Settings

You can modify the browser settings to customize your **Browser**.

Procedure

1. Swipe left or right to go to the second idle screen.
2. Tap  () to launch the **Browser**.
3. Tap  > **Settings**.
4. Customize the browser style you prefer.

Calendar

You can use the **Calendar** to synchronize events from email account as well as create, modify and view the events.

Topics

[Signing Into Calendar](#)

[Creating an Event](#)



[Checking Events](#)

[Modifying the Calendar Settings](#)

Signing Into Calendar

Before creating an event, you should sign into the calendar with an email account first. If you have registered an account on the **Email** already, you can skip this step.

Procedure

1. Swipe left or right to go to the second idle screen.
2. Tap  () to launch **Calendar**.
3. Tap  .

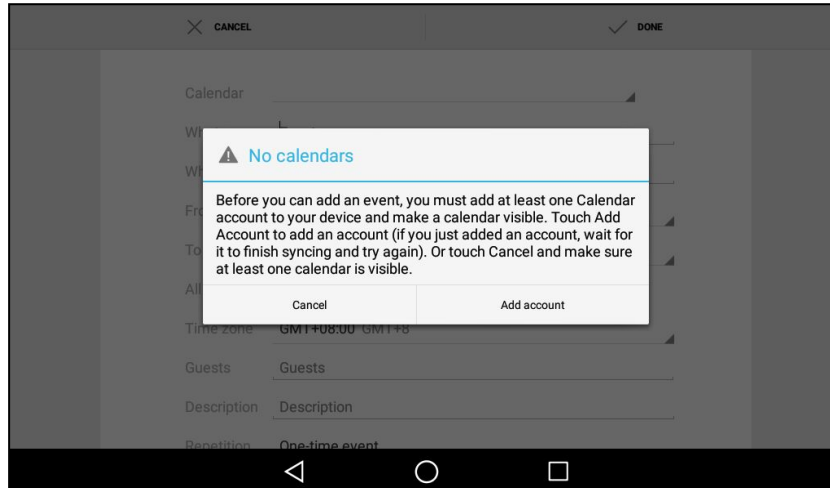



4. Tap **Add account**.
5. Sign into the Calendar according to the setup wizard.

Creating an Event

You can create an event in the **Calendar** to remind you of the important issues.

Procedure

1. Swipe left or right to go to the second idle screen.
2. Tap  () to launch the **Calendar**.
3. Select the desired date.
4. Tap  .

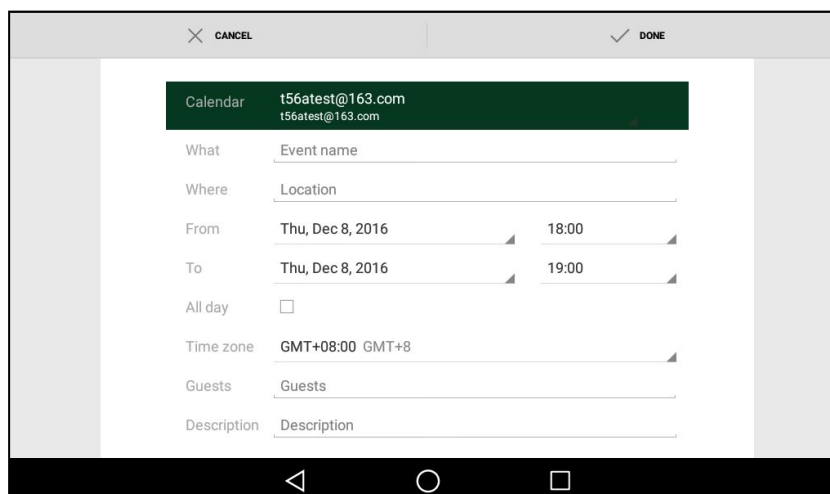



- 5. Edit the event.
- 6. Tap **DONE**.

Checking Events

On the calendar, you can check the information about an event you have added.

Procedure

- 1. Swipe left or right to go to the second idle screen.
- 2. Tap  () to launch the **Calendar**.
- 3. (Optional.) Tap the current date (for example, **December 2016**) displayed on the top-left of the phone screen.

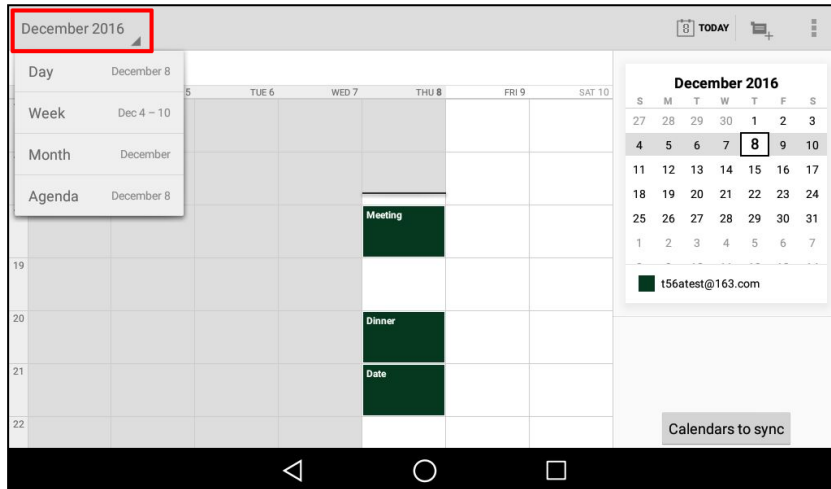

Tap **Day/Week/Month/Agenda** to select the time.

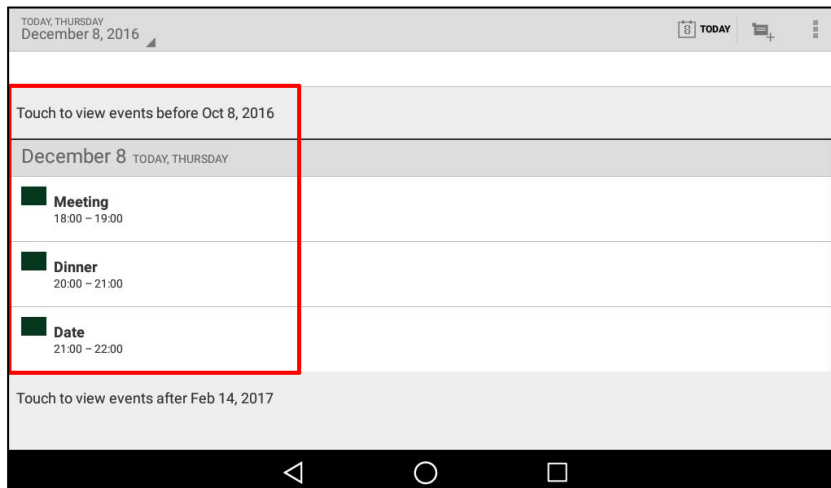

In the agenda view, the events you have added are displayed as a list. You can tap **Touch to view events before XXX/Touch to view events after XXX** to view all events.



Modifying the Calendar Settings

You can modify the calendar settings to customize the **Calendar**.



Procedure

1. Swipe left or right to go to the second idle screen.
2. Tap  () to launch the **Calendar**.
3. Go to  > **Settings**.
4. Customize the general settings and account settings.

Calculator

You can use the **Calculator** to perform simple or complex calculations.

Procedure

1. Swipe left or right to go to the second idle screen.
2. Tap  () to launch the **Calculator**.

Clock

You can use the **Clock** to set an alarm, check the time of other cities in the world, set a stopwatch and timer.

Topics

[Alarm](#)

[Clock](#)

[Setting a Timer](#)

[Setting a Stopwatch](#)

Alarm

You can set an alarm on the phone to remind you of a task, for example, join a meeting.

Topics

[Setting an Alarm Clock](#)

[Editing an Alarm Clock](#)



[Deleting an Alarm Clock](#)

[Setting the Alarm Parameters](#)

Setting an Alarm Clock

To avoid forgetting the important tasks, you can set an alarm clock.

Procedure

1. Tap the digital clock widget on the home screen.
2. Tap  on the top-left of the phone screen.
3. Tap .
4. Tap the desired number to set the alarm time.
5. Tap **OK**.

The alarm clock you have set is displayed on the phone screen.

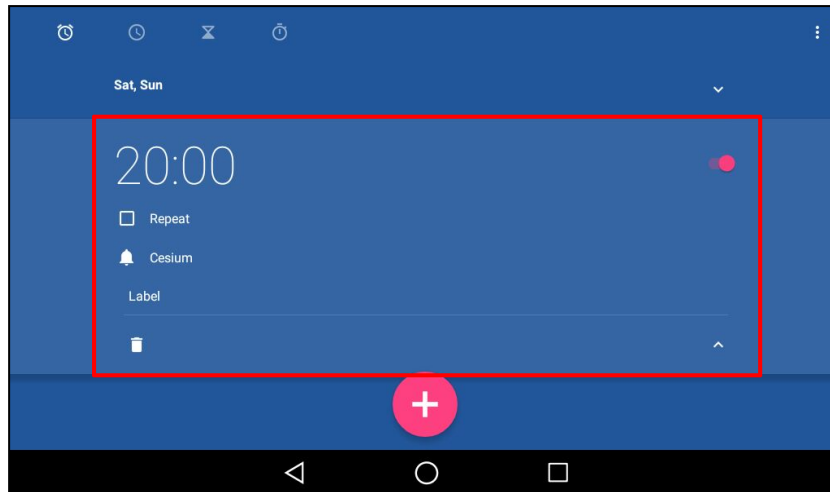

6. You can do the following:
- Select the **Repeat** check box, and then tap the repeat day of the alarm.
 - Tap .

Select a desired ring tone for the alarm, and then tap **OK**.
 - Tap the **Label** field.

Enter a label for the alarm, and then tap **OK**.

Note: If you have set the time format as **12 Hour**, you need to select **AM** or **PM** when setting the alarm time.

Editing an Alarm Clock

According to your needs, you can edit the alarm clocks.



Procedure

1. Tap the digital clock widget on the home screen.
2. Tap .
3. Drag up and down to select the desired alarm.
4. Tap the desired option to edit the alarm clock.

Deleting an Alarm Clock

When you no longer need the alarm clock, you can delete it.

Procedure





1. Tap the digital clock widget on the home screen.
2. Tap  on the top-left of the phone screen.
3. Tap the desired alarm.
4. Tap  on the bottom-left of the alarm to delete the desired alarm.

Setting the Alarm Parameters

You can set the alarm parameters to make your alarm clock more personalized.

Procedure

1. Tap the digital clock widget on the home screen.
2. Tap .

3. Tap  > **Settings**.
4. You can do the following:
 - Tap the desired lasting time of the alarm bell from the **Silence after** field.
The alarm clock will automatically stop after this specified period of time.
 - Tap the desired snooze time from the **Snooze length** field, and tap **OK**.
 - Tap the **Alarm volume** field, drag the slider to adjust the alarm volume and then tap **OK**.
 - Tap the **Volume buttons** field, and then configure the desired function for the Volume key when the alarm is ringing.
 - Snooze:** Press the Volume key  when the alarm is ringing, the alarm will stop and ring after a specified period of time.
 - Dismiss:** Press the Volume key  when the alarm is ringing, the alarm will stop.
 - Do nothing:** Press the Volume key  when the alarm is ringing, the alarm will still ring.

Clock

You can check the current time and date via the clock on the Home screen.

Topics



[Adding the Clock of Other Cities](#)

[Configuring the Clock Display Mode](#)

Adding the Clock of Other Cities

You can add the clock for other cities. After added, you can know the current time in multiple cities simultaneously.

Procedure

1. Tap the digital clock widget on the Home screen.
The phone screen displays the current date and time.
2. Tap .
3. Drag up and down to scroll through the cities.
4. Select the desired city check box.
5. Tap  to return to the clock screen.
The added clock of the desired city is displayed on the phone screen.

Configuring the Clock Display Mode

You can switch the digital clock to analog clock, set the home clock, and home time zone.



Procedure

1. Tap the digital clock widget on the Home screen.
2. Tap  > **Settings**.
3. You can do the following:
 - Select **Analog** from the **Style** field.
 - Select the **Automatic home clock** check box.
 - Select the desired time zone from the **Home time zone** field.

Setting a Timer



You can set a timer to keep you on track to finish something within a set time.

Procedure

1. Tap the digital clock widget on the home screen.
2. Tap .
3. Enter the time by tapping the digits on the right of the screen.
You can tap  to delete the entered numbers.

4. Tap .

When the timer is running, you can do the following:







- Tap  to add an additional minute.
- Tap  to pause the timer.
- Tap  to delete the current timer.

The timer beeps when the time is up. It keeps beeping until you tap to stop.

Setting a Stopwatch

You can set a stopwatch to measure the amount of time that you spend on something.

Procedure

1. Tap the digital clock widget on the home screen.
2. Tap .
3. Tap .
4. You can do the following:
 - Tap  to pause the stopwatch.
 - Tap  to reset the stopwatch.
 - Tap , and then tap Bluetooth or Email to share the record via Bluetooth or email.
 - Tap  to count a lap while the stopwatch is running.

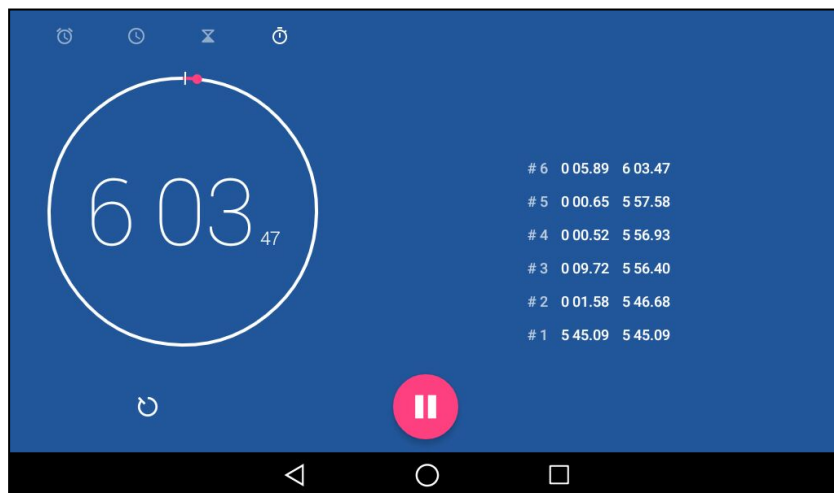

Related Topics

[Sending Files via Bluetooth](#)
[Sending Files via Email](#)

Customizing Your Phone

You can make your phone more personalized by customizing various settings.

Topics

[Changing the Administrator Password](#)
[Wallpaper](#)
[Screen Saver](#)
[Changing the Screen Backlight and Time](#)
[Changing the Language](#)
[Changing the Input Method](#)
[Time & Date](#)
[Setting a Key as Send](#)
[Phone Lock](#)
[Line Keys](#)

Changing the Administrator Password

By default, you require an administrator password to access the **Advanced/Advanced Settings** menu. The default password is “admin”. For security reasons, you should change the default password as soon as possible.

Note: If you do not change the default password, the phone displays a warning icon in the status bar.

Procedure

1. Swipe left or right to go to the second idle screen.
2. Go to **Settings > Advanced Settings > Set Password**.
3. Enter your old and new password information.
4. Select  .

Related Topic

[Investigating Warnings](#)

Wallpaper

You can change the background picture that is displayed on your phone.

The phone comes with a default background picture, you can change it to another built-in picture. You can also add personal pictures stored on a USB flash drive, or use a custom picture uploaded by your system administrator as the wallpaper.

Topics

[Changing Wallpaper on Idle Screen](#)
[Adding a Wallpaper from a USB Flash Drive](#)

Changing Wallpaper on Idle Screen

You can set one of your pictures as the background image on your phone's idle screen.

Procedure

1. Swipe left or right to go to the second idle screen.
2. Go to **Settings > Basic Settings > Display > Wallpaper**.

3. Select **Gallery** or **Wallpapers** and then select the desired image.

4. Select **Set wallpaper**.

Adding a Wallpaper from a USB Flash Drive

You can use a picture that is stored on a USB flash drive as the background image of your phone.

When USB flash drive is connected to your phone, the pictures on the USB flash drive are shown in the album. You can set a picture as wallpaper using the **Gallery** or **File Manager**.

We recommend that you add a picture that meets the size of the custom picture. Either the smaller or larger picture will be scaled proportionally to fit the screen.

Related Topic

[Setting a Picture as Wallpaper](#)

Screen Saver

The screen saver starts automatically when your phone has been idle for the preset waiting time. You can stop the screen saver by pressing any key.

Topics

[Changing the Waiting Time for Screen Saver](#)

[Setting the Screen Saver Type](#)

Changing the Waiting Time for Screen Saver

You can set the waiting time after no activity before displaying the screen saver.

Procedure





1. Swipe left or right to go to the second idle screen.
2. Go to **Settings** > **Basic Settings** > **Display** > **Screen Saver**.
3. Select the desired waiting time from the **Screensaver Waiting Time** field.
4. Select .

Setting the Screen Saver Type

The screen saver can start with different types and you can set it manually.

Your phone supports four screen saver types: **Clock**, **Colours**, **Photo Frame** and **Photo Table**.

Procedure

1. Swipe left or right to go to the second idle screen.
2. Go to **Settings** > **Basic Settings** > **Display** > **Screen Saver**.
3. Select the desired screen saver type.
 - If you select **Clock**, select  to select **Style** or **Night mode**.
 - If you select **Photo Frame**, select  to select the desired photo album(s).
 - If you select **Photo Table**, select  to select the desired photo album(s).
4. Select .

Changing the Screen Backlight and Time

You can change the brightness of the phone screen during phone activity and inactivity.

Active Level: The intensity of the phone screen when the phone is active.

Backlight Time: The delay time to change the brightness of the phone screen when the phone is inactive. Backlight time includes the following settings:

- **Always On:** Backlight is on permanently.
- **30min, 1h, 2h,4h, 6h, 8h or 12h:** Backlight is changed when the phone is inactive after the designated time.

Procedure

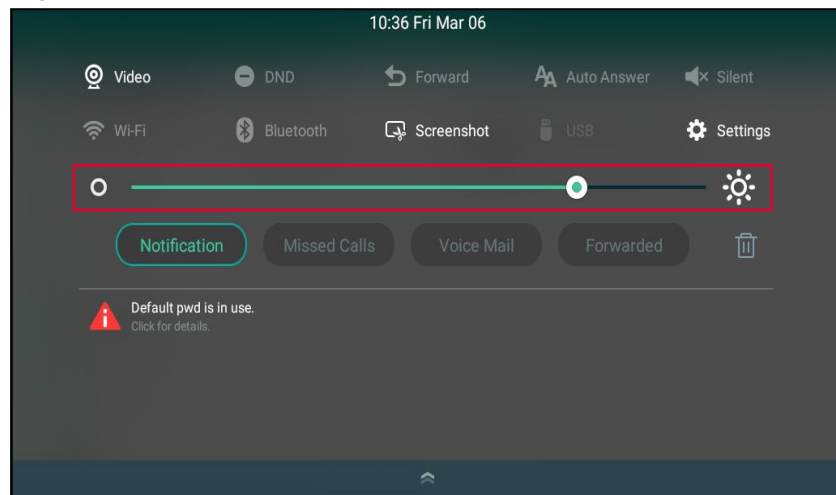

1. Swipe down from the top of the screen.
2. Do one of the following:
 - Drag the backlight slider.

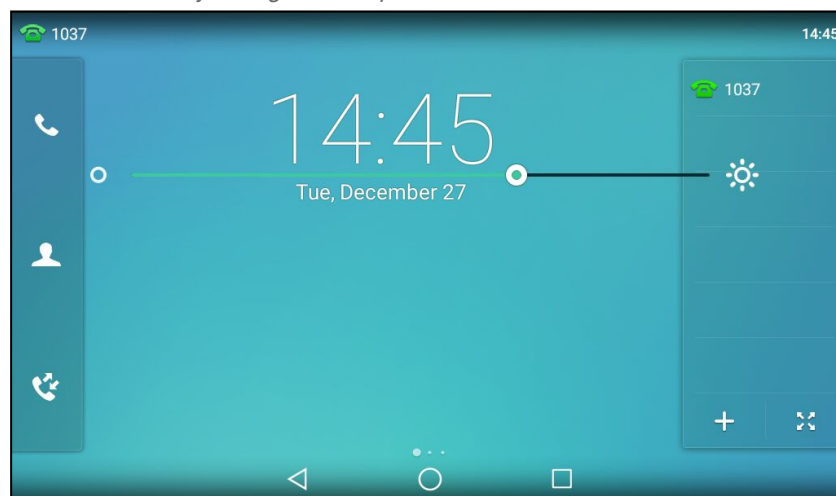

When dragging the slider, the control center (except the backlight slider) and notification center will be hidden. You can view the intensity changes of the phone screen in real-time.



If you lift your finger, the control center and notification center will be shown again.

- Tap  .
The intensity of the phone screen is changed to the highest.
- Tap  .
The intensity of the phone screen is changed to the lowest.

Tip: You can only change the screen intensity during phone activity on the control center. To change the backlight time, go to **Settings > Basic Settings > Display > Backlight**.

Changing the Language

Your phone supports several languages that you can choose to use on the phone.

Contact your system administrator to find out exactly which languages are supported on your phone.

Procedure

1. Swipe left or right to go to the second idle screen.
2. Go to **Settings > Basic Settings > Language & Input > Language**.
3. Select the desired language.
4. Select .

The phone language is changed to the selected one.

Changing the Input Method

The phone supports two kinds of input methods: English (UK) and 谷歌拼音输入法. The default input method is English (UK). You can change the currently used input method.

Procedure

1. Swipe left or right to go to the second idle screen.
2. Go to **Settings > Basic Settings > Language & Input > Current Input**.
3. Select the desired input method.

You can also long tap the following keys on the onscreen keyboard to change the input method.

For English (UK) input method:

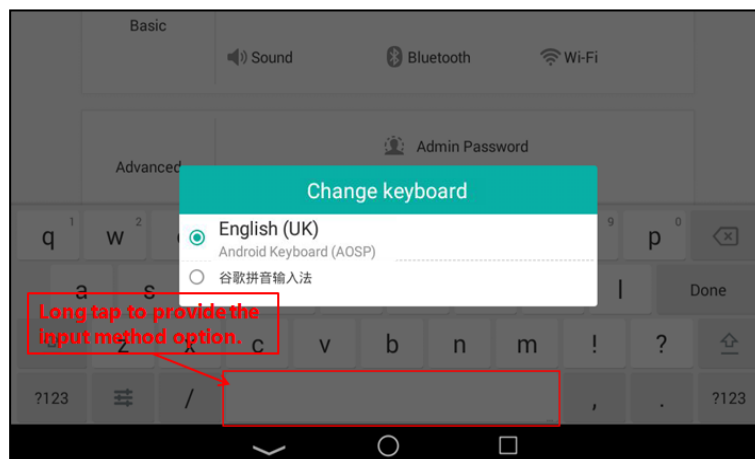

For 谷歌拼音输入法:

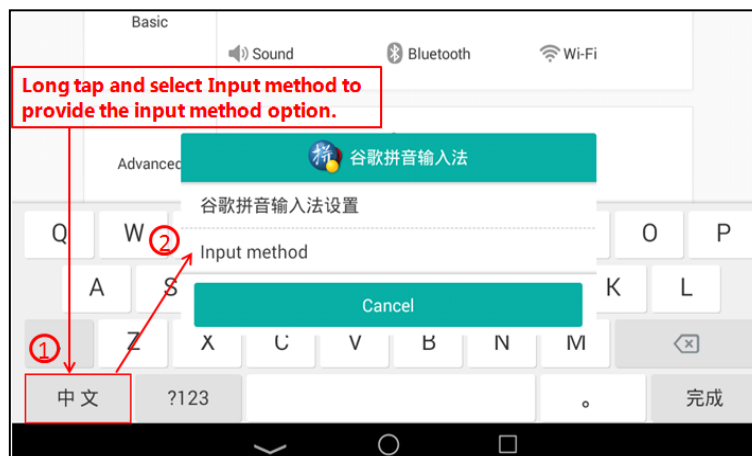

Time & Date

You can set the time and date manually. The time and date formats are also variable.

Topics

[Setting the Time and Date Manually](#)

[Changing the Time and Date Format](#)

Setting the Time and Date Manually

If your phone cannot obtain the time and date automatically, you can set it manually.

Procedure

1. Swipe left or right to go to the second idle screen.
2. Go to **Settings > Basic Settings > Time & Date > General**.
3. Edit the date and time.
4. Select .

The time and date set on the phone will be changed accordingly.

Note: After the phone reboots, it will be forcibly switched to obtain the time and date from the NTP server.

Changing the Time and Date Format

You can set the phone to display the time in 12-hour format or 24-hour format. You can also change the date format, including the options to display the day (D), month (M), and year (Y).

Note: Your system administrator can customize the date format.

Procedure

1. Swipe left or right to go to the second idle screen.
2. Go to **Settings > Basic Settings > Time & Date > Time & Date Format**.
3. Select the desired time format or date format.
4. Select .

Setting a Key as Send

The pound key (#) is used as the send key by default. To type a phone number followed by the pound key (#), you can set the send key to the star key (*).

You can also disable “#” and “*” to be used as the send key.

Procedure

1. Swipe left or right to go to the second idle screen.
2. Go to **Setting > Features > Key As Send**.
3. Select the desired value from the **Key As Send** field.
4. Select .

Phone Lock

Phone lock helps you protect your phone from unauthorized use.

Topics

- [Setting the Phone Lock](#)
- [Locking Your Phone Manually](#)
- [Unlocking Your Phone](#)
- [Changing Your Phone Unlock PIN](#)



Setting the Phone Lock

You can manually lock the phone or wait a specified time to automatically lock the phone.

When your phone is locked, you can:

- Dial emergency numbers.
- Reject incoming calls.
- Answer incoming calls.
- End the call.

Procedure

1. Swipe left or right to go to the second idle screen.
2. Go to **Settings > Advanced Settings** (default password: admin) > **Phone Lock**.
3. Enter the desired PIN (default PIN: 123) in the **Unlock PIN** field.
4. Select .
5. Select **Enabled** from the **Lock Enable** field.
6. Enter the desired interval (0 - 3600 seconds) in the **Auto Lock** field.
7. Select .

Note: Ask your system administrator for the password if you cannot access Advanced/Advanced Settings menu.

Locking Your Phone Manually

You can lock the phone manually before the phone is automatically locked.

Before You Begin

Make sure that the phone lock is set.

Procedure

1. Long press # key when the phone is idle.
The lock icon appears on the phone screen.

Related Topic

- [Setting the Phone Lock](#)

Unlocking Your Phone

You can use an unlock PIN to unlock the phone.

If you forget the unlock PIN, you can enter the administrator password to unlock your phone, and then automatically access the PIN change screen.

Procedure

1. Tap the screen or tap the locked key, the phone prompts you to enter an unlock PIN.
2. Enter the desired PIN (default: 123) in the **Unlock PIN** field.
3. Select **OK**.

The lock icon disappears from the phone screen.

Changing Your Phone Unlock PIN

The default unlock PIN is “123”. For security reasons, you should change the default unlock PIN as soon as possible.

Procedure

1. Swipe left or right to go to the second idle screen.
2. Go to **Settings > Basic Settings > Change PIN**.
3. Enter your old and new unlock PIN respectively.
The unlock PIN length must be within 15 digits.
4. Select .

Line Keys

Line keys allow you to quickly access features such as recall and speed dial. The line key can indicate the monitored status when the line keys are assigned with particular features, such as BLF.

You can assign predefined functions to line keys. You can also define a label for a line key feature which will appear on the phone screen.

Topics

- [Assigning Functionality to a Line Key](#)
- [Changing the Locations of the Line Keys](#)
- [Deleting a Line Key](#)

Assigning Functionality to a Line Key

You can assign functions to a line key, as a result, you can access this function quickly by tapping this line key.

Procedure

1. Do one of the following:
 - When there is no line key configured, tap  on the home screen.

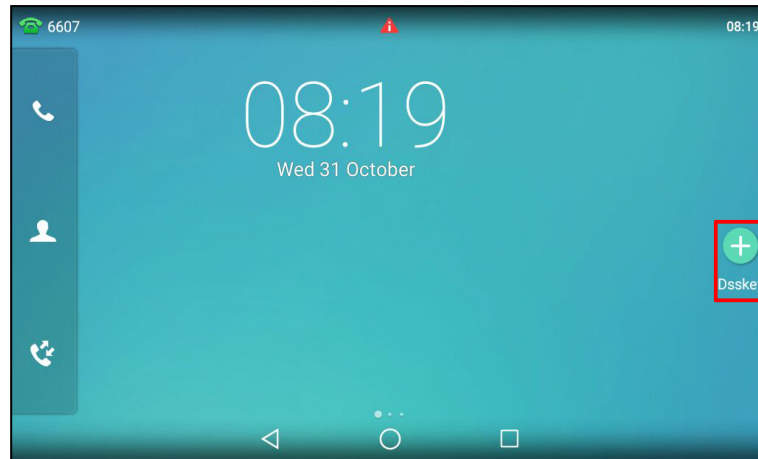

- When there is at least a line key configured, tap  on the bottom-left of the line key list.

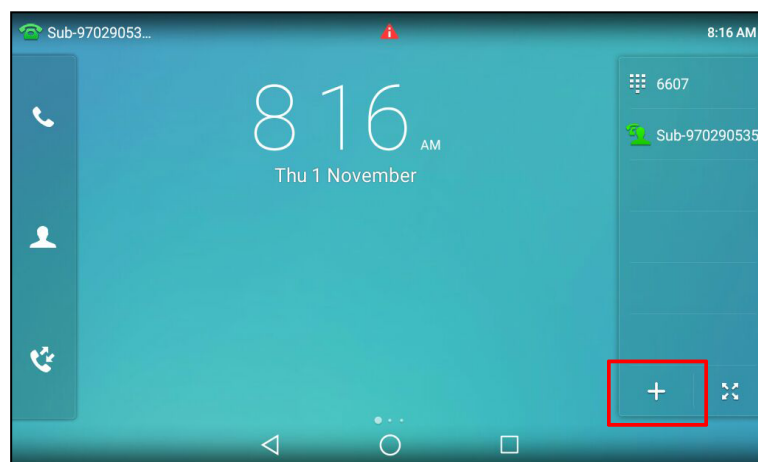

- Swipe left or right to go to the second idle screen, go to **Settings > Features > Dsskey**. Tap the desired line key.
2. Select the desired key type from the **Type** field.
 3. Configure the settings for the corresponding key type.
 4. Select .

Changing the Locations of the Line Keys

You can change the order in which your line keys display on the phone screen.

Procedure

1. Do one of the following:
 - Drag up and down to scroll through the line keys list if required.
 - Tap  on the bottom-right of the line key list.
2. Drag a line key to the desired location at which another line key locates.
 For example, exchange the locations of line key 1 and line key 2:

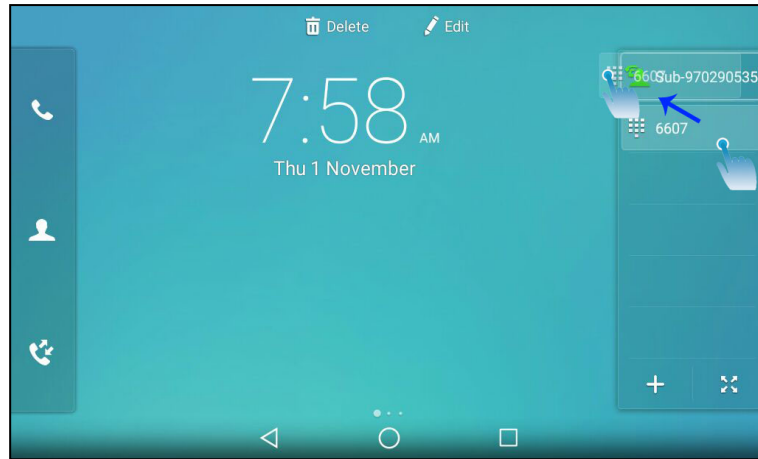

The following shows the locations of two line keys after exchange:

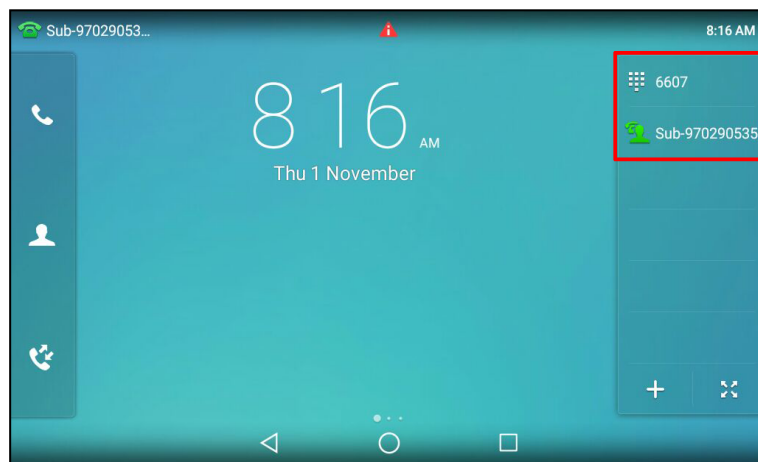

Deleting a Line Key

You can delete a line key when you no longer need the corresponding function.

Procedure

1. Drag the desired line key to the **Delete** field.

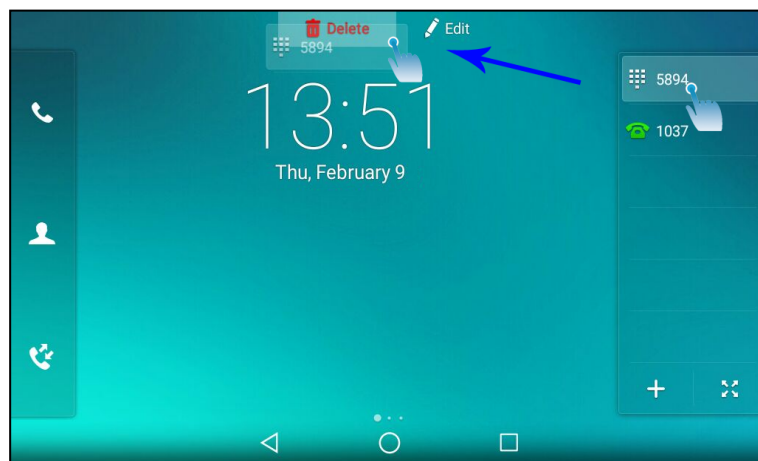

The phone prompts you to delete the DSS key or not.

2. Select **OK**.

Audio Settings

You can change the basic audio settings on your phone.

Topics

[Adjusting the Volume](#)

[Setting the Ring Tone](#)

[Disabling the Key Tone](#)

[Enabling Touch Tone](#)

[Configuring Notification Sound](#)

[Enabling Silent Mode](#)

Adjusting the Volume

You can adjust the volume of the ringer, media, and audio during a call.

Procedure

1. Press the Volume key .

Setting the Ring Tone

You can set distinctive ring tones for groups or contacts in your Local Directory so that you can identify the caller when your phone rings.

The ring tones are used according to this priority: Contact ring tone>Group ring tone>Account ring tone >Phone ring tone.

Topics

[Setting a Ring Tone for the Phone](#)

[Setting a Ring Tone for an Account](#)

[Setting a Ring Tone for a Group](#)

[Setting a Ring Tone for a Contact](#)

Setting a Ring Tone for the Phone

You can choose a ring tone for all incoming calls.

Procedure

1. Swipe left or right to go to the second idle screen.
2. Go to **Settings > Basic Settings > Sound > Ring Tones > Common**.
3. Select the desired ring tone.
4. Select .

Setting a Ring Tone for an Account

You can select a unique ring tone for an individual account.

Procedure

1. Swipe left or right to go to the second idle screen.
2. Go to **Settings > Basic Settings > Sound > Ring Tones**.
3. Select the desired account.
4. Select the desired ring tone.

*If **Common** is selected, this account will use the ring tone selected for the phone.*

5. Select .

Setting a Ring Tone for a Group

You can select a unique ring tone for various groups in your Local Directory.

Note: You can only set a ring tone for a group that is added manually.

Procedure

1. Tap  () > **Settings**.

2. Select  after the desired group.

For T58W, tap  after the desired group, and then select **Ring**.

3. Select the desired ring tone.

If **Auto** is selected, this group uses the ring tone according to the default priority.

If a specific ring tone is selected, this group uses the ring tone according to the priority: Contact ring tone>Group ring tone.

4. Select **OK**.

Setting a Ring Tone for a Contact

You can select a unique ring tone for various contacts in your Local Directory. This helps you quickly identify callers according to the ring tones.

Procedure

1. Select  ()

2. Select the contact group first.

3. Select  after the desired contact.

For T58W, tap the desired contact and then select .

4. Select the desired ring tone from the **Ring** field.

*If **Auto** is selected, the contact uses the ring tone according to the default priority.*

5. Select  or **OK**.

Disabling the Key Tone

If you disable the key tone, the phone will not produce a sound when pressing the keypad keys.

Procedure

1. Swipe left or right to go to the second idle screen.
2. Go to **Settings > Basic Settings > Sound > Key Tone**.
3. Turn off **Key Tone**.
4. Select .

Enabling Touch Tone

If you enable touch tone, the phone will produce a sound when you tap an option on the phone screen.

Procedure

1. Swipe left or right to go to the second idle screen.
2. Go to **Settings > Basic Settings > Sound > Touch Tone**.
3. Turn on **Touch Tone**.
4. Select  .

Configuring Notification Sound

The phone will produce a notification sound when receiving a notification (for example, incoming email notification).



Procedure

1. Swipe left or right to go to the second idle screen.
2. Go to **Settings > Basic Settings > Sound**.
3. Tap the desired notification sound from the **Notification Sound** field.
4. Select **OK**.
5. Select  .

Enabling Silent Mode

If you turn on the silent mode, your phone won't produce a ring tone/key tone/touch sound/notification sound from phone's speaker.

Procedure

1. Do one of the following:
 - Swipe left or right to go to the second idle screen, go to **Settings > Basic Settings > Sound**.
Turn on **Silent Mode** and then select  .
 - Press the Volume key  to adjust the ringer volume to the minimum.
 - Swipe down from the top of the screen and toggle **Silent** on.

Note: You may have no permission to turn on the silent mode. Contact your system administrator for more information.

Bluetooth

Bluetooth enables low-bandwidth wireless connections within a range of 10 meters (32 feet). The best performance is in the 1 to 2 meters (3 to 6 feet) range.

You can activate the Bluetooth mode, and then pair and connect the Bluetooth device with your phone. You can pair up to countless Bluetooth devices with your phone; however, you can connect up to two different types of Bluetooth devices at a time. You can also share files with friends via Bluetooth.

You can pair and connect a Bluetooth headset/speakerphone/microphone or a Bluetooth-enabled mobile phone to your phone. And the Bluetooth operating instructions on different Bluetooth devices are the same.

Topics

[Activating the Bluetooth Mode](#)
[Pairing and Connecting the Bluetooth Headset](#)
[Pairing and Connecting the Bluetooth-enabled Mobile Phone](#)
[Pairing and Connecting two Bluetooth Devices](#)
[Syncing the Mobile Contacts to the Phone](#)
[Handling a Mobile Phone Call on the Phone](#)
[Configuring the Phone Audio Feature](#)
[Configuring the Media Audio Feature](#)
[Changing Your Phone's Bluetooth Name](#)
[Disabling Bluetooth Device Discovery](#)
[Renaming the Paired Bluetooth Device](#)
[Sending Files via Bluetooth](#)
[Receiving Files via Bluetooth](#)
[Unpairing the Bluetooth Device](#)
[Disconnecting the Bluetooth Device](#)
[Deactivating the Bluetooth Mode](#)

Activating the Bluetooth Mode

You should activate the Bluetooth mode first when you need to connect the Bluetooth device to your phone.

Procedure

1. Do one of the following:
 - Swipe down from the top of the screen.
 - Swipe left or right to go to the second idle screen, go to **Settings > Basic Settings > Bluetooth**.
2. Turn on the Bluetooth.

The phone automatically scans the available Bluetooth devices in your area.

The Bluetooth icon appears in the status bar.

Pairing and Connecting the Bluetooth Headset

You can pair and connect the Bluetooth headset to handle calls on the phone.

Before You Begin

Make sure that the Bluetooth headset is discoverable.

Procedure

1. Swipe left or right to go to the second idle screen.
2. Go to **Settings > Basic Settings > Bluetooth**.
3. Tap  to search for the Bluetooth devices.
4. Tap the desired Bluetooth headset to connect to your phone.

The connection will be completed successfully with a prompt appears under the Bluetooth headset name.

The Bluetooth icon  appears in the status bar.

Related Topic

[Activating the Bluetooth Mode](#)

Pairing and Connecting the Bluetooth-enabled Mobile Phone

When you need to use the phone to handle the mobile phone's calls, you can pair and connect the Bluetooth-enabled mobile phone.

You can only connect one Bluetooth device at a time. After connection, the phone will automatically find an available line key and assign the line key for Mobile Account. The Mobile Account key's default label is "My Mobile". If there is no available line key, you may assign it manually.

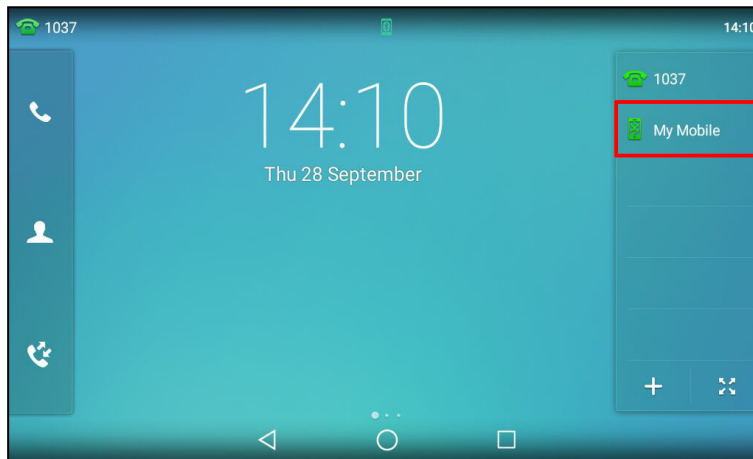

Before You Begin

Make sure that the Bluetooth-enabled mobile phone is discoverable.

Procedure

1. Swipe left or right to go to the second idle screen.
2. Go to **Settings > Basic Settings > Bluetooth**.
3. Tap  to search for the Bluetooth devices.
4. Tap the desired Bluetooth-enabled mobile phone.
5. Tap **Pair** on both mobile phone and phone.

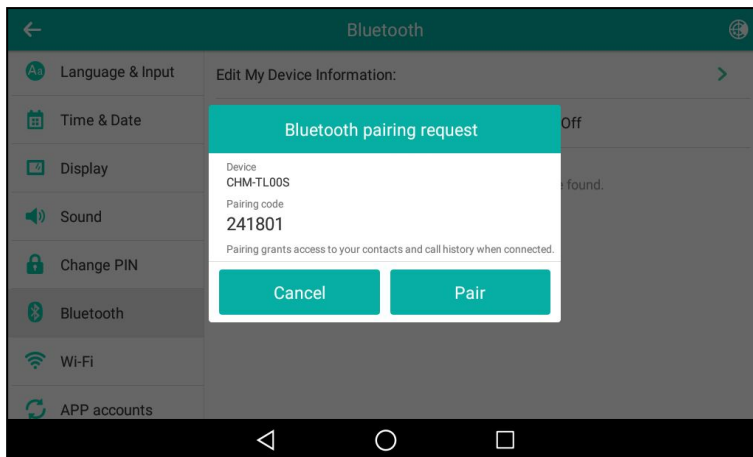

The phone prompts you to sync phone contacts temporarily.

6. Tap **OK** to enable the mobile contacts sync feature and the phone will sync the mobile contacts temporarily, or tap **Cancel** to disable mobile contacts sync feature.

The connection will be completed successfully with a prompt appears under the Bluetooth-enabled mobile phone name.

Note: If you enable mobile contacts sync feature, you also need to authorize the phone to sync the contacts temporarily on the mobile phone.

Related Topics

- [Activating the Bluetooth Mode](#)
- [Syncing the Mobile Contacts to the Phone](#)

Pairing and Connecting two Bluetooth Devices

You can connect two Bluetooth devices on the phone at a time, for example, a Bluetooth-enable mobile phone and a Bluetooth headset.

Before You Begin

Make sure that the Bluetooth devices are discoverable.

Procedure

1. Swipe left or right to go to the second idle screen.
2. Go to **Settings > Basic Settings > Bluetooth**.
3. Tap  to search for the Bluetooth devices.
4. Pair and connect the two Bluetooth devices respectively.

Note: The phone does not support connecting two Bluetooth devices of the same type at the same time. The Bluetooth channel cannot support two devices at the same time, and Bluetooth-enabled mobile phone has higher priority than the Bluetooth headset.

Syncing the Mobile Contacts to the Phone

You can sync mobile contacts to your phone. Then you can view a contact without accessing your mobile phone.

Note: Not all mobile phones support syncing the mobile contacts to phone. For more information, contact your system administrator.

Topics

- [Enabling the Mobile Contacts Sync Feature](#)

Viewing Your Mobile Contacts

Enabling the Mobile Contacts Sync Feature

You can choose to enable the phone to sync the mobile contacts.

Before You Begin

Make sure that the Bluetooth-enabled mobile phone is paired and connected to your phone and the phone audio feature is enabled.

Procedure

1. Swipe left or right to go to the second idle screen.
2. Go to **Settings** > **Basic Settings** > **Bluetooth**.
3. Tap  after the desired Bluetooth-enabled mobile phone name.
4. Select **Mobile Contacts Sync**.

You need to authorize the phone to synchronize the contacts temporarily on the mobile phone first, and then the mobile contacts directory will appear in the phone directory list.

Related Topics

[Pairing and Connecting the Bluetooth-enabled Mobile Phone](#)

[Configuring the Phone Audio Feature](#)

Viewing Your Mobile Contacts

You can view a list of mobile contacts on the phone.

Before You Begin

Make sure that the mobile contact sync feature is enabled.

Procedure

1. Go to  () > **Mobile Contacts**.

Related Topic

[Enabling the Mobile Contacts Sync Feature](#)

Handling a Mobile Phone Call on the Phone

You can handle a mobile phone call on your phone, the phone acts as a hands-free device for your mobile phone.

The call information appears on both your phone and mobile phone screen. You can control the call's audio to go through the mobile phone or phone on your mobile phone. If you choose Bluetooth, the audio will go through the phone; if you choose Handset earpiece or Speaker, the audio will go through the mobile phone.

Before You Begin

Make sure that the Bluetooth-enabled mobile phone is paired and connected to your phone, and the phone audio feature is enabled.

Procedure

1. Do the following on the phone:
 - Place a call. Tap the **Mobile Account** line key first, and then place a call or multiple calls to the mobile contacts.

- Answer a call. An incoming call to your mobile phone is also shown on the phones, you can answer the call on the phone. The phone will firstly match the contacts in the mobile contacts directory to present the caller identity.
- During the call, you can hold/resume, mute/unmute or end the call on the phone.

Related Topics



[Pairing and Connecting the Bluetooth-enabled Mobile Phone](#)
[Configuring the Phone Audio Feature](#)

Configuring the Phone Audio Feature

After syncing the mobile contacts to your phone, the phone acts as a hands-free device for your mobile phone. The call is made through your mobile phone, but the audio is present and the call control is done by the phone.

If a Bluetooth headset is connected to the phone, you can choose to answer a call using the Bluetooth headset.

Procedure

1. Swipe left or right to go to the second idle screen.
2. Go to **Settings** > **Basic Settings** > **Bluetooth**.
3. Select  after the desired Bluetooth device name.
4. Turn on **Phone audio**.
5. Select .



Related Topics

[Pairing and Connecting the Bluetooth-enabled Mobile Phone](#)
[Handling a Mobile Phone Call on the Phone](#)

Configuring the Media Audio Feature

If a Bluetooth headset is connected to the phone, you can enable the media audio feature to stream the audio from IP phone to Bluetooth headset. The Bluetooth headset acts as the player for the SIP phone.

Procedure

1. Swipe left or right to go to the second idle screen.
2. Go to **Settings** > **Basic Settings** > **Bluetooth**.
3. Select  after the connected Bluetooth headset name.
4. Turn on **Media audio**.
5. Select .

Changing Your Phone's Bluetooth Name

You can change the Bluetooth name for your phone to identify your phone to other Bluetooth devices.

By default, the phone is identified as "Yealink-T58" or "VP59" or "Yealink-SIP-T58W" by other Bluetooth devices.

Before You Begin

Make sure that the Bluetooth mode is activated.

Procedure

1. Swipe left or right to go to the second idle screen.
2. Go to **Settings** > **Basic Settings** > **Bluetooth** > **Edit My Device Information**.

3. Enter the desired name in the **Device Name** field.
4. Select .

Related Topics

[Activating the Bluetooth Mode](#)
[Disabling Bluetooth Device Discovery](#)

Disabling Bluetooth Device Discovery

After the Bluetooth is activated, the phone is automatically placed in Open Discover mode to make it visible to other Bluetooth devices.

You can choose to disable this feature to not allow your phone to show as an available device on other Bluetooth devices.

Procedure

1. Swipe left or right to go to the second idle screen.
2. Go to **Settings > Basic Settings > Bluetooth > Edit My Device Information**.
3. Turn on **Open Discover**.
4. Select .



Related Topic

[Activating the Bluetooth Mode](#)

Renaming the Paired Bluetooth Device

You can rename the paired Bluetooth device to make it recognized more easily.

Procedure

1. Swipe left or right to go to the second idle screen.
2. Go to **Settings > Basic Settings > Bluetooth**.
The phone screen shows the paired and connected Bluetooth device.
3. Tap  after the connected Bluetooth device name.
4. Enter the desired device name in the **Rename** field.
5. Tap .

*The renamed Bluetooth name will be displayed in the **PAIRED DEVICES** list on your phone. The Bluetooth device name displayed in the scanning list of other devices will not be changed.*

Unpairing the Bluetooth Device

After unpairing the Bluetooth device, next time you activate the Bluetooth, the phone will not automatically reconnect to the device. You need to scan, pair and connect with the device again.

Procedure

1. Swipe left or right to go to the second idle screen.
2. Go to **Settings > Basic Settings > Bluetooth**.
The phone screen shows the paired and connected Bluetooth device.
3. Tap  after the connected Bluetooth device name.
4. Tap **Unpair**.

Sending Files via Bluetooth

You can use the **Gallery** or **File Manager** to share pictures, videos or audio with an available Bluetooth device in your area.

Related Topics

[Sharing Pictures/Videos via Bluetooth](#)

[Sharing Pictures/Videos/Audio via Bluetooth](#)

Receiving Files via Bluetooth

The available Bluetooth devices in your area can share pictures, audio, videos, documents with your phone. You can use the corresponding system application to view the files.

Procedure

1. Share a file with the phone on your Bluetooth device.

The phone will play a notification sound, and the phone prompts you whether to accept the incoming file.

2. Tap **Accept** to start receiving the file.

The phone prompts "The file will be received. Check progress in the Notification panel.". The icon  will be displayed in the status bar.

3. (Optional.) Swipe down from the top of the screen.

Tap the notification "Bluetooth share: Received files".

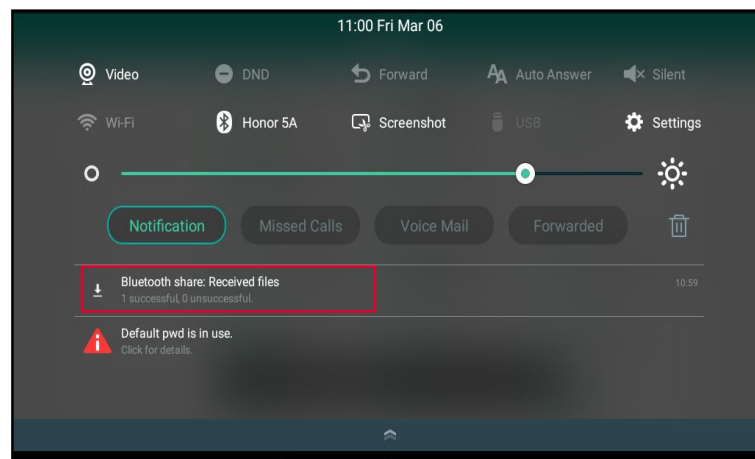

You can use the corresponding system applications to view the file.

Disconnecting the Bluetooth Device

When you disconnect a Bluetooth device, it remains paired so that you can reconnect it to your phone.

Procedure

1. Swipe left or right to go to the second idle screen.
2. Go to **Settings > Basic Settings > Bluetooth**.
3. Tap the connected Bluetooth device.
4. Tap **OK**.

Deactivating the Bluetooth Mode

You can deactivate the Bluetooth mode when you no longer use a Bluetooth device.

Procedure

1. Do one of the following:
 - Swipe down from the top of the screen.
 - Swipe left or right to go to the second idle screen, go to **Settings > Basic Settings > Bluetooth**.
2. Turn off the Bluetooth.

The Bluetooth icon disappears from the status bar.

Wireless Network

The phone can be connected to the wireless network if Wi-Fi is available within the area.

Note: Enabling Bluetooth may degrade your wireless network connection. For improved wireless network performance, you should disable Bluetooth when it is not in use.

Topics

[Activating the Wi-Fi Mode](#)
[Connecting to the Wireless Network](#)
[Viewing the Wireless Network Information](#)
[Disconnect from a Wireless Network](#)
[Deactivating the Wi-Fi Mode](#)

Related Topic

[Deactivating the Bluetooth Mode](#)

Activating the Wi-Fi Mode

You can activate the Wi-Fi mode to connect your phone to an available wireless network.

Procedure

1. Do one of the following:
 - Swipe down from the top of the screen.
 - Swipe left or right to go to the second idle screen, go to **Settings > Basic Settings > Wi-Fi**.
2. Turn on the Wi-Fi.
3. If you already turned on wireless AP, select **OK** to turn it off.

The phone automatically scans the available wireless networks in your area.

The Wi-Fi icon appears in the status bar.

Connecting to the Wireless Network

After you have activated the Wi-Fi mode, you can connect the phone to the wireless network.

When the phone is connected to a wireless network, the Wi-Fi icon  will display in the status bar.

Topics

[Connecting to an Available Wireless Network Manually](#)
[Connecting to the Wireless Network Using Wi-Fi Protected Setup](#)
[Adding a Wireless Network Manually](#)

Connecting to an Available Wireless Network Manually

You can use the password provided by your system administrator to connect the phone to a secured wireless network.



Before You Begin

Make sure that the Wi-Fi mode is activated.

Procedure

1. Swipe left or right to go to the second idle screen.
2. Go to **Settings > Basic Settings > Wi-Fi**.

The phone will automatically search for available wireless networks in your area.

3. (Optional.) To research the available network, select  > **Scan**.
4. Tap the desired wireless network (SSID) to connect to it.
5. Enter the desired password in the **Password** field.
6. (Optional.) Tap  to make the password visible.
7. Select **Show advanced options** to configure the HTTP proxy for the **Browser**.
8. Select **Connect**.

Once the connection has completed successfully, the prompt "Connected" appears under the corresponding SSID.

Related Topic

[Activating the Wi-Fi Mode](#)

Connecting to the Wireless Network Using Wi-Fi Protected Setup

You can connect to the wireless network by using the Wi-Fi protected setup (WPS) to make the connection easier.

The WPS provides simplified mechanisms to configure secure wireless networks. WPS can automatically configure a wireless network with a network name (SSID) and strong WPA data encryption and authentication.

There are two supported methods in the Wi-Fi protected setup:



- **Push Button Configuration (PBC)**: The user simply has to press the WPS key on both the phone and gateway/router to connect.
- **Personal Identification Number (PIN)**: The user enters the PIN generated randomly by the phone on the gateway/router to connect.

It is not available to T58W phones.

Before You Begin

Make sure that the Wi-Fi mode is activated.

Procedure

1. Swipe left or right to go to the second idle screen.
2. Go to **Settings > Basic Settings > Wi-Fi**.
3. Do one of the following:
 - Select  > **WPS** to use the PBC method, then long press the WPS key on your gateway or router.
Once WPS setup has completed successfully, the phone screen will prompt "Connected".
 - Select  > **WPS-PIN** to use the PIN method, then log into your gateway or router's web interface, and configure it to search the clients. For more information, refer to the documentation from the gateway or router manufacturer.

Once WPS-PIN setup has completed successfully, the web interface of the gateway or router will prompt the connection is successful.

Related Topic

[Activating the Wi-Fi Mode](#)



Adding a Wireless Network Manually

If your gateway/router has SSID broadcast disabled, it doesn't appear in the scanning results. Then you must manually add a wireless network.

Before You Begin

Get the available wireless network information from your system administrator. Make sure that the Wi-Fi mode is activated.

Procedure

1. Swipe left or right to go to the second idle screen, go to **Settings > Basic Settings > Wi-Fi**.
2. Select  > **Add**.
3. Enter the desired value in the **Network SSID** field.
4. Tap the desired value from the **Security** field.
 - If you select **WEP** or **WPA/WPA2 PSK**, enter the password.
 - If you select **802.1x EAP**, tap the desired value from the **EAP method** field, and enter additional information.
5. (Optional.) Tap  to make the password visible.
6. Select **Show advanced options** to configure the HTTP proxy for the **Browser**.
7. Select **Save**.

Related Topic

[Activating the Wi-Fi Mode](#)

Viewing the Wireless Network Information

You can view the detailed wireless network information, such as Profile Name, SSID and Signal Strength.

Procedure

1. Swipe left or right to go to the second idle screen.
2. Go to **Settings > Basic Settings > Wi-Fi > Wi-Fi Status**.
3. (Optional.) Drag up and down to scroll through the list of wireless network information.

Disconnect from a Wireless Network

You can disconnect the wireless network connection from your phone.

Procedure

1. Swipe left or right to go to the second idle screen.
2. Go to **Settings > Basic Settings > Wi-Fi**.
3. Tap the connected SSID (the top one).
4. Select **Forget**.

Tip: You can also disconnect from the wireless network by deactivating the Wi-Fi mode.

Related Topic

[Deactivating the Wi-Fi Mode](#)

Deactivating the Wi-Fi Mode

You should deactivate the Wi-Fi mode when you need to connect your phone to the wired network.

Procedure

1. Do one of the following:
 - Swipe down from the top of the screen.
 - Swipe left or right to go to the second idle screen, go to **Settings > Basic Settings > Wi-Fi**.
2. Turn off the Wi-Fi.

The Wi-Fi icon disappears from the status bar.

Wireless Access Point

The IP phone supports creating AP hotspots and sharing its wired network with other devices.

Topics

[Enabling the Wireless Access Point](#)

[Configuring Wireless Access Point](#)

[Viewing the Connected Devices](#)

[Adding Connected Devices to the Blocklist](#)

[Removing Devices from the Blocklist](#)

[Disabling the Wireless Access Point](#)

Enabling the Wireless Access Point

Procedure

1. Swipe left or right to go to the second idle screen.
2. Go to **Settings** > **Basic Settings** > **Wi-Fi AP**.
3. Turn on the Wi-Fi AP.
4. If you already turn on Wi-Fi, select **OK** to turn it off.

Configuring Wireless Access Point

You can configure the wireless access point for the device.

Before you begin

Make sure you enable wireless access point.

Procedure

1. Swipe left or right to go to the second idle screen.
2. Go to **Settings** > **Basic Settings** > **Wi-Fi AP** > **AP Configure**.
3. Enter the name of wireless AP in the **AP Name** field.
4. Select the desired security mode of the wireless AP from the **AP Security Mode** field.
If you select **WPA2-PSK**, enter the password of the wireless AP in the **AP Password** field.
5. Select the desired frequency of the wireless AP in the **AP Frequency** field.
6. Select the desired channel of the wireless AP in the **AP Channel** field.
7. Select .

Related Topic

[Enabling the Wireless Access Point](#)

Viewing the Connected Devices

Procedure

1. Swipe left or right to go to the second idle screen.
2. Go to **Settings** > **Basic Settings** > **Wi-Fi AP** > **AP Client List**.
3. View the name and MAC address of the connected device.

Adding Connected Devices to the Blocklist

You can add connected devices to the blocklist, and the device is disconnected from the wireless AP.

Procedure

1. Swipe left or right to go to the second idle screen.
2. Go to **Settings > Basic Settings > Wi-Fi AP > AP Client List**.
3. Select  after the desired device.
The phone prompts whether to move the device into the blacklist.
4. Tap **OK**.

Removing Devices from the Blocklist

You can remove devices from the blacklist, so that the devices can connect to the wireless AP provided by the phone.

Procedure

1. Swipe left or right to go to the second idle screen.
2. Go to **Settings > Basic Settings > Wi-Fi AP > AP Blocklist**.
3. Select  after the desired device.
The phone prompts whether to remove the device from blacklist.
4. Tap **OK**.

Disabling the Wireless Access Point

Procedure

1. Swipe left or right to go to the second idle screen.
2. Go to **Settings > Basic Settings > Wi-Fi AP**.
3. Turn off the Wi-Fi AP.

Optional Accessories with Your Phone

The phone can use optional accessories when you need to extend your phone's capabilities.

The following optional accessories need to be purchased separately if required for your phone:

- Analog Headset YHS33/YHS34/YHS36
- USB Headset
- Expansion Module EXP50 (only for T58A/T58W)
- Bluetooth handset BTH58 (only for T58W)

Check with your system administrator to find out which of these applications or accessories are available on your phone.

Caution: We recommend that you use the accessories provided or approved by Yealink. The use of unapproved third-party accessories may result in poor performance.

Topics

[Headset](#)

[Expansion Module and Your Phone](#)

[Connecting the Bluetooth Handset \(BTH58\)](#)

Headset

The phone supports wired headset to place and answer calls.

You can use only one headset at a time. The headset is used according to the priority: USB headset/Bluetooth headset>YHS33/YHS34/YHS36.

Topics

[Connecting the Analog Headset](#)

[Bluetooth Headset](#)

[USB Headset](#)

[Using Headsets](#)

Connecting the Analog Headset

If you want to use an analog headset, you require an optional headset YHS33/YHS34/YHS36.

Procedure

1. Simply insert the headset connector into the headset port on the back of your IP phone.

Bluetooth Headset

You can use a Bluetooth headset to handle calls on the phones.

For more information, refer to the documentation from your Bluetooth headset manufacturer.

Related Topics

[Pairing and Connecting the Bluetooth Headset](#)

[Disconnecting the Bluetooth Device](#)

[Connecting the Analog Headset](#)

USB Headset

You can use a USB headset to handle calls on the phones.

For the information on how to connect a USB headset, see the Quick Start Guide for your phone on [Yealink Support](#).

For a list of supported USB headsets, refer to [Tested headset list compatible with Yealink IP Phone](#) for your IP phones on [Yealink Support](#). USB headsets that are not listed may not function properly if you connect them to your phone.

For more information on how to use your USB headset, refer to the related documentation from the manufacturer.

Using Headsets

After connecting a headset to your phone, you can activate the headset mode and use the headset when answering and placing calls. If you do not want to use a headset to handle calls, you can deactivate the headset mode.

Procedure

1. Press the HEADSET key   on the phone.

The headset icon appears on the phone screen.

2. Press the HEADSET key   again on the phone.

The headset icon disappears from the phone screen.

Related Topics

[Switching Among the Handset, Speakerphone and Headset Modes](#)

Managing Yealink USB Headsets

After connecting a Yealink USB headset to your phone, you can configure headset settings on the phone.

Topics

[Enabling Local Ringtone](#)

Enabling Local Ringtone

You can enable the headset to play a built-in tone while receiving an incoming call.

Procedure

1. Go to **Headset > Device Setting**.
2. Enable **Local Ringtone**.
3. Select .

Expansion Module and Your Phone

The expansion module EXP50 is a console you can use to connect to a phone to add additional Ext keys and expand the functions of your phone.

For more information on expansion module EXP50, refer to the LCD Expansion Module EXP50 user guide on [Yealink Technical Support](#) page.

Only T58A/T58W phones support expansion module.

Topics

[Connecting the Expansion Module](#)

[Assigning the Features for Ext Keys](#)

[Adjusting the Screen Saver of Expansion Module](#)

[Adjusting the Backlight of Expansion Module](#)

[Changing the EXP Wallpaper from Phone](#)

[Adding an EXP Wallpaper from a USB Flash Drive](#)

Connecting the Expansion Module

You can connect the expansion module to your phone, using the supplied materials in the expansion module's packaging.

Procedure

1. Connect the expansion module to the phone using the connecting sheet and screws.
2. Connect the supplied cable from the USB jack on the host phone to the mini USB jack on the expansion module.

For more detailed information about how to connect the expansion module, refer to the LCD Expansion Module quick start guide on the [Yealink Technical Support](#) page.

Assigning the Features for Ext Keys

If EXP50 is connected to the phone, you can customize features for Ext keys.

Procedure

1. Long press the desired key on the EXP50.
The phone screen will enter the user setting interface of this key.
2. Select the desired key type from the **Type** field.
3. Configure the settings for the corresponding key type.
4. Tap .

Adjusting the Screen Saver of Expansion Module

If you connect a color-screen expansion module EXP50 to the phone, the screen saver starts or stops on both the phone and EXP50 synchronously.

Related Topic

[Screen Saver](#)

Adjusting the Backlight of Expansion Module

If you connect a color-screen expansion module EXP50 to your phone, the screen's intensity of both the phone and EXP50 will change synchronously.

Related Topic

[Changing the Screen Backlight and Time](#)

Changing the EXP Wallpaper from Phone

You can set the EXP wallpaper to make it more personalized.

Procedure

1. Swipe left or right to go to the second idle screen.
2. Go to **Settings > Basic Settings > Display > EXP Background > Wallpapers**.
3. Select the desired wallpaper image.
4. Tap **Set as exp background**.

Note: If the size of the custom picture doesn't meet the expansion module screen size, the wallpaper will be stretched or/and zoomed out according to the screen size.

Adding an EXP Wallpaper from a USB Flash Drive

You can use a picture that is stored in your USB flash drive as the EXP wallpaper on your phone.

We recommend that you add a picture less than 4.2 megapixels. Either the smaller or larger picture will be scaled proportionally to fit the screen.

Before You Begin

Make sure that the picture is in the root directory of your USB flash drive, and the USB flash drive is connected to your EXP50 successfully.

Procedure

1. Swipe left or right to go to the second idle screen.
2. Go to **Settings > Basic Settings > Display > EXP Background > Wallpapers**.
3. Select the desired wallpaper.
4. Select **Set as exp background**.

Connecting the Bluetooth Handset (BTH58)

You can use the BTH58 (Bluetooth wireless handset) on T58W phones instead wired handset.

Note: To avoid the risk of interference, we recommend that you do not use the Bluetooth handset and 2.4G Wi-Fi at the same time.

Place the handset on the phone handset cradle, three scenarios as below:

- If the handset has connected, the phone has no prompt.
- If the phone enables Bluetooth and not connected to the BTH58, the on-screen prompts "Do you want to connect BTH58 to your phone?". Tap **OK** to connect, tap **Cancel** to charge.

Note: If the phone disables Bluetooth, the on-screen prompts "Do you want to enable the Bluetooth and connect BTH58 to your phone?". Tap **OK** to enable Bluetooth and connect BTH58.

- If the phone is the first time to pair, the on-screen prompts "Do you want to enable the Bluetooth and connect BTH58 to your phone?". Tap **OK** to connect, tap **Cancel** to charge.

Note: If the phone disables Bluetooth, the on-screen prompts "Do you want to enable the Bluetooth and connect BTH58 to your phone?". Tap **OK** to enable Bluetooth and connect BTH58.

Related Topics

[LED Indicator of the BTH58](#)

Using Your Phone with PSTN Account

You can connect an optional expansion PSTN box CPN10 to extend functions of the conference phone. You can make PSTN calls.

Up to 2 cascaded PSTN Boxes can be installed to a conference phone.

Topics

[Connecting the Expansion PSTN Box CPN10](#)
[Configuring the PSTN Account](#)
[Selecting the Country for PSTN Use](#)
[Configuring the Flash Time](#)
[Basic Call Features](#)
[Conference](#)
[Recording Using a USB Flash Drive](#)
[Unavailable Features for PSTN](#)

Connecting the Expansion PSTN Box CPN10

If you want to use the functions about PSTN on the phone, you need to connect the expansion PSTN box CPN10 in advance.

Procedure

1. Insert the USB plug on the expansion PSTN box into the USB port on the phone.
For the information on how to connect expansion PSTN box CPN10, refer to PSTN Box CPN10 quick start guide on [Yealink Technical Support](#) page.

Configuring the PSTN Account

If you have connected an expansion PSTN box CPN10 to the phone, a PSTN account is automatically registered on the phone. You can disable the account.

Before You Begin

The PSTN box CPN10 is connected to the phone successfully, and the phone prompts to confirm that you want to set the PSTN account.

Procedure

1. Select **OK**.
2. Select the desired PSTN account.
3. Select the desired value from the **Activation** field.
4. (Optional.) Enter the string that will appear on the phone screen in the **Label** field.
5. Select .

Tip: You can also configure the PSTN account at the path **Settings > Advanced Settings** (default password: admin) > **Accounts**.

Related Topic

[Connecting the Expansion PSTN Box CPN10](#)

Selecting the Country for PSTN Use

You have to select the country before using the PSTN account.

Procedure

1. Swipe left or right to go to the second idle screen.
2. Go to **Settings** > **Basic Settings** > **Country**.
3. Select the desired country.
4. Select  .

Configuring the Flash Time

You can configure the flash time to adjust the length of time before a hook flash times out (or the call disconnects).

Flash time can be configured from the following options:

- **Auto**: It depends on the country that is selected for the phone. The flash time is automatically set for that country.
- **75msec, 100msec, 300msec or 600msec**: The hook flash times out after the designated time (in milliseconds).

Before You Begin

The required flash time may be different in different countries or for different gateways/PBX servers. Contact your system administrator to find out which flash time you need to configure.

Procedure

1. Swipe left or right to go to the second idle screen.
2. Go to **Settings** > **Advanced Settings** (default password: admin) > **Flash Time**.
3. Select the desired value.
4. Select  .

Related Topic

[Selecting the Country for PSTN Use](#)

Basic Call Features

The phone using PSTN account can also perform some basic call features, such as placing, answering and ending calls.

The phone supports the following basic call features when using the PSTN account:

- Placing Calls
- Answering Calls
- Ending Calls
- Auto Answer
- Auto Redial
- ReCall
- Call Mute
- Call Hold/Resume

Related Topics

[Placing Calls](#)
[Answering Calls](#)
[Ending Calls](#)
[Answering a Call Automatically](#)
[Redialing a Call Automatically](#)
[Placing a Call Back to the Last Incoming Number](#)
[Muting/Unmuting Audio](#)
[Holding and Resuming Calls](#)

Conference

As one PSTN account can only support one call, you need to activate a hook flash to set up a conference.

A hook flash is a quick off-hook/on-hook/off-hook cycle (just like picking up a handset, laying the handset down on the handset cradle, and then picking it up again).

Then the active call will be placed on hold, you are allowed to place a new call and connect three parties in a conference. You cannot view the last participant in the conference call.

You can also set up a conference with more than two parties when you have multiple accounts on the phone. You can view and manage each participant in the conference call.

Note: The way to set up a conference call using hook flash may be different for different gateways/PBX servers.

Procedure

1. Place a call to the first party.
2. When the first party answers the call, select **Flash** to activate a hook flash.
3. Enter the number of the second party.
4. When the second party answers the call, select **Flash** again to join two parties in the conference.
To remove this party from the conference call, select **Flash**.
5. To add an additional party to the conference, select **Conference** (another account is needed).
6. Enter the number of the new party and select **Send**.
7. Select **Conference** when the party answers.

Recording Using a USB Flash Drive

You can use the recording feature when you have connected the PSTN box CPN10.

Related Topics

[Call Recording](#)

[Connecting the Expansion PSTN Box CPN10](#)

Unavailable Features for PSTN

You cannot use the features below when using a PSTN account:

- Call Completion
- DND
- Call Forward
- Call Transfer
- Call Waiting
- Call Park
- Call Pickup
- Anonymous Call
- Anonymous Call Rejection
- Intercom
- Multicast Paging
- Shared Line
- Messages

Using DECT Handsets with Your Phone

You can turn Yealink IP phone into the corded-cordless phone.

The corded-cordless phone consists of a VP59/T58A/T58W phone, a DECT USB dongle DD10K and at least a handset. The supported handsets include W52H, W56H, W53H, CP930W, W59R, and DD phone. The VP59/T58A/T58W phone acts as a base station and Handset 1. You can register up to other four handsets to one phone. It allows you to manage calls when you are away from your desk.

Note that you can still use the phone features as usual on the corded-cordless phone.

Topics

[Attaching the DECT USB Dongle DD10K](#)
[Handset Registration](#)
[DECT Intercom](#)
[Repeater Mode](#)
[Satellite Mode](#)
[Shared Directory](#)
[Renaming the Handset](#)
[Locating a Handset](#)
[Changing Base PIN](#)

Attaching the DECT USB Dongle DD10K

You need to attach the DECT USB Dongle DD10K to the phone into a corded-cordless phone.

Procedure

1. Attach the DD10K into the USB port on the phone.

Handset Registration

After attaching the DD10K, you can register up to four handsets to your phone.

Topics

[Setting the Phone to the Handset Registration Mode](#)
[Registering a Handset to the Phone](#)
[De-registering a Handset on the Handset](#)
[De-registering a Handset on the Phone](#)

Setting the Phone to the Handset Registration Mode

You have to set the phone to the handset registration mode before you register a handset to the phone.

Before You Begin

Make sure you have attached a DD10K to the phone.

Procedure

1. Swipe left or right to go to the second/third idle screen.
2. Go to **DECT Settings > Handsets**.
3. Select **Register**.

The phone prompts you to register your handset.

Related Topic

[Attaching the DECT USB Dongle DD10K](#)

Registering a Handset to the Phone

The corded-cordless phone acts as a base station and Handset 1. You can register other handsets to the phone.

Before You Begin

Make sure the phone is in the handset registration mode.

Procedure

1. Do one of the following on the handset:
 - Go to **OK** > **Register Handset**.
 - Go to **OK** > **Settings** > **Registration** > **Register Handset**.

The handset begins searching for the phone.

2. Press **OK** after a phone is found.
3. Enter the base PIN (default: 0000), and then press **OK**.

The handset prompts you that the handset is registered successfully.

Tip: When registering a new handset, press the **Reg** soft key to register the handset quickly.

Related Topic

[Setting the Phone to the Handset Registration Mode](#)

De-registering a Handset on the Handset

You can de-register a handset on the handset when you no longer want to use the current base station.

Procedure

1. Go to **OK** > **Settings** > **Registration** > **De-reg. Handset**.
2. Enter the base PIN (default: 0000), and then press **Done**.

The phone displays the handsets that are registered to the same phone. The name of your handset is highlighted.

3. Highlight the desired handset and then press **OK**.
4. Press **Yes**.

The phone prompts you to de-register the handset or not.

Related Topic

[De-registering a Handset on the Phone](#)

De-registering a Handset on the Phone

You can de-register a handset on the phone when you no longer need this handset.

Procedure

1. Swipe left or right to go to the second/third idle screen.
2. Go to **DECT Settings** > **Handsets**.
3. Select **Delete**.
4. Enter the base PIN (default: 0000), and then select **OK**.

Related Topic

[De-registering a Handset on the Handset](#)

DECT Intercom

When the handset is registered to the phone successfully, you can place/receive a DECT intercom call to/from the handset registered to your phone.

Topics

[Configuring Auto Intercom](#)

[Placing a DECT Intercom Call on the Handset](#)

[Placing a DECT Intercom Call on the Phone](#)

[Placing a DECT Intercom Call with a DECT Intercom Key](#)

[Performing a Blind Transfer to the Handset](#)

[Merging the DECT Intercom Call with SIP Call into a Conference](#)

Configuring Auto Intercom

You can configure the phone to automatically answer an incoming internal intercom call and play a warning tone.

The following types of warning tones are available:

- **On (Beep On):** The phone answers an incoming internal intercom call automatically and plays a warning tone.
- **On (Beep Off):** The phone answers an incoming internal intercom call automatically without a warning tone.
- **Off:** Auto intercom feature is off. You need to answer an incoming internal intercom call manually.

Procedure

1. Swipe left or right to go to the second/third idle screen.
2. Go to **DECT Settings > Auto Intercom**.
3. Select a desired option from the **Auto Intercom** field.
4. Tap .

Note: Your system administrator can configure the auto intercom feature for your phone and the registered handsets at the same time.

Placing a DECT Intercom Call on the Handset

You can place a DECT intercom call to a handset registered to the same phone, or place a DECT intercom call to the phone that you register the handset to.

Up to two intercom calls can be set up on the handset.

Procedure

1. Go to **OK > Intercom**.
*The phone screen displays the names of all registered headsets and the **All Handsets** option.*
2. Highlight the desired handset or phone.
3. Press **OK** to dial out.

Related Topics

[Handset Registration](#)

[Placing a DECT Intercom Call on the Phone](#)

Placing a DECT Intercom Call on the Phone

You can place a DECT intercom call to a handset registered to the phone.

Procedure

1. Go to  () > **DECT Intercom**.

The phone screen displays the names of all registered headsets.

2. Tap the desired handset.

The corresponding handset will ring.

Related Topics

[Handset Registration](#)

[Placing a DECT Intercom Call on the Handset](#)

Placing a DECT Intercom Call with a DECT Intercom Key

You can quickly dial a handset registered to your phone through the DECT Intercom key.

Procedure

1. Swipe left or right to go to the second idle screen.
2. Go to **Settings** > **Features** > **Dsskey**.
3. Tap the desired line key.
4. Select **DECT Intercom** from the **Type** field.
5. Select a target handset from the **Select handset** field.
6. (Optional.) Enter the string that will appear on the phone screen in the **Label** field.
7. Tap .
8. Place a DECT intercom call by tapping a DECT Intercom key when the phone is idle.

Tip: You can drag the line key to the **Edit** field to set a DECT Intercom key.

Performing a Blind Transfer to the Handset

You can quickly transfer a SIP call to the handset registered to your phone.

Procedure

1. When the phone is during a call, do one of the following:
 - Drag the far-site window to a DECT Intercom key.
 - Tap **Transfer**.

Go to  () > **DECT Intercom**.
Tap the desired handset.

Related Topic

[Placing a DECT Intercom Call with a DECT Intercom Key](#)

Merging the DECT Intercom Call with SIP Call into a Conference

You can merge the current DECT intercom call with a SIP call into a conference.

Procedure

1. Place a DECT intercom call and a SIP call on the phone.
2. Do one of the following:
 - Drag one far-site window to the other far-site window.
Tap **Conference** from the pop-up box.
 - Tap the desired call for a conference and ensure that the call is active.
Tap **Conference**.
Tap the Hold call to join the conference.

Repeater Mode

Repeater mode extends the radio coverage of the phone. The repeater has the same radio coverage as the base station.

This feature is especially useful for users who require mobility in large dwellings. If the repeater mode is enabled, and a repeater is registered to the base station, the handset registered to the base station can be used either in the base station or the repeater coverage area, thereby providing users with greater freedom in mobility.

The VP59/T58A/T58W phone is compatible with DECT repeater RT10/RT20/RT20U/RT30.

Topics

[Enabling the Repeater Mode](#)

[Setting the Phone to the Repeater Registration Mode](#)

[Registering a Repeater](#)

Enabling the Repeater Mode

You have to enable the repeater mode before you register a repeater.

Procedure

1. Swipe left or right to go to the second/third idle screen.
2. Go to **DECT Settings > Repeater Mode**.
3. Select a repeater from the **Repeater Mode** field.
4. Tap .

The phone prompts you to reboot the dongle or not.

5. Tap **OK**.

The repeater mode is enabled after the dongle reboot.

Setting the Phone to the Repeater Registration Mode

After enabling the repeater mode, you have to set the phone to the repeater registration mode.

Procedure

1. Swipe left or right to go to the second/third idle screen.
2. Go to **DECT Settings > Handsets**.
3. Tap **Register Repeater**.

The phone is in the repeater registration mode now.

Related Topic

[Enabling the Repeater Mode](#)

Registering a Repeater

You need to register a repeater if you want to extend the radio coverage of the phone.

Before You Begin

The repeater mode is enabled, and the phone is in the repeater registration mode.

Procedure

1. Plug the repeater into an AC outlet.
POWER LED glows green and DECT LED flashes red.
2. Enable the repeater registration mode on the phone.
If a phone is found, DECT LED will flash orange.

When DECT LED glows green/orange, the registration to the phone is successful.

Related Topics

[Enabling the Repeater Mode](#)

[Setting the Phone to the Repeater Registration Mode](#)

Satellite Mode

You can bind a W53H/W56H/W59R handset with the VP59/T58A/T58W phone to use the satellite mode.

The phone account is applied to the handset, and all line statuses (for example, DND) on the phone and the handset are synchronized. You can use the phone while you are sitting at your desk, and use the handset while away from your desk to enhance your business activities.

The phone and the handset can share contacts. For more information, refer to [Shared Directory](#).

Satellite mode is available only when one handset is registered. For more information, refer to [Handset Registration](#).

Note: After the handset is bound to your phone, the assigned outgoing/incoming line(s) configured for the handset by your administrator is disabled.

Topics

[Selecting a Handset to Use the Satellite Mode](#)

[Push an Active Call to the Handset](#)

[Pull an Active Call from the Handset](#)

Selecting a Handset to Use the Satellite Mode

You can select a handset to use the satellite mode with the phone, and configure a mode for whether to continue the conversation of the handset when the phone goes off-hook.

There are two satellite modes:

- **Busy:** You cannot switch the active call between the phone and the handset. Regardless of the phone or the handset, the device in a call can initiate a new call. If you are not in a call and try to initiate a call on the phone/handset, the phone/handset screen will prompt "Path Busy".
- **Take over call:** When the handset is during the call, you can retrieve the call from the handset to the phone after off-hook. When the phone is during the call, you can push the call to the handset.

Procedure

1. Swipe left or right to go to the second/third idle screen.
2. Go to **DECT Settings > Satellite Mode**.
3. Select the desired handset.
4. Select a mode from the **Select mode** field.
5. Tap  .

Related Topics

[Pull an Active Call from the Handset](#)

[Push an Active Call to the Handset](#)

Push an Active Call to the Handset

You can push the active call from the phone to the handset.

Before You Begin

The phone is during a call, and the satellite mode is selected as **Take over call**. And make sure there is only one call on the phone.

Procedure

1. Swipe the soft key area left and then tap **Call Shift**.

The call is automatically connected on the handset.

Related Topic

[Selecting a Handset to Use the Satellite Mode](#)

Pull an Active Call from the Handset

You can retrieve the call from the handset to the phone after off-hook.

Before You Begin

The handset is during a call, and the satellite mode is selected as **Take over call**. And make sure there is only one call on the handset.

Procedure

1. Do one of the following:
 - Pick up the handset.
 - Press the Speakerphone key .
 - Select the line key, and then select **Call Pull**.

The call is connected to the phone.

Related Topic

[Selecting a Handset to Use the Satellite Mode](#)

Shared Directory

Users can manage contacts and use them on the phone and all registered handsets. You can store up to 1000 contacts in your phone's shared directory.

Check with your system administrator to find out if this feature is available on your phone.

Note: For more information on how to bind a handset, refer to [Selecting a Handset to Use the Satellite Mode](#).

Topics

[Adding Shared Contacts](#)

[Viewing Shared Contacts](#)

[Editing Shared Contacts](#)

[Deleting a Shared Contact](#)

[Deleting All Shared Contacts](#)

[Searching for Shared Directory Contacts](#)

[Moving a Shared Contact to the Blocklist Directory](#)





[Saving a Shared Contact to the Local Directory](#)

[Placing a Call from the Shared Directory](#)

Adding Shared Contacts

When you add a contact to your Shared Directory, you can set the desired information for your contact. You are required to enter a contact name at least for each new contact.

Procedure

1. Go to  () > **Share Directory**.
2. Tap  (+).
3. Enter the shared contact's information.
4. Tap .

Viewing Shared Contacts

You can view the shared contacts from the Shared Directory on your phone.





Procedure

1. Go to  () > **Share Directory**.

Editing Shared Contacts

You can modify or add more information to your contacts.





Procedure

1. Go to  () > **Share Directory**.
2. Tap  beside the contact.
For T58W, tap the desired contact and then select .
3. Edit the shared contact information.
4. Tap .

Deleting a Shared Contact

You can delete any contact from the Shared Directory.





Procedure

1. Go to  () > **Share Directory**.
2. Tap  > **Delete**.
For T58W, tap the desired contact and then select  > **Delete**.
The phone prompts whether to delete the contact.
3. Tap **OK** to delete.

Deleting All Shared Contacts

You can delete all contacts from the Shared Directory.



Procedure

1. Go to  () > **Share Directory**.
2. Tap **Settings** > **Select All**.
For T58W, tap  > **Select All**.
3. Tap .
The phone prompts whether to delete all contacts.
4. Tap **OK** to delete.

Searching for Shared Directory Contacts

In the Shared Directory, you can enter the search criteria to find your desired contact quickly.

Procedure

1. Go to  () > **Share Directory**.
2. Tap **Search** or .
3. Enter the name or number you are looking for in the search field.

The contacts will be displayed in the result list.

Moving a Shared Contact to the Blocklist Directory

You can move a shared contact to the Blocklist directory. The shared contacts added to the Blocklist directory will not disappear, even if you disable the shared directory feature.

Procedure

1. Go to  () > **Share Directory**.
2. Tap  beside the contact.

For T58W, tap the desired contact and then select .

3. Tap **Blocklist**.

For T58W, select **Move to Blocklist**.





The phone prompts you to move the contact or not.

4. Tap **OK**.

Saving a Shared Contact to the Local Directory

You can move a shared contact to the Local Directory. The shared contacts added to the Local Directory will not disappear, even after your system administrator disabled the Shared Directory feature.



Procedure

1. Go to  () > **Share Directory**.
2. Tap **Settings**.
For T58W, tap .
3. Select a contact.
4. Press **Options** and then select **Add To Local**.
For T58W, tap .
5. Tap **New Entry**.
6. Tap  or **OK**.

Placing a Call from the Shared Directory

You can place a call to a contact directly from the Shared Directory.

Procedure

1. Go to  () > **Share Directory**.
2. Tap the desired contact.
If the selected contact has multiple numbers, tap the desired number.

Related Topic

[Searching for Shared Directory Contacts](#)

Renaming the Handset

You can personalize the handset name on the phone.

Procedure

1. Swipe left or right to go to the second/third idle screen.
2. Go to **DECT Settings > Handsets**.
3. Tap  beside the handset name.
4. Enter the desired handset name.
5. Select **OK**.

Locating a Handset

You can locate a misplaced registered handset by the phone.

Procedure

1. Swipe left or right to go to the second/third idle screen.
2. Go to **DECT Settings > Handsets**.
3. Tap **Start Paging**.

All handsets that are registered to the phone will ring (paging) simultaneously and display the IP address of the phone on the screen.

You can tap **Stop Paging** on the phone to end ringing (paging).

Changing Base PIN

To avoid unauthorized registration or access to some features on the phone, you should keep the base PIN secret.

Procedure

1. Swipe left or right to go to the second/third idle screen.
2. Go to **DECT Settings > Change Base PIN**.
3. Enter the current PIN (default: 0000) in the **Change Base PIN** field.
4. Enter the new PIN in the **Enter New PIN** and the **Re-enter new PIN** fields.
5. Tap .

Note: If the double PIN feature is enabled by your system administrator, you can only use the registration PIN to register a handset. Contact your system administrator for more information.

Maintaining Your Phone

When your phone is unable to operate properly, you need to investigate or troubleshoot issues along with other tasks your system administrator may ask you to perform.

Topics

[Investigating Warnings](#)
[Clearing Warning Icon](#)
[Diagnosing the Network](#)
[Rebooting Your Phone](#)
[Resetting to Factory Settings](#)
[Updating the Phone Configuration](#)
[Clearing User's Personalized Configuration Settings](#)

Investigating Warnings

The warning icon lets you know that your phone has one or more important issues.

Procedure

1. Swipe left or right to go to the second idle screen.
2. Go to **Settings** > **Status** > **General**.

*The warning detail is displayed in the **Warning** field.*

Clearing Warning Icon

You can temporarily remove the warning icon from the status bar. However, the warning message still is displayed on the **Status** screen until the issue is fixed.

The warning icon appears in the status bar again after reboot if the issue is not fixed.

Procedure

1. Swipe left or right to go to the second idle screen.
2. Go to **Settings** > **Status** > **General**.
3. Tap the **Warning** field.

The phone prompts you to clear the warning icon or not.

4. Tap **OK**.

*The warning icon  is removed from the status bar. And it is also removed from the **Warning** field.*

Tip: You can also swipe left or right to temporarily remove the warning icon via Notification Center.

Related Topic

[Control Center and Notification Center](#)

Diagnosing the Network

When network problems occur on your phone, you can use the "ping" or "trace route" method to troubleshoot network connectivity problems.

Procedure

1. Swipe left or right to go to the second idle screen.
2. Go to **Settings** > **Features** > **Diagnostics** > **Network**.

3. Do one of the following:
 - Select **Ping**, then enter the desired IP address or URL in the **Ping IP or URL** field.
 - Select **Trace Route**, then enter the desired IP address or URL in the **Trace Route IP or URL** field.
4. Select **Start**.

The screen displays the network status information.

Rebooting Your Phone

The improper operation may cause malfunction. If the malfunction occurs, your system administrator may ask you to reboot your phone.

Procedure

1. Swipe left or right to go to the second idle screen.
2. Go to **Settings > Basic Settings > Reboot > Reboot**.
The phone prompts you to reboot the phone or not.
3. Select **OK**.

Tip: You can also long press the * key on the keypad when the phone is idle to reboot the phone.

Resetting to Factory Settings

When some issues occur on your phone and you have tried all troubleshooting suggestions but still do not solve the problem, you can reset your phone to factory configurations.

This operation will delete all your personal configuration settings, and reset all settings to the factory defaults. Check with your system administrator if the personalized settings are kept before resetting your phone to factory settings.

Procedure

1. Swipe left or right to go to the second idle screen.
2. Go to **Settings > Advanced Settings** (default password: admin) > **Reset Config**.
2. Select **Reset to Factory Settings**.
The phone prompts you to reset the setting or not.
3. Select **OK**.

The phone begins resetting.

Tip: You can also long press the Redial key  when the phone is idle.

After reset, the screen prompts "Welcome Initializing...Please wait".

The phone will be reset successfully after startup.

Note: Reset of your phone may take a few minutes. Do not power off until the phone has started up successfully.

Updating the Phone Configuration

Your system administrator may ask you to update the configuration for your phone to apply any changes to system settings, which you can do without restarting it.

Procedure

1. Swipe left or right to go to the second idle screen.
2. Go to **Settings > Basic Settings > Update Configuration**.

3. Enter the provision information in the corresponding field.
4. Select  .
The phone prompts you whether to provision now.
5. Select **OK**.

Clearing User's Personalized Configuration Settings

You can clear the personalized configuration settings manually on the phone.

Before You Begin

Your system administrator has enabled the phone to keep the user's personalized settings after auto provisioning.

Procedure

1. Swipe left or right to go to the second idle screen.
2. Go to **Settings > Basic Settings > Reset Local Config> Reset local settings**.
The phone prompts you to reset the local settings or not.
3. Select **OK**.

Appendix - Menu Structure

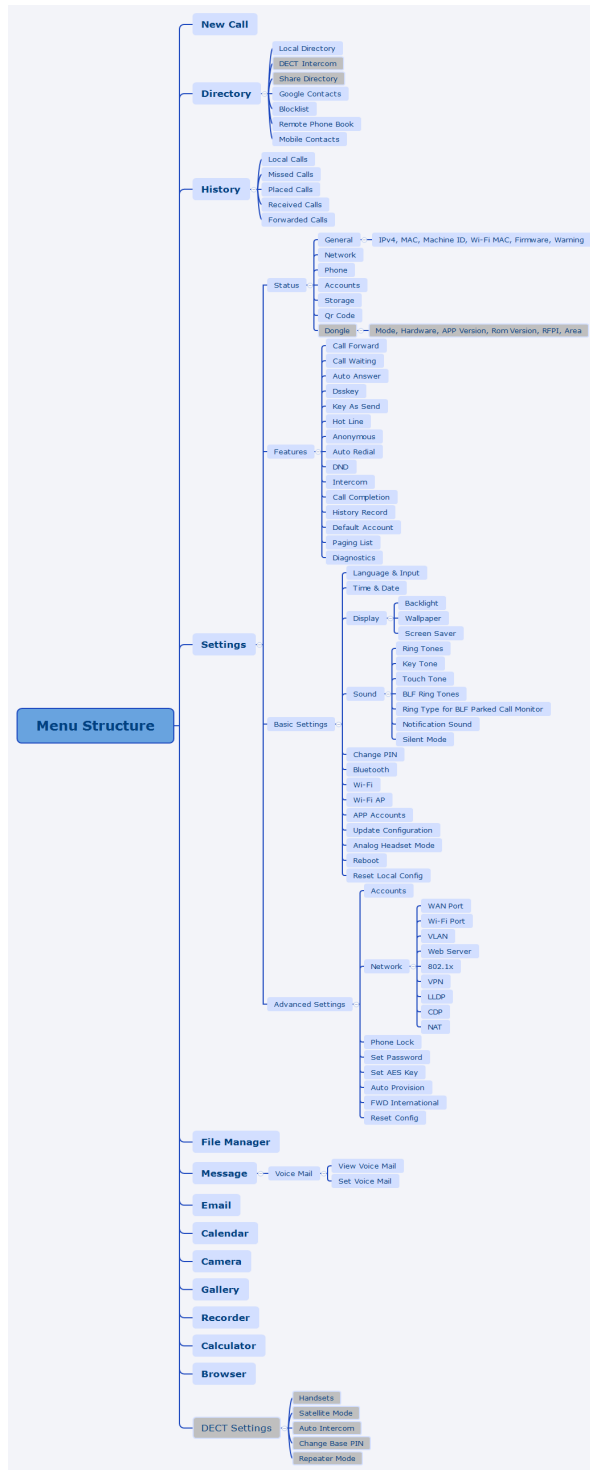

Note: The menus with gray box are not available when the DECT USB dongle DD10K is not attached to the phone.