

Yealink

MP50

User Guide



MOMENTUM

24Q1

MP50 Product Introduction

Yealink MP50 is a brand-new and affordable USB phone which can integrate a variety of devices into a single phone via a USB wired connection and Bluetooth wireless pairing, creating an all-in-one UC workstation. MP50 features a 4.0-inch capacitive touch screen and consistent Teams-tailored interaction, which will provide you with a UC calling experience with PC and Mobile.



4-inch Multi-touch Screen



HD Audio



HAC



Bluetooth



USB Hub



Busylight



Plug and Play

Key Features

- 4.0 inch (480 x 800) Capacitive Touch Screen
- 3-ports USB 3.0 Hub
- Supports Bluetooth Headset
- Supports BT50 Dongle for PC
- Supports Busylight
- Optimal HD Audio
- Yealink Noise Proof Technology
- Full-duplex Hands-free Speakerphone with AEC
- Dedicated Teams Button
- Microsoft Teams-tailored User Interface
- Teams and Skype for Business Compatible



Ideal All-in-one UC Workstation

For users who want an efficient productivity workspace, the MP50 is designed as an all-in-one UC workstation, that can be connected to all your UC devices for unified call control.

1. With mobile phone connected, MP50 can provide the mobile phone calling experience by leveraging the wireless Bluetooth Technology.
2. The integrated 3-port USB hub would extend your personal PC USB port usage, you can add multiple peripherals to your PC via a single USB port.
3. MP50 can also be used as a speakerphone that presents the immersive sound for either hands-free calling or music.

Plug and Play

As a USB phone, simply connect the MP50 to any PC or mobile, it will be automatically recognized and instantly be ready to start placing or receiving phone calls, rewarding you with a trouble-free plug-and-play experience. MP50 supports Yealink USB Connect deployment, making it simple to manage and upgrade, compared with Android Phones there will be less work for the admin to do the maintenance.

Excellent User Experience

The MP50 is compatible with Microsoft Teams, Skype for Business and more UC applications, and is intuitive and easy to use with an efficient 4.0-inch capacitive touch screen, classic handset and hard dial pad. Thanks to Yealink Optima HD voice, and the hardware of full-duplex hands-free speakerphone with AEC and HAC handset, MP50 can deliver a crystal-clear voice communications experience.

Specifications

Specifications	Introduction
Audio Features	<ul style="list-style-type: none"> · HD voice: HD handset, HD speaker · Hearing aid compatible (HAC) handset · Full-duplex hands-free speakerphone with AEC · Noise suppression (NS) · Digital Signal Processing (DSP) · Adaptive Jitter Buffer (AJB) · Automatic Gain Control(AGC)
Call Features	<ul style="list-style-type: none"> · Incoming/Outgoing P2P call · Mobile PSTN Calling · Call hold/Call mute · Mobile Calling Experience via Bluetooth
Other Features	<ul style="list-style-type: none"> · Screensaver · Built-in Bluetooth · Supports Busylight (Optional) · Supports BT50 Dongle (Optional) · Reset to factory, reboot
Display and Indicator	<ul style="list-style-type: none"> · 4.0" 480 x 800 capacitive touch screen · Two-angle [45°/ 53°] stand · Multi-language user interface · Modern Teams interface · LED for call and message waiting indication
Interface	<ul style="list-style-type: none"> · 3 x USB 3.0 Type A Ports for PC: <ul style="list-style-type: none"> - USB device - Bluetooth device via BT50 · 1 x Security lock port · 1 x 12V DC power port · 1 x 2.5mm Busylight port · 1 x RJ9 (4P4C) handset port · 1 x RJ9 (4P4C) headset port
Other Physical Features	<ul style="list-style-type: none"> · External Yealink AC adapter: AC 100~240V input and DC 12V/1A output · USB output currency: 5V 500mA · Power consumption (PSU): 1.23W-9.6W · Dimension (W * D* H * T): 223 mm x 159 mm x 127 mm x 36 mm · Operating humidity: 10~95% · Operating temperature: -10~50°C (+14~122°F)

Key Features

Package Features

- Package content:
- Yalink MP50 USB phone
- Handset with handset cord
- Power Adapter
- Stand
- Quick Start Guide
- Busylight (Optional)
- BT50 Dongle (Optional)
- Qty/CTN: 5 PCS
- N.W/CTN: 4.6 kg
- G.W/CTN: 5.1 kg
- Giftbox size: 249 mm x 179 mm x 103 mm
- Carton Meas: 529 mm x 188 mm x 261 mm

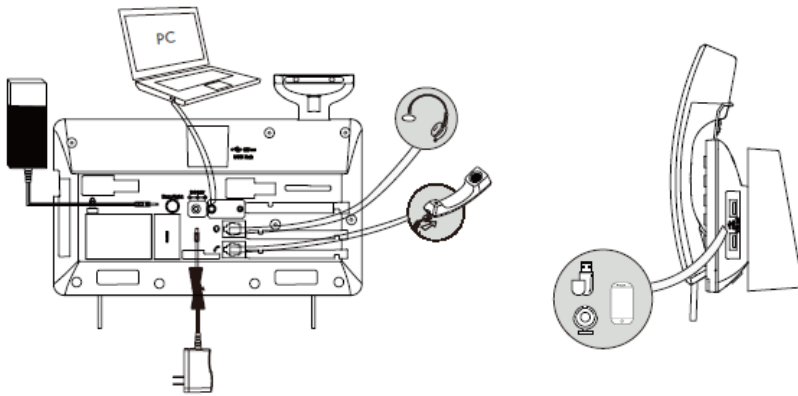
Connection

For more information, please go to the [Yalink official website](#).

Compatibility List

MP50 Compatibility List

For the PC

OS	Connectivity	Softphone	Description
Windows 8 or higher MAC 10.14.6 or higher	USB Cable	- Microsoft Teams Skype for business	- Incoming call ringtone - Answer/reject/end call - Mute call - Adjust volume - Play music

Getting Started

Package Contents

After opening the MP50 package, check that all the items on the list are included. If any items are missing, contact your dealer.

- **Standard**

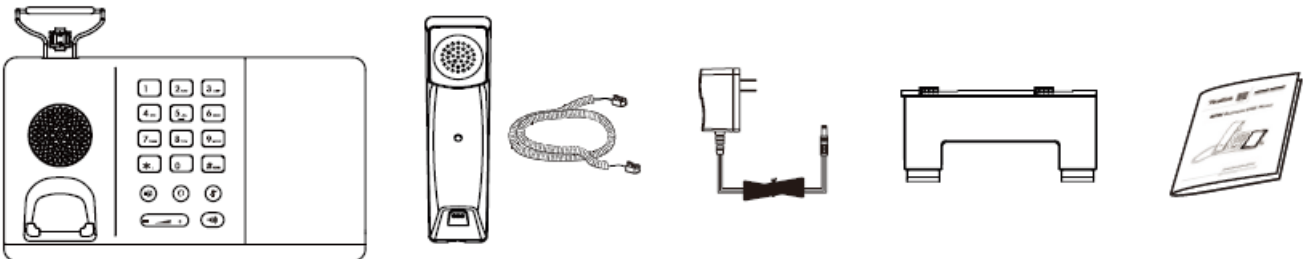

- **Optional**



Bluetooth USB dongle BT50

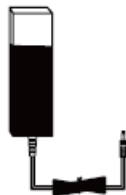

Busylight BLT60

TIP

We recommend that you use the included accessories, and other accessories may have compatibility issues that prevent them from working properly.

Overview

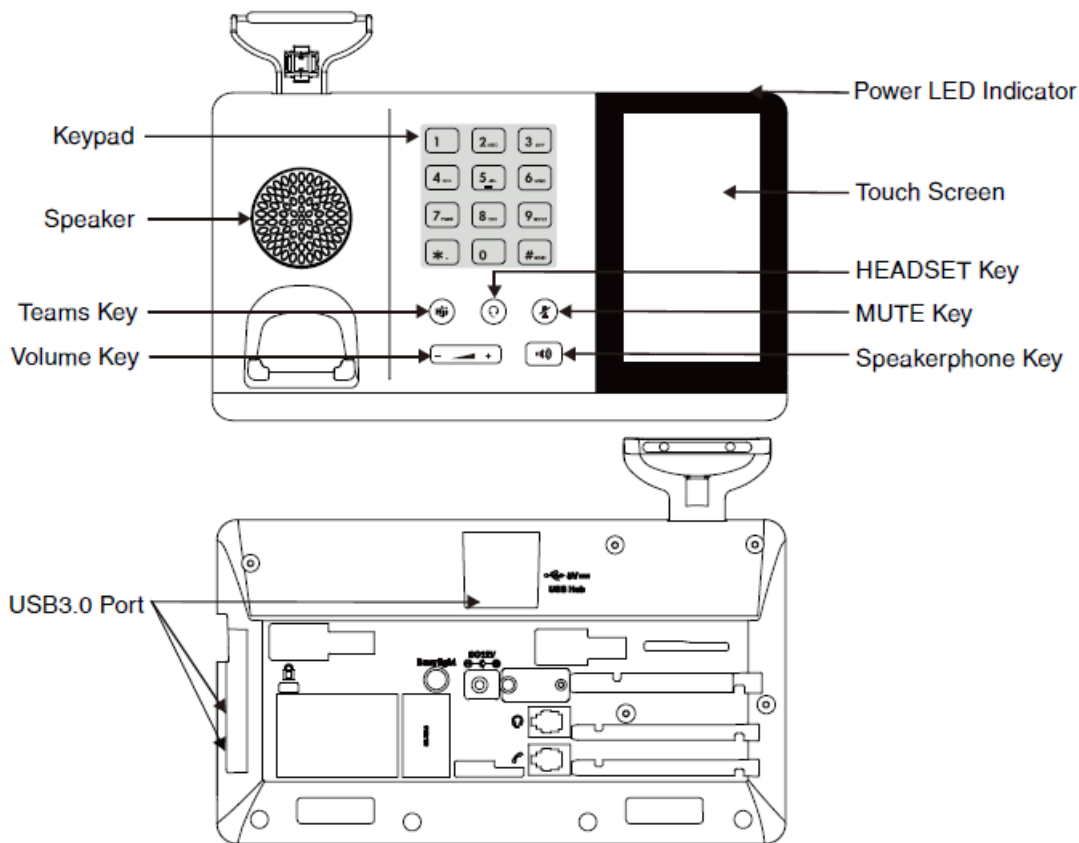

Item	Description
Power LED Indicator	Indicates phone status.
Touch Screen	Allows you to select items and navigate menus on the touch-sensitive screen.
HEADSET Key	Toggles and indicates the headset mode. The key LED glows green when headset mode is activated.
MUTE Key	Toggles and indicates mute feature. The key LED glows red when the call is muted.
Speakerphone Key	Toggles and indicates the hands-free (speakerphone) mode. The key LED glows green when the hands-free (speakerphone) mode is activated.
Keypad	Provides the digits and special characters in context-sensitive applications.
Speaker	Provides hands-free (speakerphone) audio output.
Teams Key	<ul style="list-style-type: none"> Hold for 2 seconds to activate Cortana integrated in Teams (this requires Microsoft's support). Press once to invoke the Teams client in the idle state.
Volume Key	Adjusts the volume of the handset, headset, and speaker.
USB 3.0 Port	Allows you to connect a USB headset/USB flash drive/Bluetooth dongle BT50 and so on.

NOTE

Before using the Teams button functions, you should install the Microsoft Teams client on your PC, smartphone or tablet.

Busylight BLT60

What Does Busylight Work For?

OPTIONAL With its star/heart/square shape light guide, people around you can always know your working stat no matter which one you choose. It synchronously displays the current desk phone/softphone presence state with the colors. For example, when BLT60 turns red, you are on a call, and people will not interrupt you.

In addition, the Yealink BLT60 is with 1.8m long cord, which allows you to place the light wherever it' s easily seen, for example, the corner of your desk or the PC monitor. When you are away from your desk while the Yealink BLT60 is flashing red, you can still know here comes the call and never miss it, even if there is no bell reminder.

Package Content

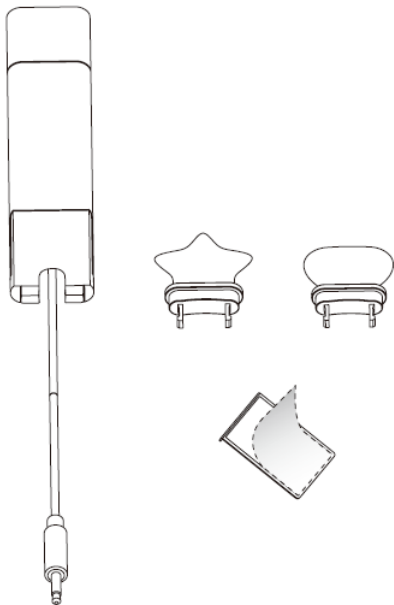

How to Use

1. install.

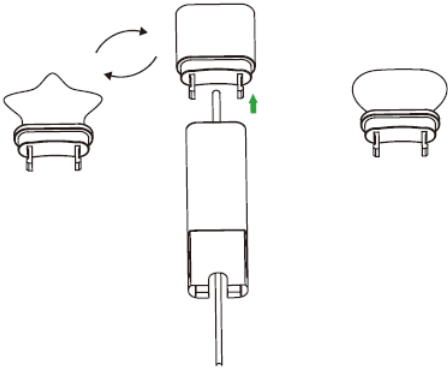

2. At the back of base station, there is an interface for you to connect busylight BLT 60. Please do not mess it up with the power supplier interface though they are very similar. When the BLT60 light turns up, that means it is connected correctly.

3. Stick to device.

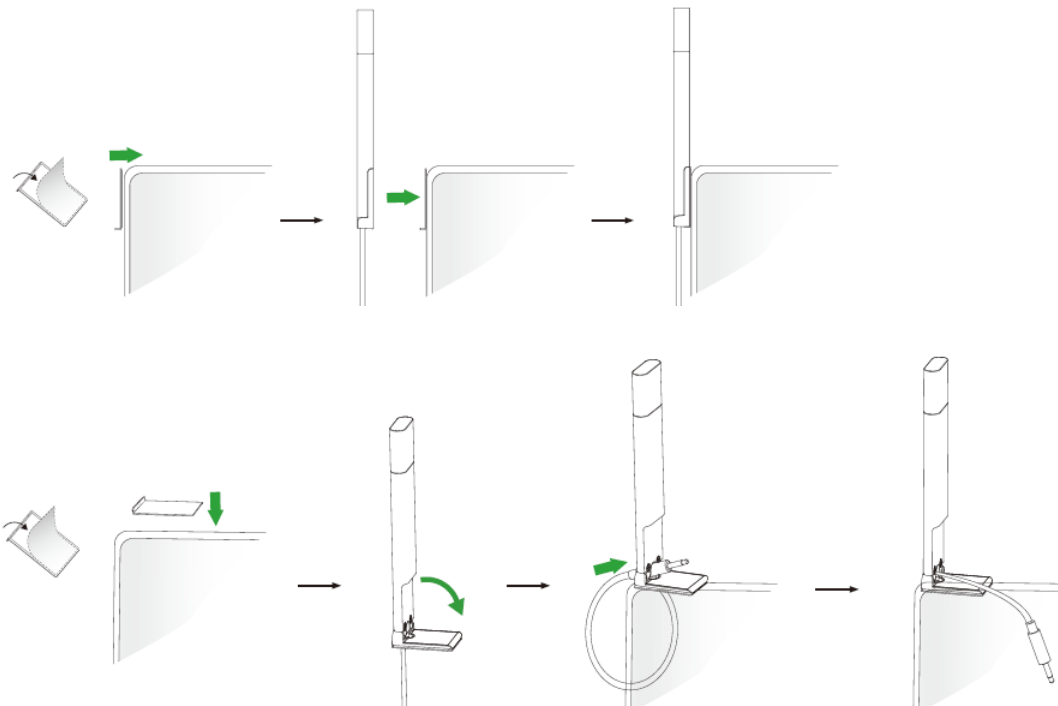

LED Indicator

The phone can use optional accessories when you need to extend your phone's capabilities.

The Busylight BLT60 needs to be purchased separately if required for your phone:

- **Online Status** (sync status requires softphone support)

LED Indicator	Description
Solid green	Available
Solid orange	Away
Solid red	DND/Busy

Off	Turn off the busylight, softphone does not support
-----	--

- **Talking Status**

LED Indicator	Description
Flash red	Ringing
Solid red	In a call
Flash green slowly	Missed call/voice message notification (this requires softphone support)
Off	Softphone does not support, turn off the busylight

Charge

MP50 Charging

Charge MP50

You can do the following to charge MP50.

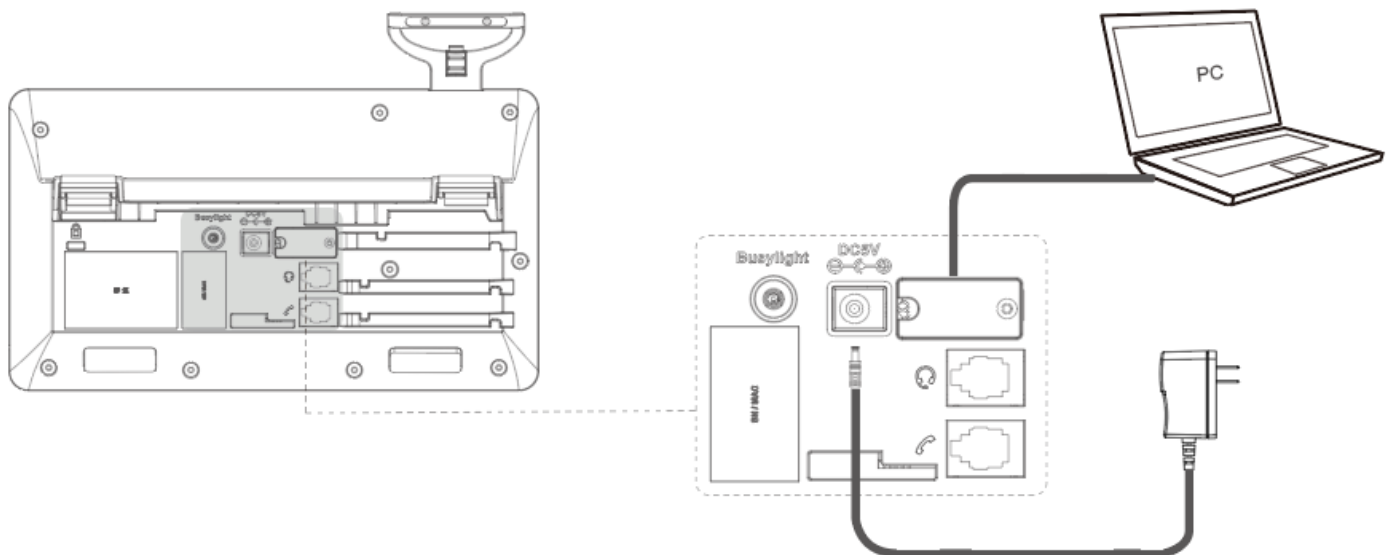

NOTE

-The phone should be worked with Yealink original power adapter (12V/1A) only. The third party power adapter may damage the phone.

-You can also connect to PC via Bluetooth, as shown in the Bluetooth Connection section.









FAQ

If you encounter a problem or can not complete an action, use [Troubleshooting](#) to identify and resolve the problem.

Call Control





MP50 Call Control

Basic Calls

Function	Action
Place a new call	<ul style="list-style-type: none"> - Tap the connected device CARD or . - Enter the desired number. - Select the desired outgoing dialing device. - Tap Call.
Answer call	Tap  .
End call	Tap  .
Reject call	Tap  .
Hold call	Tap  .
Resume call	Tap Resume .
Mute/un-mute microphone	Tap  /  on the screen or press the MUTE key.
Place a new call during a call	Tap  .

Multiple Calls



The phone can accept and handle multiple calls at the same time.

Function	Action
End the current call and answer the incoming call	Tap  and then tap  .
Put the current call on hold and answer the incoming call	Tap  on the phone.
Switch between held call and active call	Tap  on the phone.
Reject incoming call while on a current call	Tap  on the phone.

Merge Two Calls

You can merge two calls into one conference call.

Before you begin: There are two calls on the phone, and one of them is on the connected USB device.

1. Tap  > **Merge Calls**.
2. To split the conference, tap  > **Split Conf**.

Adjust Playback Volume

Do one of the following to adjust MP50 volume:

- Press the Volume key.
- Tap  or the user account avatar.

Go to **Settings > Basic Settings > Speaker Volume**.

Tap the desired value.

FAQ

TIP

If you encounter a problem or can not complete an action, use [Troubleshooting](#) to identify and resolve the problem.

Update

Update Firmware

What Is Firmware

Firmware is product software that controls how a device operates. To ensure your device performs optimally, we recommend updating the firmware to **the latest version**. Please go to the product support page to download the available firmware.

Check Firmware Version

Before you begin

We recommend you upgrade Yealink USB Connect to the latest version.

Download the [Yealink USB Connect](#).

Procedure

1. Run **Yealink USB Connect**.
2. Go to **Device status** to check the firmware version.

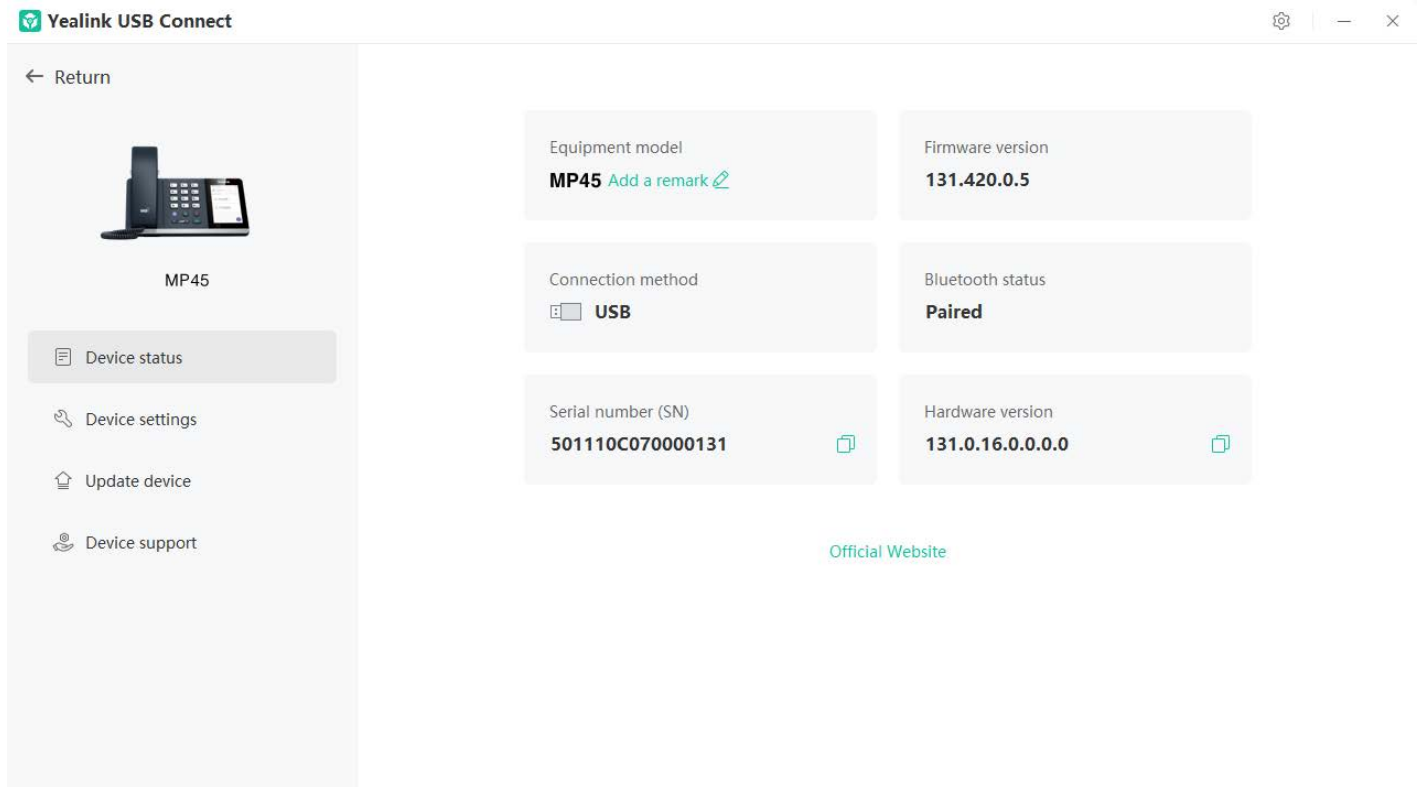

The screenshot displays the 'Yealink USB Connect' application window. On the left, a sidebar menu includes 'Return', 'MP45' (with a phone icon), 'Device status', 'Device settings', 'Update device', and 'Device support'. The main area shows the 'Device status' for the MP45 phone. It lists the following information:

Equipment model	MP45 Add a remark	Firmware version	131.420.0.5
Connection method	<input type="checkbox"/> USB	Bluetooth status	Paired
Serial number (SN)	501110C070000131 Copy	Hardware version	131.0.16.0.0.0.0 Copy

At the bottom right of the main area, there is a link for [Official Website](#).

For more information on Yealink USB Connect, refer to the [Yealink USB Device Manager Client User Guide](#).

Update via Yealink USB Connect

Before you begin

We recommend you upgrade Yealink USB Connect to the latest version.

Download the [Yealink USB Connect](#).

Download the latest [USB Phone Firmware](#).

Procedure

1. Connect the device to the PC via the USB cable.
2. Run **Yealink USB Connect**.
3. Go to **Update device**.
4. Do one of the following:
 - Click **Update Now** to update the firmware to the newest version automatically.
 - Click **Update Manually** to update the firmware to the specific version manually.



5. Confirm the action.

You need to download the firmware on the product documentation page first.

Update via YMCS/YDMP

Procedure

1. Enter the web user interface of the Yealink Management Cloud Service (YMCS)/Yealink Device management platform(YDMP).
2. Go to **Device Management > USB Device** to select the corresponding device, and click .

Device ID	Model	Device Name	Host IP	Firmware Version	Status	Operati...
508000C072400...	WH62	YL1425-A04705PC	10.86.3.55	104.420.0.35	Offline	
506010C110000...	UVC20	YL2264-A04338PC	10.82.22.20	257.410.254.139	Offline	
88008191190001...	CP900	YL2264-A04338PC	10.82.22.78	100.420.0.47	Offline	

3. Click **Update Firmware** to select version and execution mode.

Firmware Upgrade ×

Note: After update, the current firmware will be overwritten

Model:
 WH62

Version source:
 Official Version Custom Version

* Select Version:

WH62:

Execution Mode
 At once Timing

- 104.435.0.10
- 104.435.0.5
- 104.434.0.25
- 104.433.0.25
- 104.433.0.10
- 104.432.0.15

4. Click **OK**.

FAQ

TIP

If you encounter a problem or can not complete an action, use [Troubleshooting](#) to identify and resolve the problem.

Failed to update the device firmware.

Update Multiple Phones

Introduction

You can use the Yealink USB Connect to upgrade the same model of devices in bulk. Bulk updates require at least two devices of the same model to be connected, and up to six can be connected.

Bulk Update

1. Connect more than two devices to the PC.

Download the latest [Wired Headset Firmware](#).

TIP

If the PC does not have enough ports, you can use a USB extender to connect the device to the PC.

2. Open the [Yealink USB Connect](#) software and select the desired device CARD.

3. Go to **Update device > Update Manually**.

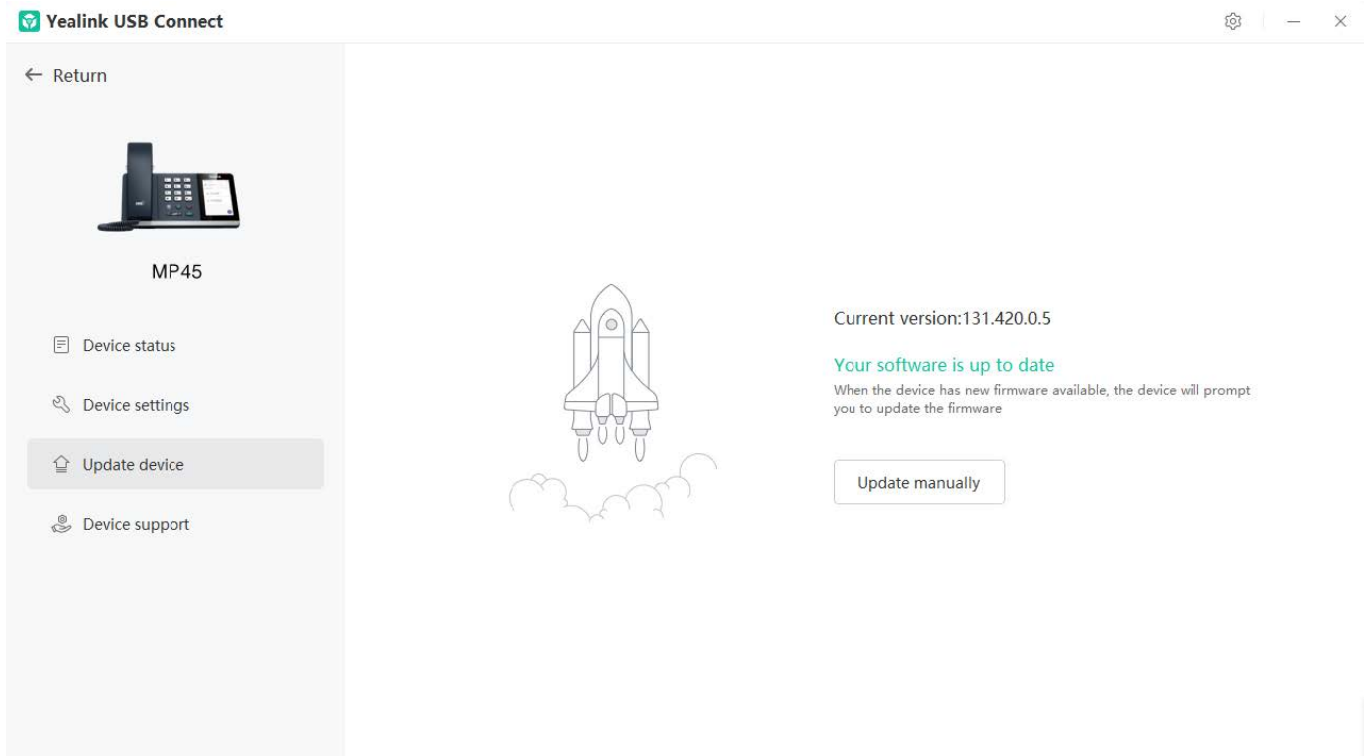

4. Click **Select all** to update all devices.

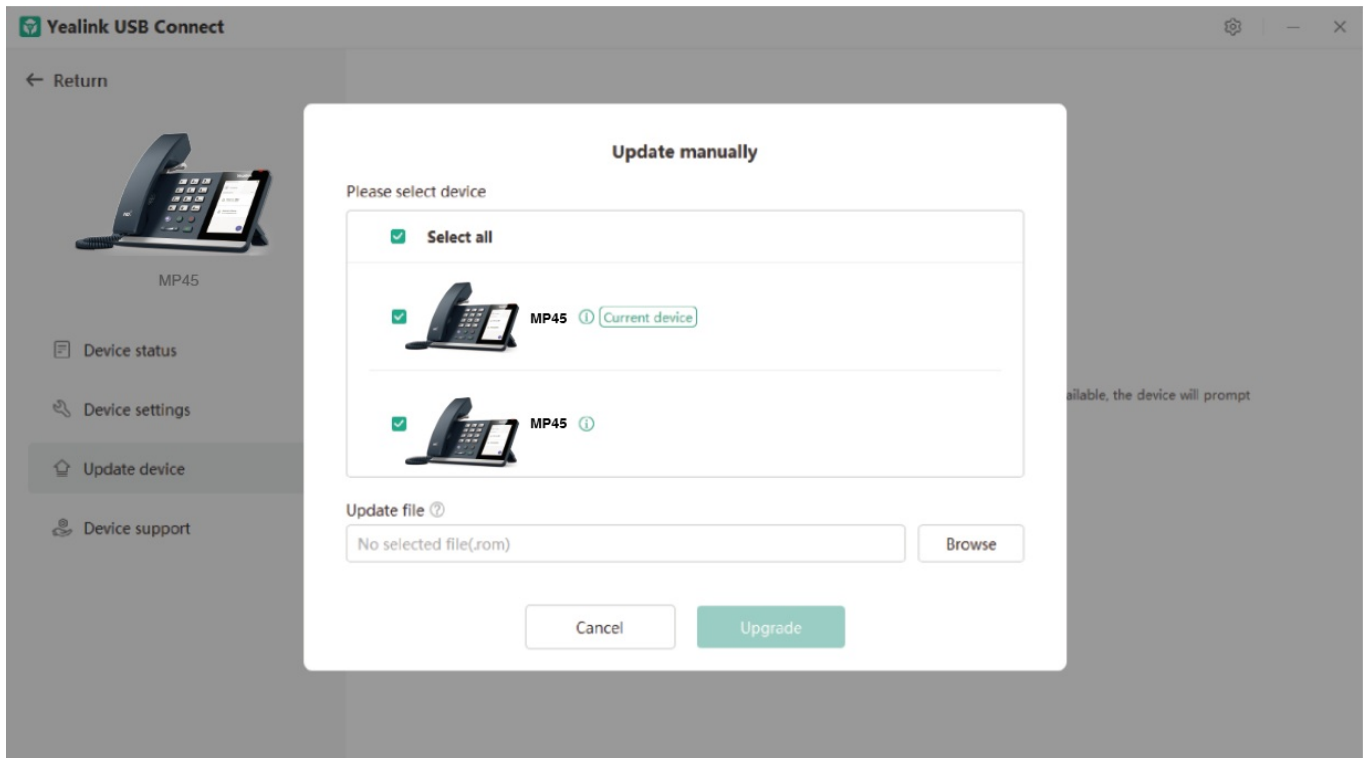

FAQ

TIP

If you encounter a problem or can not complete an action, use [Troubleshooting](#) to identify and resolve the problem.

[Failed to update the device firmware.](#)

Settings

Yealink USB Connect for USB Phone

Introduction

Yealink USB Connect is a computer software designed to manage Yealink USB devices.

With Yealink USB Connect, you can:

- Get an overview of connected Yealink USB devices

- Manage your Yealink USB devices
- Update your Yealink USB device to enhance its performance and features
- Give feedback on your Yealink USB device

The screenshot shows the 'Yealink USB Connect' application window. On the left is a sidebar with a 'Return' button and a list of options: 'Device status', 'Device settings', 'Update device', and 'Device support'. The main area displays the device 'MP45' with an image. To the right, there are six information cards: 'Equipment model' (MP45 with a remark icon), 'Firmware version' (131.420.0.5), 'Connection method' (USB), 'Bluetooth status' (Paired), 'Serial number (SN)' (501110C070000131 with a copy icon), and 'Hardware version' (131.0.16.0.0.0.0 with a copy icon). At the bottom right, there is a link for 'Official Website'.

Download via support.yealink.com

Download and Install

Before you begin

Connect the base to your PC.

1. If it is the first time to connect the base to your PC, the PC prompts you as shown below:

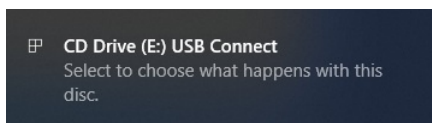

2. Click the prompt box and run the program.

CD Drive (E:) USB Connect

Choose what to do with this disc.

Install or run program from your media

 Run wscript.exe
Published by Microsoft Windows

Other choices

 Open folder to view files
File Explorer

 Take no action

3. Download the Yealink USB Connect on the web page.

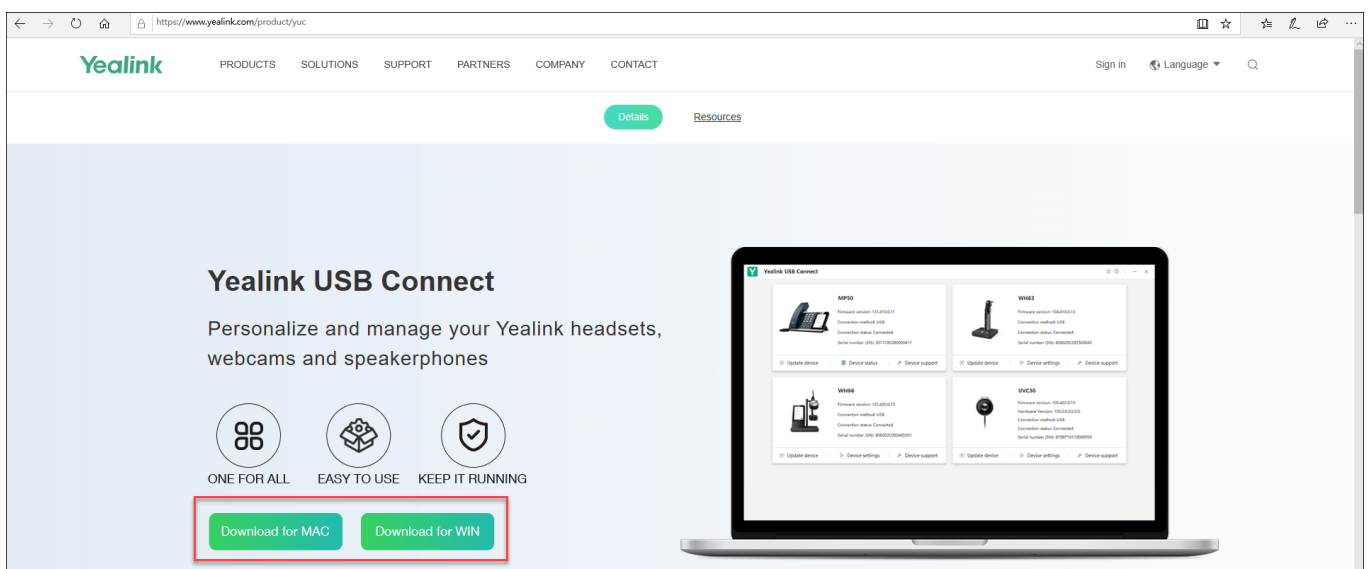

If the prompt box disappears, you can double-click the **CD drive: USB Connect** in the devices and drives list.

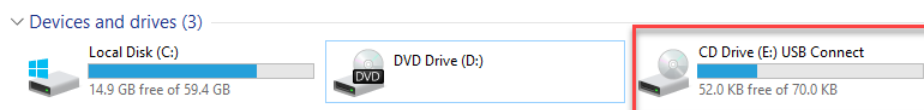

NOTE

If it detects that Yealink USB Connect has been installed after connecting, Yealink USB Connect will automatically run.

Related Video

- [How to use Yealink USB Connect](#)

FAQ

How to update the firmware?

Yealink USB Connect can't recognize device.

Settings

Change Default Outgoing Dialer Device

Change Default Outgoing Dialer Device

When multiple devices are connected to the phone, you can select the default outgoing dialer device.

1. Tap  on the idle screen.
2. Tap the desired connected device.

NOTE

It is only applicable to MP50.

FAQ

If you encounter a problem or can not complete an action, use [Troubleshooting](#) to identify and resolve the problem.

Change Default Media Playback Device

Change Default Media Playback Device

When there are multiple devices connected to the phone, you can change the default music playback device.

1. Tap  on the idle screen.
2. Tap the desired connected device.

NOTE

It is only applicable to MP50.

FAQ

If you encounter a problem or can not complete an action, use [Troubleshooting](#) to identify and resolve the problem.

Basic Settings

General Settings

- In the Phone

Go to **Settings > Basic Settings > General**.

- In the Yealink USB Connect

1. Open the [Yealink USB Connect](#) software and select the desired device CARD.
2. Go to **Device settings > Basic Settings > General**.

Functions	Description
Language	Select the screen text language from a list of 15 languages.
Time&Date	<p>Set the time and date manually.</p> <ul style="list-style-type: none"> · Time Format: 12 Hour/24 Hour can be selected on the device. <p>Default: 24 Hour.</p> <ul style="list-style-type: none"> · Date Format: Day, Month/Month, Day can be selected on the device. <p>Default: Month, Day.</p> <ul style="list-style-type: none"> · Manual Time: Enable this function to set the date and time manually.
Busylight	<p>Set the busylight status or turn off the busylight.</p> <ul style="list-style-type: none"> · Sync (the status depends on the softphone Presence status) · Available (LED glows green when the device is not in a call or not ringing) · DND (LED glows red when the device is not in a call or not ringing) · Off (LED is off) <div style="background-color: #f0e6ff; padding: 10px; margin-top: 10px;"> <p>NOTE It appears only when you connect the Busylight BLT60 to the phone.</p> </div>

Display Settings

- In the Phone

Go to **Settings > Basic Settings > Display**.

- In the Yealink USB Connect

1. Open the [Yealink USB Connect](#) software and select the desired device CARD.
2. Go to **Device settings > Basic Settings > Display**.

Functions	Description
-----------	-------------

Backlight/Backlight Active Level	Set the backlight active level and backlight time.
Screensaver	Change the waiting time for the screen saver.
Teams User Name	Configure whether the Teams user name displays on the home screen when the device disconnects with PC. <ul style="list-style-type: none"> · Personal Mode (default): Display the Teams user name when the device disconnects with PC. · Hot Desking Mode: Do not display the Teams user name when the device disconnects with PC.
Dark Theme	Turn on/off dark theme. The dark theme changes the default bright background color to a darker color, which is easier on the eyes in low-light environments or if you prefer less bright screens.
Screensaver Wait Time	Change the waiting time for the screen saver.
Screensaver Background	Set whether to display the built-in or the custom screensaver.

Sound Settings

- In the Phone

Go to **Settings > Basic Settings > Sound**.

- In the Yealink USB Connect

1. Open the [Yealink USB Connect](#) software and select the desired device CARD.
2. Go to **Device settings > Basic Settings > Sound**.

Functions	Description
Ring Tones	Enable/disable the phone to play a built-in tone while receiving an incoming call.
Dial Tone	Enable/disable the paired headset to play a dial tone when entering the dialing screen.
Keypad Tone	Enable/disable the paired headset to produce a sound when pressing the keypad keys.
Speaker Volume	Adjust the playback volume.

FAQ

TIP

If you encounter a problem or can not complete an action, use [Troubleshooting](#) to identify and resolve the problem.

Advanced Settings

General Settings

- In the Phone

Go to **Settings > Basic Settings > General**.

- In the Yealink USB Connect

1. Open the [Yealink USB Connect](#) software and select the desired device CARD.
2. Go to **Device settings > Advanced Settings > General**.

Functions	Description
USB Computer Audio	<p>This setting determines when your headset receives audio from a connected PC.</p> <p>Default: Instant.</p> <ul style="list-style-type: none"> · Instant: To have the audio (not call audio) turned on instantly. · Delayed: To have the audio (not call audio) turned on automatically with a brief delay. The delay will filter out short notifications sounds from the PC. · Never: To never have audio (not call audio) in the headset. · Always: to always have audio in the headset, this will affect the battery life.

Calling Settings

- In the Phone

Go to **Settings > Basic Settings > Calling**.

- In the Yealink USB Connect

1. Open the [Yealink USB Connect](#) software and select the desired device CARD.
2. Go to **Device settings > Advanced Settings > Calling**.

Functions	Description
Auto Dial	Enable/disable the phone to automatically dial the entered number within 5 seconds.
Call Device	Select which device to use for outgoing call.
Call Priority	<p>Select which call takes priority when a second call is accepted.</p> <ul style="list-style-type: none"> · New call: The first call is placed on hold and the new call is active. · Current call: The first call is active and the new call is placed on hold.
Call Recording	<p>Enable/disable calls from mobile devices or desk phones to be recorded on your PC. The supplied USB cable needs to be connected between the base and the PC, and additional recording software is required.</p> <p>Default: Off.</p>
Comfort Noise	To indicate to the other party that you are on a call by the weak and comfortable noise.

Noise Suppression	If enabled, it will suppress the background noise of the sender and improve the signal-to- ratio.
Smart Noise Block	Enable/disable the base to block out/eliminate the noises when in a call. When you make a call via speaker mode, enable this function can block out/eliminate the noises when there is no speech in a call.
Acoustic Shield Mode	Set the noise suppression feature of the headset and handset.
Acoustic Shield Level	Set the noise suppression level of the headset and handset.

FAQ

TIP

If you encounter a problem or can not complete an action, use [Troubleshooting](#) to identify and resolve the problem.

Restore Factory Settings

Restore Factory Settings

The following takes MP50 as an example.

1. Open the Yealink USB Connect software and select the desired device CARD.
2. Go to **Device settings > Device support**.
3. Select **Restore Factory Settings**.

Yealink USB Connect



← Return



MP45

☰ Device status

🔍 Device settings

🏠 Update device

📞 Device support

Log file collection

Real-Time Log



Logging level ⓘ

5 ▾

📄 Log file collection

📤 Upload log file

Feedback

✍️ Device feedback

🛠️ Maintenance application

📄 More support

Device recovery

🔄 Reboot device

FAQ

💡 TIP

If you encounter a problem or can not complete an action, use [Troubleshooting](#) to identify and resolve the problem.

Reset Configuration

Reset Configuration

1. Do one of the following:

- Tap or the user account avatar.

Go to **Settings > Advanced Settings > Reset Configuration**.

- Press and hold the pound key (#) and the star key (*) for about 6 seconds when the phone is idle.

The screen prompts you whether to reset the configuration or not.

2. Confirm the action.

Results

The phone will reboot and all settings will return to their default values.

FAQ

TIP

If you encounter a problem or can not complete an action, use [Troubleshooting](#) to identify and resolve the problem.

Bind Devices to YMCS Platform

Bind Devices to YMCS Platform

Introduction

Yealink Management Cloud Service (YMCS) is based on cloud architecture and has various management functions. The management platform allows enterprise administrators to deploy and configure Yealink devices used in an enterprise.

Enter the address of YMCS (<https://ymcs.yealink.com>) in the browser. For more information, please refer to [Yealink Management Cloud Service](#) or contact Yealink technical support.

Browser Requirements

YMCS supports the following browsers:

Browser	Version
Firefox	55 or later
Chrome	55 or later
Internet Explorer	11 or later
Safari	10 or later

How to Bind

You can refer to the video to bind your devices.



The video could not be loaded

Service & Repair

Introduction

How to Report the Issue to Yealink?

For headset issues, click the link below and fill out the form. Next, you can open up the Yealink USB connect to get your firmware version. Then type a description of your problem and submit it. It will then ask for your contact information, including your email address. Yealink will typically respond within 24 hours.

<https://ticket.yealink.com/page/create-ask.html>

How to Collect Diagnostic Files?

Yealink Bluetooth headsets support analyzing the headset problem. You can export these files simultaneously via Yealink USB Connect Tool and troubleshoot if necessary. The diagnostic file format is **.zip

Steps:

1. Go to **Device support** > **Log file collection** > **Collect file collection** on the Yealink USB Connect.

2. Click **Collect the operating system logs > Export.**

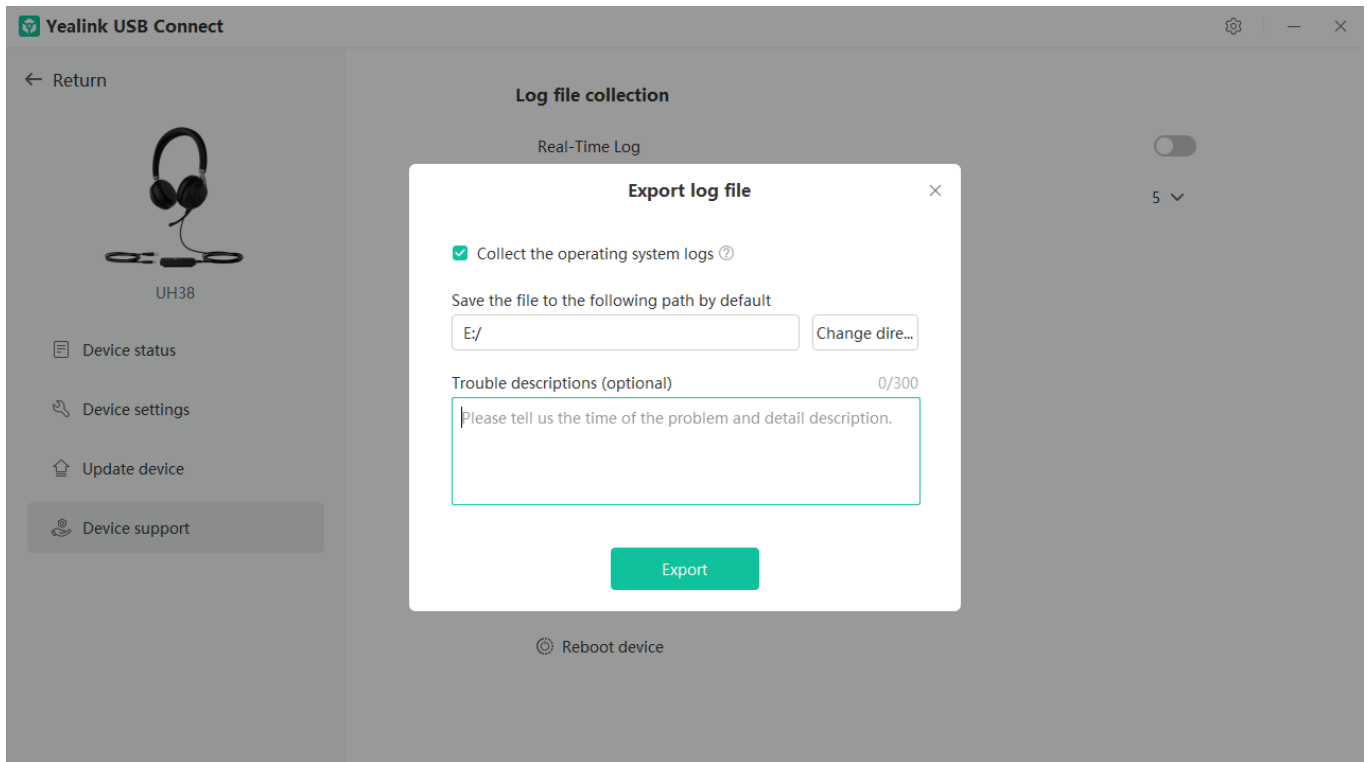

Here is the FAQ for more details.

<https://support.yealink.com/en/portal/knowledge/show?id=0be9481fbb00a3c9a4d210a9>

Related Topic

- [Reproduce Issues](#)
- [New Feature Request](#)

Reproduce Issues

Detailed Issue Description

** [Headset type and version] + [connected device info, how to connect the device to Base, and how many?]*

** Steps to reproduce the issue.*

** Probability of this issue? Inevitable or accidental?*

** Is there any other information you want to share? Any troubleshooting you have done?*

Reproduce the Issue

1. Make an audio call, go to **Device support > Log file collection** to select **Collect operating system logs** on the Yealink USB Connect.

NOTE

- Before using, please connect the base and headset to the PC via a USB cable first.
- Before exporting the log file, please select log level 6 or 7 first.

The screenshot shows the 'Yealink USB Connect' application window. On the left is a sidebar with a 'Return' button and a headset icon labeled 'UH38'. Below the icon are menu items: 'Device status', 'Device settings', 'Update device', and 'Device support'. The main content area is titled 'Log file collection' and includes a 'Real-Time Log' toggle switch (currently off), a 'Logging level' dropdown menu (set to 5), and an 'Upload log file' button. Below this is a 'Feedback' section with 'Device feedback', 'Maintenance application', and 'More support' options. At the bottom is a 'Device recovery' section with a 'Reboot device' button. The 'Logging level' dropdown menu is open, showing options 1 through 6, with option 5 selected and a checkmark.

2. Click Export.

This screenshot shows the same application window as above, but with an 'Export log file' dialog box open in the center. The dialog has a close button (X) in the top right corner. It contains a checked checkbox for 'Collect the operating system logs'. Below this is a text input field for the save path, currently containing 'E:/', with a 'Change dire...' button to its right. There is also a 'Trouble descriptions (optional)' section with a character count of '0/300' and a text area containing the placeholder text 'Please tell us the time of the problem and detail description.'. At the bottom of the dialog is a green 'Export' button. The background application window is dimmed.

3. Then go to the path to get the diagnostic file (with a **.zip format).

Get Troubleshooting Files

[Create a ticket](#) to Yealink with: Issue description, and diagnostic files (with a **.zip format).

New Feature Request

[Create a Ticket](#) to Yealink with for New Feature Request:

Please describe the detailed description of this new feature for us below:

**Application scenario*

**How does this function work? Why does the customer need it?*

**Do any other brand headsets support this feature?*

**Any business/project information?*

USB Phone Troubleshooting

What can I do to solve a problem

If the phone does not function as expected, try the following steps to resolve the issue.

- Find the symptoms of the issue in this Worklink, and try any corrective actions listed.
- Restart the device that is being connected to the phone.
You may resolve some issues by restarting the connected device such as your PC or mobile device (MP50).
- Reset the phone.
- Initialize the phone.
This operation resets volume settings, etc., to the factory settings, and deletes all pairing information.
- Look up information on the issue on the [Yealink Ticket](#) or [Yealink Support](#) website.

If the operations above do not work, consult your nearest dealer or go to [Yealink Ticket](#) or [Yealink Support](#) for feedback your issue.

Power & Charge

Unable to power on the headset

- Make sure the battery is fully charged.
- Reset the headset.
- Initialize the headset, and pair the headset and the device again (MP50).

The headset is powered off automatically

Make sure the battery is fully charged.

Charging cannot be done

Common

- Try charging with the supplied USB cable.
- We recommend you charge in a place with an ambient temperature between 32 °C and 104 °C. Efficient charging may not be possible beyond this range.
- Reset the headset.
- Initialize the headset, and pair the headset and the device again.

When charging with a USB AC adapter

- Ensure the USB AC adapter is firmly connected to the AC outlet.
- When using a commercially available USB AC adapter, use one capable of supplying an output current of 1.5 A or more.

When charging with a PC

- Check the supplied USB Type-C cable is properly connected to the PC's USB port.
- Check the PC is turned on.
- There may be a problem with the USB port of the connected PC. Try connecting to another USB port on the PC if one is available.
- Restart the PC and try the USB connection procedure again in cases other than those stated above.

Charging time is too long

- When charging with a PC, check that the headset and the PC are directly connected, and not via a USB hub.
- Check that you are using a commercially available USB AC adapter capable of supplying an output current of 1.5 A or more.
- Check that you are using the supplied USB Type-C cable.
- We recommend you charge in a place with an ambient temperature between 32 °C and 104 °C. Efficient charging may not be possible beyond this range.
- Restart the PC and try the USB connection procedure again in cases other than those stated above.

Sound

No sound

- Check that both the headset and the connected device are turned on.

- When playing music, check that the headset and the transmitting device are connected.
- When using a video calling application on a PC, check that the headset and the PC are connected. Depending on the video calling application you are using, microphone settings may not be available.
- When you connect with 2 devices simultaneously with a multipoint connection, depending on the connected device, the device may keep sending the silent signal even if the playback of the music or video is stopped. In this case, the headset remains connected to the device, and the connection may not be changed to another device. If the sound from the second device cannot be heard after the playback is stopped on the first device, operate in the following order and check whether the situation has improved.
 - Stop the playback of the application on the first device.
 - Shut down the application on the first device.
- Turn up the volume if it is too low.
- Check that the connected device is playing back.
- If you are connecting a PC to the headset, make sure the audio output setting of the PC is set for a Bluetooth device.
- Pair the headset and the Bluetooth device again.
- Restart the smartphone or the PC you use.
- Reset the headset.
- Initialize the headset, and pair the headset and the device again.

Low sound level

- Turn up the volume of the headset and the connected device.
- Connect the Bluetooth device to the headset once again.
- Reset the headset.
- Initialize the headset, and pair the headset and the device again.

NOTE

Depending on the connected device, the volume of the device and the headset may or may not be synced. If the volume on a device is not synced to the volume on the headset, it will not be possible to use the device to turn up the volume on the headset once the volume is turned down on the headset. In that case, turn up the volume of both the headset and the connected device.

Low sound quality, or noise sound can be heard

- Turn down the volume of the connected device if it is too loud.
- Some devices that emit ultrasonic sound waves designed to repel rodents may occasionally be installed at the entrances of commercial facilities or subway stations. Near such devices, the ultrasonic sound waves may cause noise or unusual sounds to be heard from the headset. Leave the place where the noise or unusual sound is heard. Or turn off the noise canceling mode from the Yealink USB Connect software.
- If the headset connects to the previously connected Bluetooth device, the headset may only establish the HFP/HSP Bluetooth connection when it is turned on. Use the connected device to connect via an A2DP Bluetooth connection.

- When listening to music from a PC on the headset, the sound quality may be poor (e.g., difficult to hear the callee voice, etc.) for the first few seconds after a connection is established. This is due to the PC specifications (priority on stable connection at the start of transmission and then switches to priority on sound quality several seconds later) and is not a headset malfunction.

Sound skips frequently

Communications may be disabled, or noise or audio dropout may occur under the following conditions.

- When there is an obstacle, such as metal or a wall, between the headset and the Bluetooth device
- In places with wireless LAN, where a microwave oven is used, electromagnetic waves are generated, etc.
- Where there are other wireless communication audio devices or other people nearby, such as in train station premises or on a crowded train
- If you are enjoying music with your smartphone, the situation may be improved by closing unnecessary apps or restarting your smartphone. If you are enjoying music with your computer, close unnecessary applications or windows and restart the computer.
- Connect the headset and the Bluetooth device once again.
- Reset the headset.
- Initialize the headset, and pair the headset and the device again.

Noise canceling effect is not sufficient

- Make sure the noise canceling function is turned on.
- Adjust the headset to a comfortable position.
- The noise canceling function is effective in low-frequency ranges such as airplanes, trains, offices, near air-conditioning, and is not as effective for higher frequencies, such as human voices.
- With the Yealink USB Connect, check the setting of **Smart Noise Block**. If you enable **Smart Noise Block**, the effect of noise canceling is reduced. You should enable **Noise Suppression**.

Connect

NOTE

It is only applicable to MP50.

Pairing cannot be done

- Bring the headset and the Bluetooth device within 1 m (3 feet) from each other.

- When pairing a device for the first time after purchase or after initializing or repairing the headset, turn on the headset and put the headset enter pairing mode. To pair a second or subsequent device, press and hold **Call Control** button on the headset for about 5 seconds to enter pairing mode.
- When pairing a device once again after initializing or repairing the headset, you may be unable to pair it if it retains pairing information for the headset (smartphone or other devices). In this case, delete the pairing information for the headset from the device and pair them again.
- Restart the connected device such as a smartphone or a PC you use, and pair the headset and the device again.
- Reset the headset.
- Initialize the headset, and pair the headset and the device again.

Unable to make a Bluetooth connection

- Check that the headset is turned on.
- Check that the Bluetooth device is turned on and the Bluetooth function is on.
- If the headset automatically connects to the last connected Bluetooth device, you may fail to connect the headset to other devices via Bluetooth connection. If this is the case, operate the last connected Bluetooth device and disconnect the Bluetooth connection.
- Check if the Bluetooth device is in sleep mode. If the device is in sleep mode, cancel the sleep mode.
- Check if the Bluetooth connection has been terminated. If terminated, make the Bluetooth connection again.
- If the pairing information for the headset has been deleted on the Bluetooth device, pair the headset with the device again.
- Reset the headset.
- Initialize the headset, and pair the headset and the device again.

Update

If any of these messages appear during the software update, follow the instructions provided to continue with the update.

Possible Causes

If any of the issues above occur, the following conditions might cause the update to stop before it completes.

- The headset and mobile device have an unstable connection.
- The headset or mobile device has a low battery.
- There is signal interference, such as from a wireless LAN or other wireless devices (Only MP50).

Troubleshoot Issue

- Turn off power to all devices connected to the mobile device being used for the update.
- Turn off the mobile device. Then turn it back on.
- Close the Yealink USB Connect.
- Open the Yealink USB Connect again.

- Fully charge your headset and mobile device.
- Initialize the headset, and pair the headset and the device again (Only MP50).
- Unplug and plug the headset via a USB cable.

Perform Update Again

Check the following conditions first and then perform the update again using the or Yealink USB Connect.

- Turn off or close all other apps running on the mobile device/PC.
- Keep the headset as close to the mobile device as possible (Only MP50).
- Keep other devices that transmit radio waves, including Bluetooth and Wi-Fi® devices, away from the headset and the mobile device (Only MP50).
- When using an iOS device (iPhone, iPad, etc.), turn off the Google Assistant settings (Only MP50).

Clean

Please follow these hygiene practices and keep your products clean.

1. Rub the cloth with a bit of regular soap and water, and dry the excess liquid to prevent the fabric from dripping. Use only soap and water - do not use a strong cleaner.
2. Gently wipe the phone to ensure no foam on the surface.
3. Leave the phone for at least one minute.
4. Wipe the surface with a slightly damp cloth (water only).
5. Dry in the air.
6. If you do not use the phone, avoid contact with dirty surfaces to keep it clean. If the phone comes with a charging cradle, you can insert it into the cradle or place it in a protective case/bag.