

Yealink

Teams Phone

User Guide

VP59

MP58

MP56

MP54

MP52

CP960

CP965

MOMENTUM

Perform Teams Call Operations

Switch among Handset, Speakerphone and Headset Modes

You can make and receive calls on your phone using the handset, headset, or speakerphone. During calls, you can switch between these three modes if they are available.

Procedure









1. Do one of the following:
 - Pick up the handset to use the handset mode.
 - Press the Speakerphone key to use the speakerphone mode. The key LED glows green.
 - Press the HEADSET key to use the headset mode. The key LED glows green.

Place Calls

Call Contacts

Procedure

1. Select the method according to your device:

VP59/MP58/MP56/MP54/CP965	MP52
<ol style="list-style-type: none"> 1. From the Calls screen, tap  ( for CP965). 2. Enter the contact account information to search for the desired contact. 3. Tap  beside the contact to place an audio call. For VP59, tap  beside the contact to place a video call. 	<ul style="list-style-type: none"> ○ From the Calls screen, select  beside the contact or  key. ○ From the VOICEMAIL screen, select the voicemail record that you want to call, and select . ○ From the PEOPLE screen, select the desired contact, and select  key.



TIP

For VP59/MP58/MP56/MP54/CP965, you can tap  to search for a contact.



Dial a Number

Procedure

1. Select the method according to your device:

VP59/MP58/MP56/MP54	CP965	MP52
<ul style="list-style-type: none"> ○ Pick up the handset. ○ Press the Speakerphone key. ○ Press the HEADSET key. ○ Tap  on the Calls screen. 	Tap  from the Calls screen.	<ul style="list-style-type: none"> ○ Pick up the handset. ○ Press the Speakerphone key. ○ Press the HEADSET key. ○ Press the keypad.

2. Enter the contact number.
3. Select the method to dial the number according to your device:







VP59/MP58/MP56/MP54/CP965	MP52
Tap  beside the contact to place an audio call. For VP59, tap  beside the contact to place a video call.	Press the OK key.

Place Multiple Calls

You can hold your current call and place a new call when you are on a call. Only one active call (the call that has audio associated with it) can be in progress at any time.

Procedure

1. Select the method according to your device:

VP59/MP58/MP56/MP54/CP965	MP52
<ol style="list-style-type: none"> 1. During a call, tap  to return to the Calls screen. 2. Tap  (for CP965 ) on the Calls screen or tap  to search and then dial out the contact. 	<ol style="list-style-type: none"> 1. During a call, select  key to return to the VOICEMAIL screen. You can place the call directly if the people you want to call are in the voicemail record. 2. Select  to return to the home screen and choose the way to call contacts. The active call is placed on hold, and the new call is set up.

The active call is placed on hold, and the new call is set up.

Place a Call from Call History

You can place calls to contacts from the call history list containing incoming, outgoing, and missed calls.

Procedure

1. Go to **Calls** > **RECENT** screen, select the desired contact.
2. Select  to place an audio call.

For MP52, press the OK key.

For VP59, tap  beside the contact to place a video call.

Redial a Number

You can recall the last contact you called when your phone is idle.



Procedure

1. Press the REDIAL key  (the REDIAL key is unavailable to MP54/CP965).

Place a Call from Voicemail

Procedure

1. Select the method according to your device:



VP59/MP58/MP56/MP54/CP965	MP52
<ol style="list-style-type: none"> 1. From the Voicemail screen, select the voicemail record that you want to call. 2. Select  to place an audio call. For VP59, tap  beside the contact to place a video call. 	<ol style="list-style-type: none"> 1. From the Voicemail screen, select the voicemail record that you want to call. 2. Press the OK key. 3. Select  to place an audio call.

Place an Emergency Call from a Locked Phone

Once the phone is locked, you can dial an emergency number without having to unlock it.

Procedure

1. Select the method according to your device:

VP59/MP58/MP56/MP54	CP965	MP52
<ul style="list-style-type: none"> ○ Pick up the handset. ○ Press the Speakerphone key. ○ Press the HEADSET key. ○ Tap  on the touch screen and select Emergency Call. 	<p>Tap  on the touch screen and select Emergency Call.</p>	<ul style="list-style-type: none"> ○ Pick up the handset. ○ Press the Speakerphone key. ○ Press the HEADSET key. ○ Press the keypad and select Emergency Call.

2. Enter an emergency number and select the call icon to place the call.

Auto Dial for Extension Dialing

Tenant admins can add dial plans for their organization with normalization rules to enable extension dialing in Teams. Teams phones will auto dial in 3 seconds after an approved extension is dialed by the user using the dial pad.

FAQ

[Why is the call dropped?](#)

[Why am I unable to call out?](#)

[Why can't I pick up the call?](#)

Answer, End, Or Reject Calls



Answer Calls

When you receive an incoming call on your phone, you can choose to answer it in various ways.

Answer a Call

Procedure

1. Select the method according to your device:



VP59/MP58/MP56/MP54/MP52	CP965
<ul style="list-style-type: none"> ○ Pick up the handset. ○ Press the Speakerphone key. ○ Press the HEADSET key. ○ For VP59/MP58/MP56/MP54: Tap  on the Calls screen. ○ For MP52: Select . 	<p>Tap  on the Calls screen.</p>

Answer a Call When on a Call

You can answer an incoming call when you are on an active call.

Procedure

1. Select the method according to your device:

VP59/MP58/MP56/MP54/CP965	MP52
<p>Tap  on the Calls screen.</p>	<p>Select .</p>

The active call is placed on hold, and the incoming call becomes active.

End or Reject an Active Call

Procedure

1. Select .

End All Calls in the Process

NOTE

This feature is only available to VP59/MP58/MP56/MP54/MP52.

Procedure

1. Do one of the following:
 - If you are using the handset, hang up the handset.
 - If you are using the headset, press the HEADSET key.
 - If you are using the speakerphone, press the Speakerphone key.

Merge Calls

You can merge the active call, and the held calls on your phone.

Procedure

1. During a call, go to  > **Merge with xx** (xx refers to the contact name).

TIP

If multiple calls are on hold, you can choose one to merge.

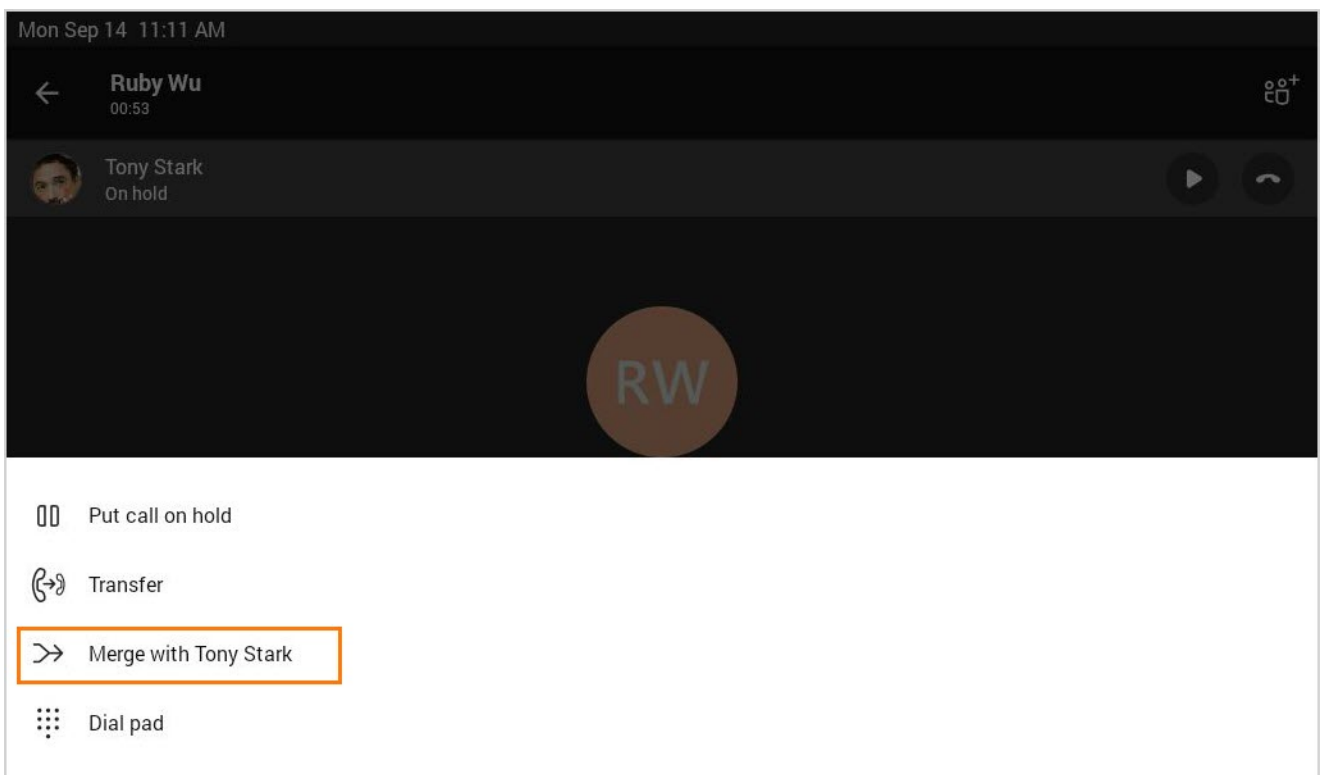

Transfer Calls

You can transfer a call to another party using the blind transfer or the consultative transfer method.

Perform a Blind Transfer

You can transfer calls to other contacts immediately without consulting with them first.

Procedure

1. Select the method according to your device:

VP59/MP58/MP56/MP54/CP965	MP52
<p>During a call, go to Transfer > Transfer now.</p> <p>For VP59/MP58/MP56, you can also press .</p>	<p>During a call, select  > Transfer now.</p>

The call is placed on hold.

2. Select the desired contact or search for a contact.

Then the call is connected to the contact to which you are transferring.





3. Select  to end the call, or it will end automatically when the other party picks up.

Perform a Consultative Transfer

You can transfer calls to other contacts after consulting with them first.

Procedure

1. Select the method according to your device:

VP59/MP58/MP56/MP54/CP965	MP52
<ol style="list-style-type: none"> 1. During a call, go to Transfer > Consult first. For VP59/MP58/MP56, you can also press . 2. Select the desired contact or search for a contact. 3. After the party answers the call, tap  beside the contact. 	<ol style="list-style-type: none"> 1. During a call, select  > Transfer > Consult first. 2. Select the desired contact or search for a contact. 3. After the party answers the call, select  > Transfer beside the contact.

It prompts you to transfer the call or not.

2. Select **OK** to complete the transfer.

After the transferred party answers the call, the call is transferred successfully.

Transfer a Call to the Work Voicemail

You can directly transfer a call to someone's work voicemail without ringing the far-end user. This allows them to leave voicemails for users without interrupting them discreetly.

NOTE

This feature is unavailable to MP52.

Procedure

1. During a call, tap  > **Transfer** > **Transfer now**. For VP59/MP58/MP56, you can also press .

The call is placed on hold.

2. Go to  > **Work voicemail**.

Forward Calls

You can set up your phone to forward all incoming calls to a specified destination.

Before You Begin

Make sure that the administrator has assigned Microsoft Phone System license to you.

Forward Calls to Voicemail

You can forward all incoming calls to your voicemail.

Procedure

1. Select the method according to your device:

VP59/MP58/MP56/MP54/CP965	MP52
Tap the account avatar and go to Settings > Calling .	Go to  > Settings > Calling .

2. Enable **Call forwarding**.

3. Go to the **Forward to** field and then select **Voicemail**.

Wed May 10 12:32 PM

← **Forward to**

- Voicemail
- Contact or number
- Call group
- My delegates



Forward Calls to a Contact or Number

You can forward all incoming calls to a contact or number.

Procedure

1. Select the method according to your device:

VP59/MP58/MP56/MP54/CP965	MP52
Tap the account avatar and go to Settings > Calling .	Go to  > Settings > Calling .

2. Enable **Call forwarding**.
3. Go to the **Forward to** field and then select **Contact or number**.

4. Add the desired number.

The incoming calls are automatically forwarded to the contact or number.

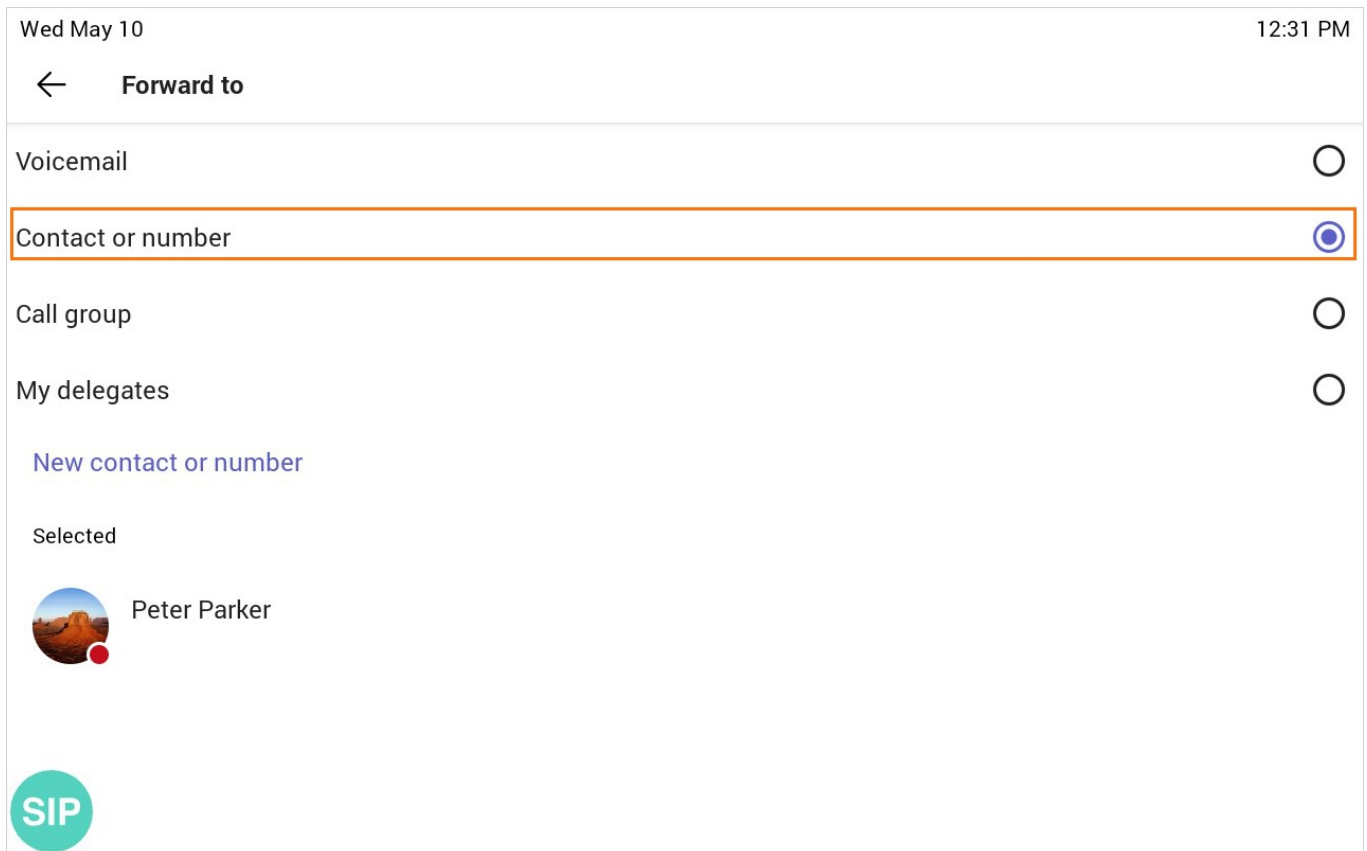

Forward All Incoming Calls to Delegates

You can forward all incoming calls directly to your delegates.

Before you begin

You have added contacts as your [delegate](#).

Procedure

1. Select the method according to your device:

VP59/MP58/MP56/MP54/CP965	MP52
Tap the account avatar and go to Settings > Calling .	Go to  Settings > Calling .

2. Enable **Call forwarding**.

3. Go to the **Forward to** filed and then select **My delegates**.

Wed May 10 12:34 PM

← **Forward to**

Voicemail

Contact or number

Call group

My delegates

My delegates



Peter Parker



Delegates are configurable via settings.

Forward Calls If Unanswered

You can configure the forwarded destination if the incoming call is not answered.

Procedure

1. Select the method according to your device:

VP59/MP58/MP56/MP54/CP965	MP52
Tap the account avatar and go to Settings > Calling > If unanswered.	Go to  Settings > Calling.

2. Select a desired forwarded destination.

Wed May 10 12:37 PM

← **If unanswered**

Voicemail

Contact or number

Call group

[New contact or number](#)

Selected

 Simon Yu

 Delegates are configurable via settings.



Hold or Resume Calls

When you are in a call, you can place an active audio call on hold and resume the call when you are ready.

Place a Call on Hold

Procedure

1. Select the method according to your device:



VP59/MP58/MP56/MP54/CP965	MP52
During a call, tap Hold . For VP59/MP58/MP56, you can also press  .	During a call, select  > Put call on hold .

Resume a Call



Procedure

1. Do one of the following:

- If only one call is placed on hold:

VP59/MP58/MP56/MP54/CP965	MP52
Tap Resume . For VP59/MP5X, you can also press  .	Select  .

- If multiple calls are placed on hold:

VP59/MP58/MP56/MP54/CP965	MP52
Tap  on the right side of the desired held call.	a. Select  b. Select  > Swap call .

Mute or Unmute Audio

You can mute the microphone during an active call so that the other party cannot hear you.

Mute

Procedure

1. During a call, select the method according to your device:

VP59/MP58/MP56/MP54/CP965	MP52
<ul style="list-style-type: none"> ○ Tap  on the touch screen. ○ Press the mute key on the phone. For CP965, tap the mute touch key on the phone. 	Press the mute key on the phone.

The mute key glows red.

Unmute

Procedure

1. During a call, select the method according to your device:

CP960/CP965	VP59/MP5X
<ul style="list-style-type: none"> ○ Tap  on the touch screen. ○ Press the mute key on the phone. For CP965, tap the mute touch key on the phone. 	Press the mute key on the phone.

The mute key glows green (for MP52, the mute key is off).

Synchronize Calls to Specified Contact or Delegate

You can synchronize incoming calls to a specified contact or delegate so that you and they can receive the incoming calls simultaneously.

NOTE

If you enable the [Call forwarding](#) feature, the **Also ring** feature will be unavailable.

Procedure

1. Select the method according to your device:

VP59/MP58/MP56/MP54/CP965	MP52
Tap the account avatar and go to Settings > Calling > Also ring .	Go to  > Settings > Calling > Also ring .

2. Select **Contact or number** and add the target contact.

The target member and you will receive the incoming calls simultaneously.

Park or Retrive Calls

Overview

The call park and retrieve feature allows users to place a call on hold in the Teams service in the cloud. When a call is parked, the service generates a unique code for call retrieval. The user who parked the call or someone else can use that code to retrieve the call.

NOTE

- If the call park and retrieve feature is unavailable, contact your administrator for more information.
- This feature is unavailable to MP52.

Park Teams Calls

If you want to receive the call on a mobile device instead of the desk phone for convenience, or if the caller wants someone else to answer, you can park the call on the Teams server. When a call is parked, you can use the code to

retrieve the call on another device.

If the parked call is not retrieved within five minutes, you will receive a ringback.

Procedure

1. During a call, go to  > **Park Call**.

The call is parked, and the code to retrieve the call is displayed on the phone.

Retrieve Parked Calls

After the call is parked, you can retrieve the call on another phone or provide another contact with the call retrieval code to retrieve the call.

Procedure

1. Tap  when the phone is idle.
2. Enter the code.



Pick up a parked call

Enter Code

Cancel OK

3. Tap **OK**.

Call Queue

A call queue is a feature that routes and queues incoming calls to group members, called agents, such as a help desk or a customer service desk.

When someone calls a phone number set with a call queue, they will hear a greeting first (if any is set up), and then they will be put in the queue and wait for the available call agent. The person calling in will hear music while they are placed on hold and waiting, and the call in the queue will ring all call agents at the same time by default. After a call agent accepts the call, other agents' phones stop ringing.

If you are assigned as an agent of the call queue, the incoming calls to the call queue will display the name of the call queue to distinguish it from common calls.

NOTE

- The routing method (**Attendant routing**, **Serial routing**, or **Round Robin**) is decided by your administrator.
- Make sure that your administrator has [set up the call queue feature](#).

Block Calls with No Caller IDs

Procedure

1. Select the method according to your device:

VP59/MP58/MP56/MP54/CP965	MP52
Tap the account avatar and go to Settings > Calling .	Go to  > Settings > Calling .

2. Enable **Block calls with no caller ID**.

If your phone is set as a common area phone, select the method according to your device:

VP59/MP58/MP56/MP54/CP965	MP52
Tap the account avatar and go to Settings > Device Settings > Calling (Admin only, default password: admin) to enable Block calls with no caller ID .	Go to  > Settings > Device Settings > Calling (Admin only, default password: admin) to enable Block calls with no caller ID .

Hide Your Phone Number (Anonymous Call)

You can hide your phone number when dialing people outside of Microsoft Teams.

Procedure

1. Select the method according to your device:

VP59/MP58/MP56/MP54/CP965	MP52
Tap the account avatar and go to Settings > Calling .	Go to  > Settings > Calling .

2. Enable **Hide your phone number when dialing people who are outside of Microsoft Teams**.

If your phone is set as a common area phone, select the method according to your device:

VP59/MP58/MP56/MP54/CP965	MP52
Tap the account avatar and go to Settings > Device Settings > Teams Admin Settings (Admin only, default password: admin) > Calling to enable Hide your phone number when dialing people who are outside of Microsoft Teams .	Go to  > Settings > Device Settings > Teams Admin Settings (Admin only, default password: admin) > Calling to enable Hide your phone number when dialing people who are outside of Microsoft Teams .

Pickup Group Calls

You can [accept/decline](#) incoming call notifications for call groups from anywhere on the phone.

Delegates

You can pick someone to be your delegate—to receive and make calls on your behalf. When you add a delegate, you're essentially sharing your phone line with them so that they can see and share all of your calls.

Teams phones provide the ability to set up and manage delegates.

Add a Delegate from Settings

Procedure

1. Select the method according to your device:

VP59/MP58/MP56/MP54/CP965	MP52
Tap the account avatar and go to Settings > Manage delegates .	Go to  > Settings > Manage delegates .

2. Type the person's name in the **Add a delegate** box and select your delegate.
3. Select the permission you want to give your delegate.

Sun Apr 23 5:44 AM

× **Peter Parker** ✓

Things this delegate can do on your behalf.

Calling

- 📞
Make calls
- 📞
Receive calls
- 📞
Change call and delegate settings



4. Save the change.

Your new delegate will now appear in your delegates list.

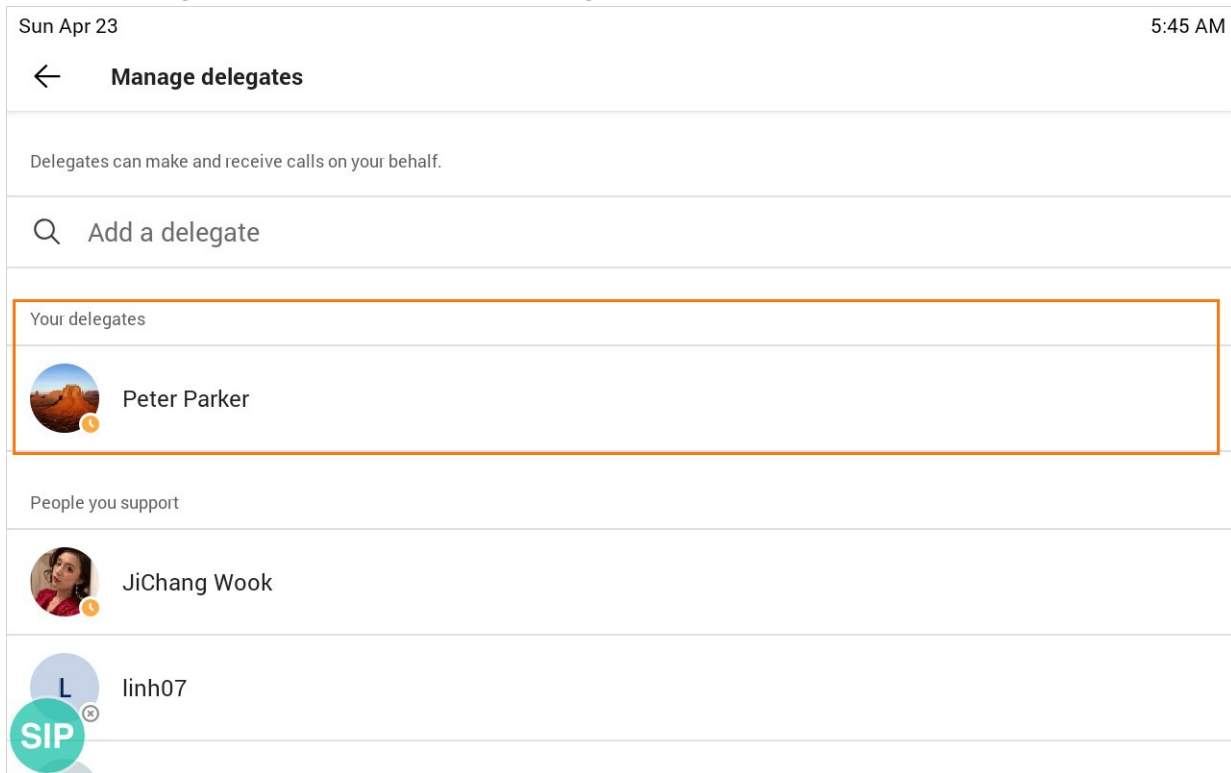

Forward All Incoming Calls to Delegates

You can forward all incoming calls directly to your delegates.

Procedure

1. Select the method according to your device:

VP59/MP58/MP56/MP54/CP965	MP52
Tap the account avatar and go to Settings > Calling .	Go to  > Settings > Calling .

2. Enable **Call forwarding**.

3. Select the **Forward to** filed and then select **My delegates**.



Related Topics

[Forward Calls](#)

Forward Incoming Calls to Delegates if Unanswered

You can handle unanswered calls to voicemail, your contacts, external phone number, or a call group.

Procedure

1. Select the method according to your device:

VP59/MP58/MP56/MP54/CP965	MP52
Tap the account avatar and go to Settings > Calling > If unanswered.	Go to  > Settings > Calling > If unanswered.

2. Select **My delegates**.

Sun Apr 23 5:51 AM

← **If unanswered**

Off

Voicemail

Contact or number

Call group

My delegates

My delegates



Peter Parker



Related Topics

[Forward Calls](#)

Synchronize Incoming Calls to Delegates

You can synchronize incoming calls to delegates so that you and your delegates can receive the incoming calls simultaneously.

NOTE

If you enable the [Call forwarding](#) feature, the **Also ring** feature will be unavailable.

Procedure

1. Select the method according to your device:

CP965	VP59/MP5X/CP960
Tap the account avatar in the top-right corner of the screen and go to Settings > Calling > Also ring .	Go to  > Settings > Calling > Also ring .

2. Select **My delegates**.

Boss-Admin Delegates

Call on Behalf Of

The delegate can place a call either on their behalf or on behalf of the boss.

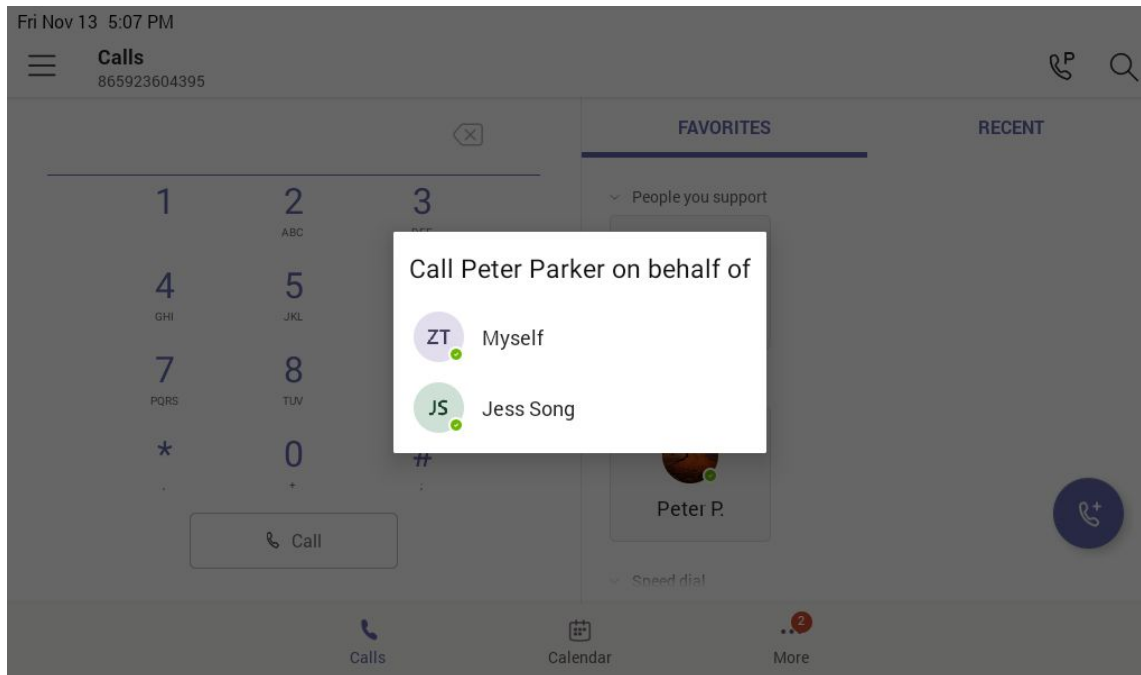

TIP

The image below is for illustration only. The actual user interface may vary from different devices.



Boss' s Call Status

Delegates can see and monitor the boss' call status on the delegate' s phone.

In the example below, the icon  (for VP59/MP58/MP56/MP54/MP52)/  (for CP965) on the Boss' title shows the delegate that the boss is in an active call. You can tap the icon to view additional details about the call.

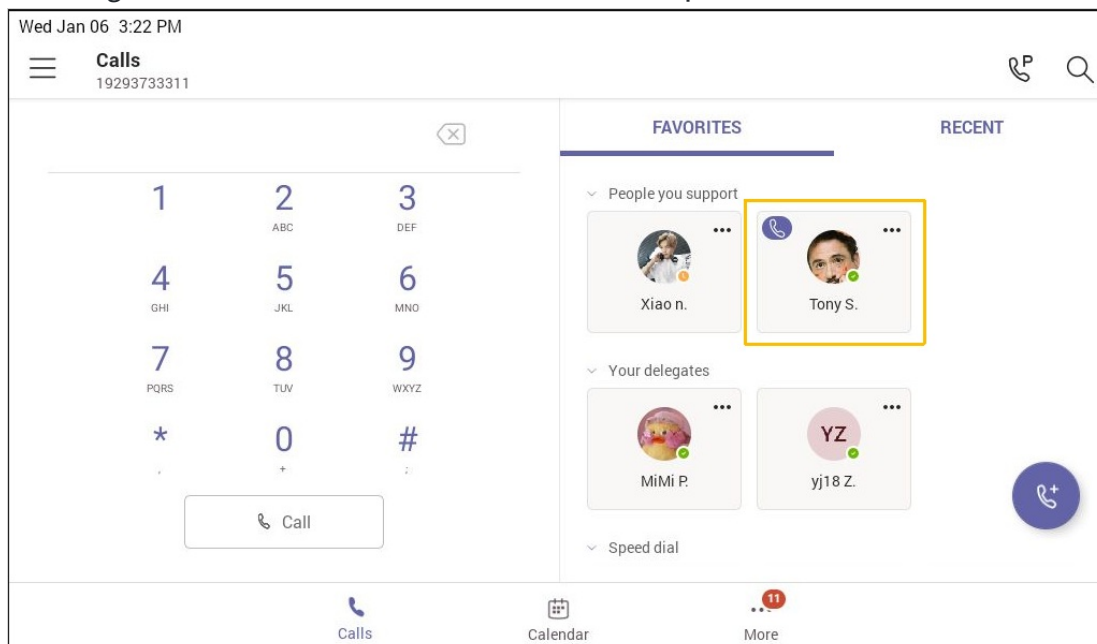

Boss' Held Calls

When the boss puts a call on hold, call status is reflected on the delegate's phone, and the delegate can pick up the call on behalf of the boss.

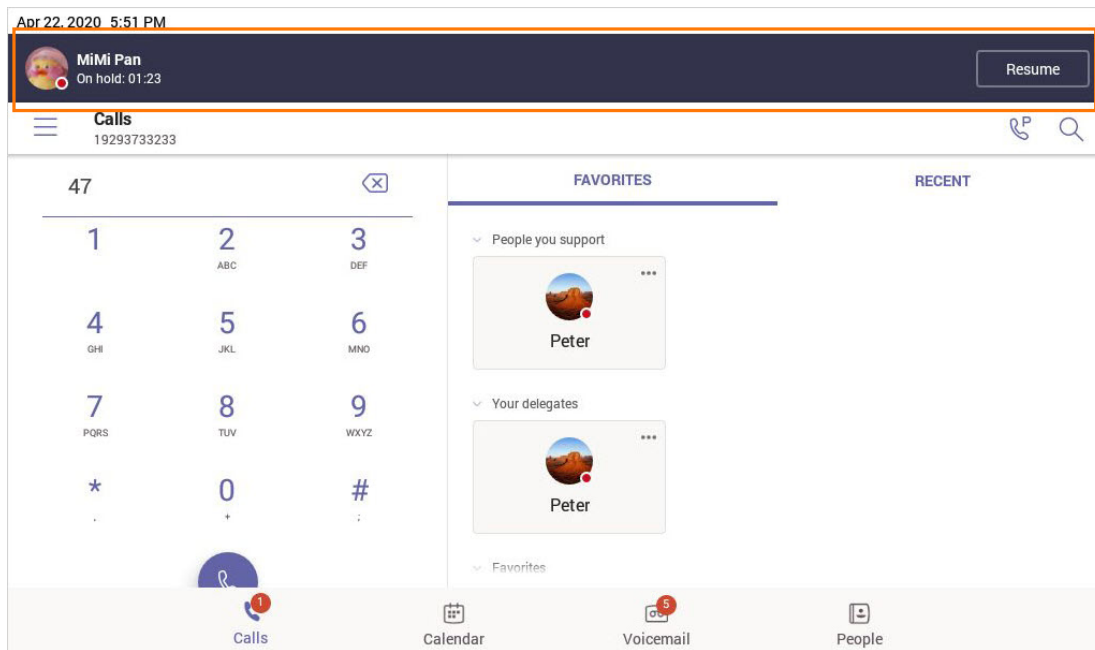

Handle Unanswered Calls

You can handle unanswered calls to voicemail, your contacts, external phone number, or a call group.

NOTE

If you enable the [Call forwarding](#) feature, the **If unanswered** feature will be unavailable.

Procedure

1. Select the method according to your device:

VP59/MP58/MP56/MP54/CP965	MP52
Tap the account avatar and go to Settings > Calling > If unanswered.	Go to  > Settings > Calling > If unanswered.

2. Select **My delegates.**

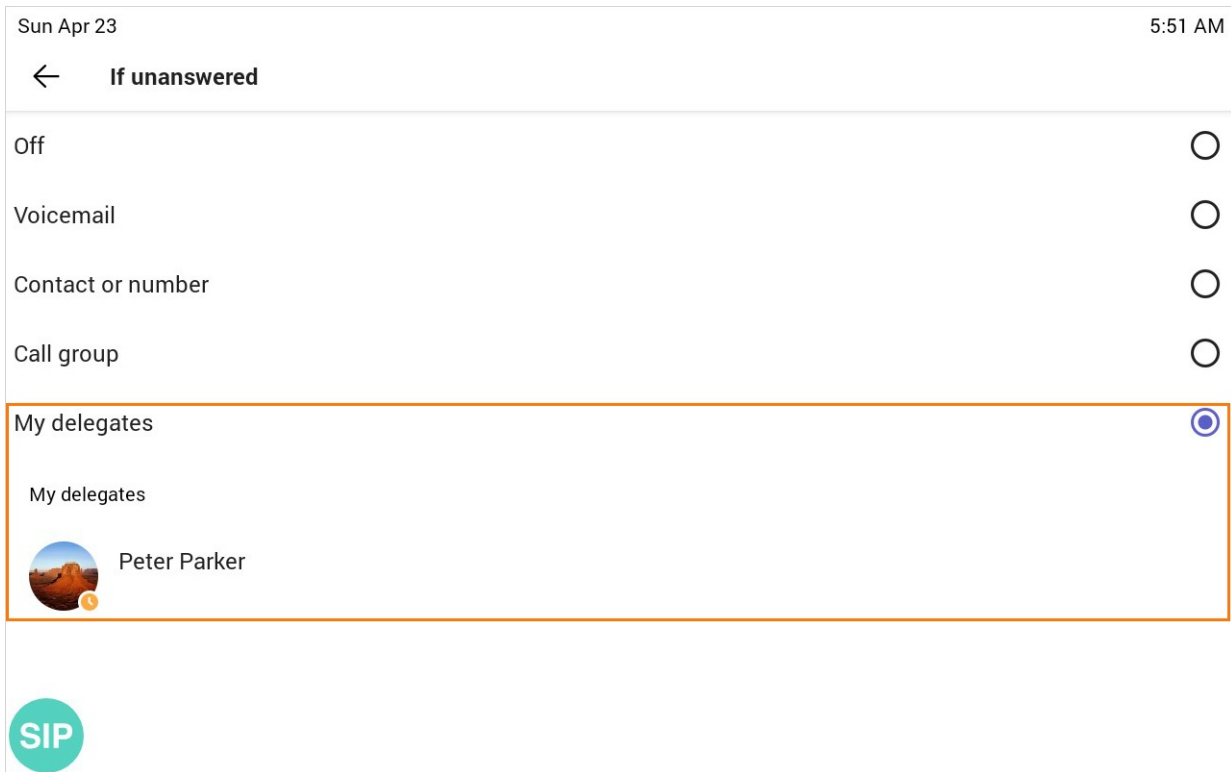

Perform Teams Meeting Operations

Instant Meetings

Users can start an instant meeting on Teams phones. Once the meeting is created, users can add participants by inviting them.

Procedure

1. From the **Calendar** screen, tap .
2. Tap **Join now** to start a meeting.

Initiate a Conference Call

Introduction

You can initiate a conference call by calling contacts, inviting other contacts to the existing call, calling contacts from the call history.

For VP59/MP58/MP56/MP54/CP965

By Calling Multiple Contacts

Procedure





1. Tap  from the Calls screen.
2. Select the desired contacts or search for contacts.

You can add multiple contacts.

3. Tap .

By Inviting Other Contacts

Procedure

1. During the call, tap  ( for CP965).
2. Tap  ( for CP965) on the touch screen.
3. Enter the participant account information to search and then add members.
4. Tap  to initiate a conference.







From Call History

Procedure

1. Tap **Calls** > **RECENT** from the touch screen.
2. Select a desired entry from the call history.
3. Tap .

For MP52

Procedure

1. Do one of the following to place a call:
 - From the Calls screen, select  beside the contact or  key.
 - From the VOICEMAIL screen, select the voice mail record that you want to call, and select .
 - From the PEOPLE screen, select the desired contact, and select  key.
2. Select  and then select .
3. Enter the participant account information to search and then add members.

4. After the party answers the call, select **Done** to initiate a conference.

Schedule a Meeting and Manage It



NOTE

This feature is unavailable to MP52.

Schedule a Meeting

You can schedule meetings on the Teams phone.

Procedure

1. Tap  ( for CP965) from the **Calendar** screen.
2. Enter the title, add the participants, and select start time and end time.
 - You can enable the **All day** feature to set up whole-day meetings.
 - You can enable the **Share to channel** feature to schedule a channel meeting.
3. Enter the location and select the repetition period.
4. To show others your status during this time, tap the **Show as** field and then select **Busy**, **Free**, **Tentative**, or **Out of office**.
5. (Optional) Enter the description of the meeting.
6. Tap  to set up the meeting.

View the Scheduled Meeting Details

You can view details of scheduled meetings, such as the dial-in conference number and meeting ID.

Procedure

1. Tap the desired meeting from the **Calendar** screen.
2. Tap **See more** on the right of the screen.

Edit a Scheduled Meeting

You can edit the scheduled meetings if you are the organizer, such as adding participants.

Procedure

1. Tap the desired meeting from the **Calendar** screen.

2. Tap **Edit**.

For CP965, tap  > **Cancel event**.

3. Edit the meeting.

4. Tap .

Cancel a Scheduled Meeting

If you are the organizer, you can cancel the scheduled meetings.

Procedure

1. Tap the desired meeting from the **Calendar** screen.
2. Tap **Cancel occurrence** at the bottom.

For CP965, tap  > **Cancel event**.

It prompts if you want to cancel this event.



3. Tap **OK**.

For CP965, tap **Cancel event**.

Delete a Scheduled Meeting

If you are a participant, you can delete the meeting that is not started and remove it from your calendar. It will not affect other participants.

Procedure

1. Tap the desired meeting from the **Calendar** screen.
2. Tap  ( for CP965) / **Delete** at the bottom.

It prompts if you are sure to delete the meeting.

3. Tap **OK**.

Handle a Meeting Invitation

NOTE

This feature is unavailable to MP52.

Participants can respond to the meeting scheduled on the Teams phone, the Teams client, or Outlook.

Procedure

1. From the **Calendar** screen, tap the desired meeting.
2. Tap **RSVP**.
3. Select the desired response:
 - Accept (Accept the invitation)
 - Tentative (Tentatively accept the invitation)
 - Decline (Decline the invitation)

Your response is shown below (the image below is only for reference). You can tap the selected response to edit the response to the scheduled meeting.

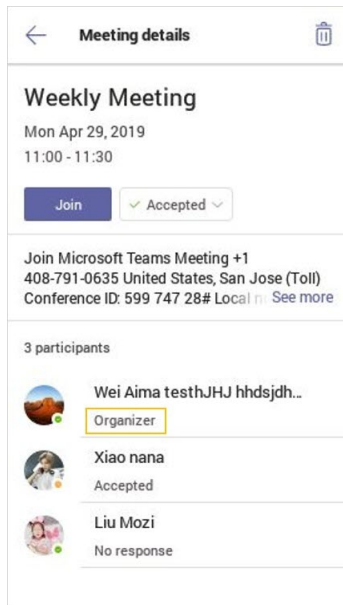

Join a Scheduled Meeting

i NOTE

This feature is unavailable to MP52.

You can join a Teams meeting scheduled on the Teams phone, the Teams client, or Outlook.

Procedure

1. From the Calendar screen, tap **Join** beside the desired meeting.

Invite Participants

Everyone in the conference call can add others to the conference.

Procedure

1. During a conference call, select .

1. During a conference call, select .
2. Select **Add people** on the screen.

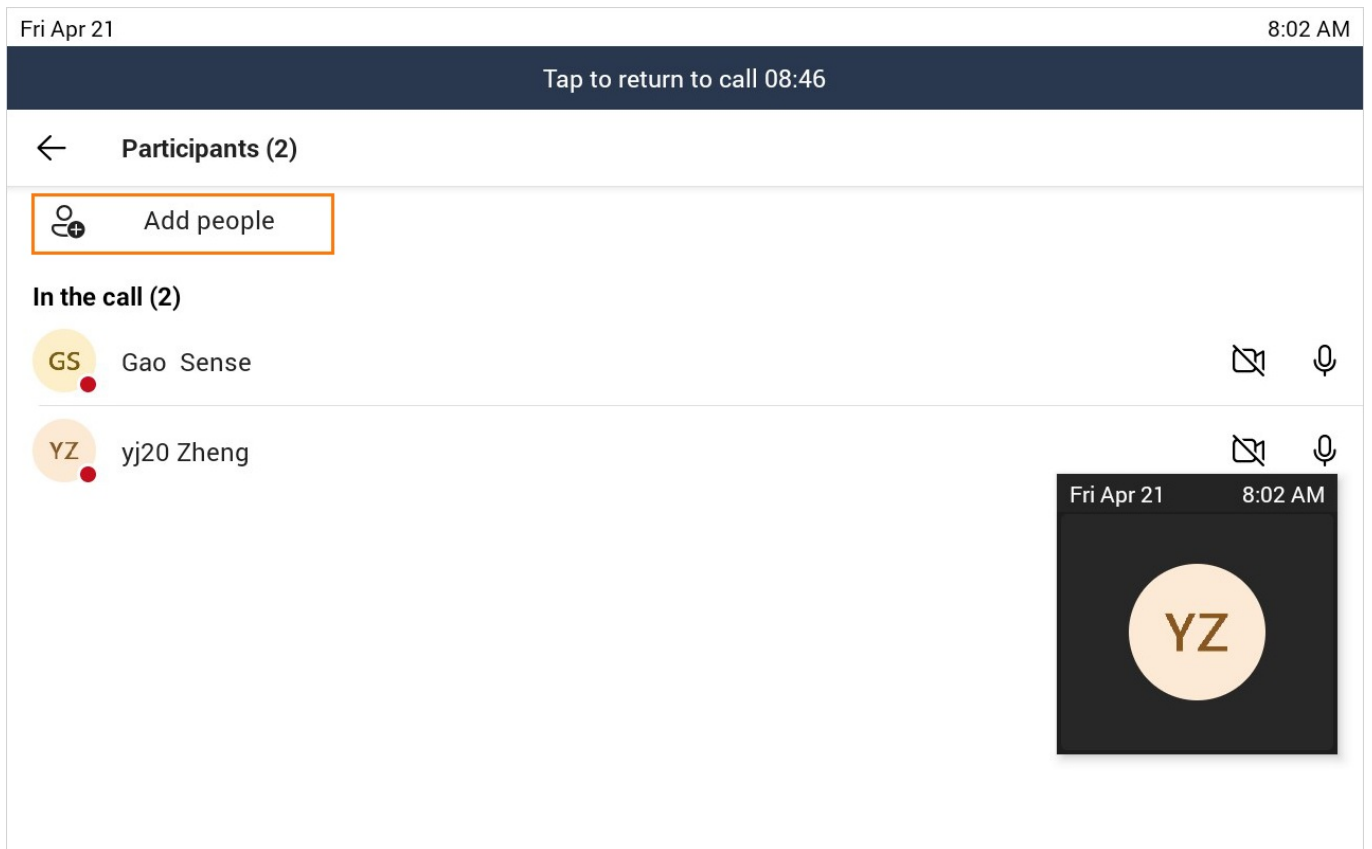

3. Enter the participant account information to search and then add members.

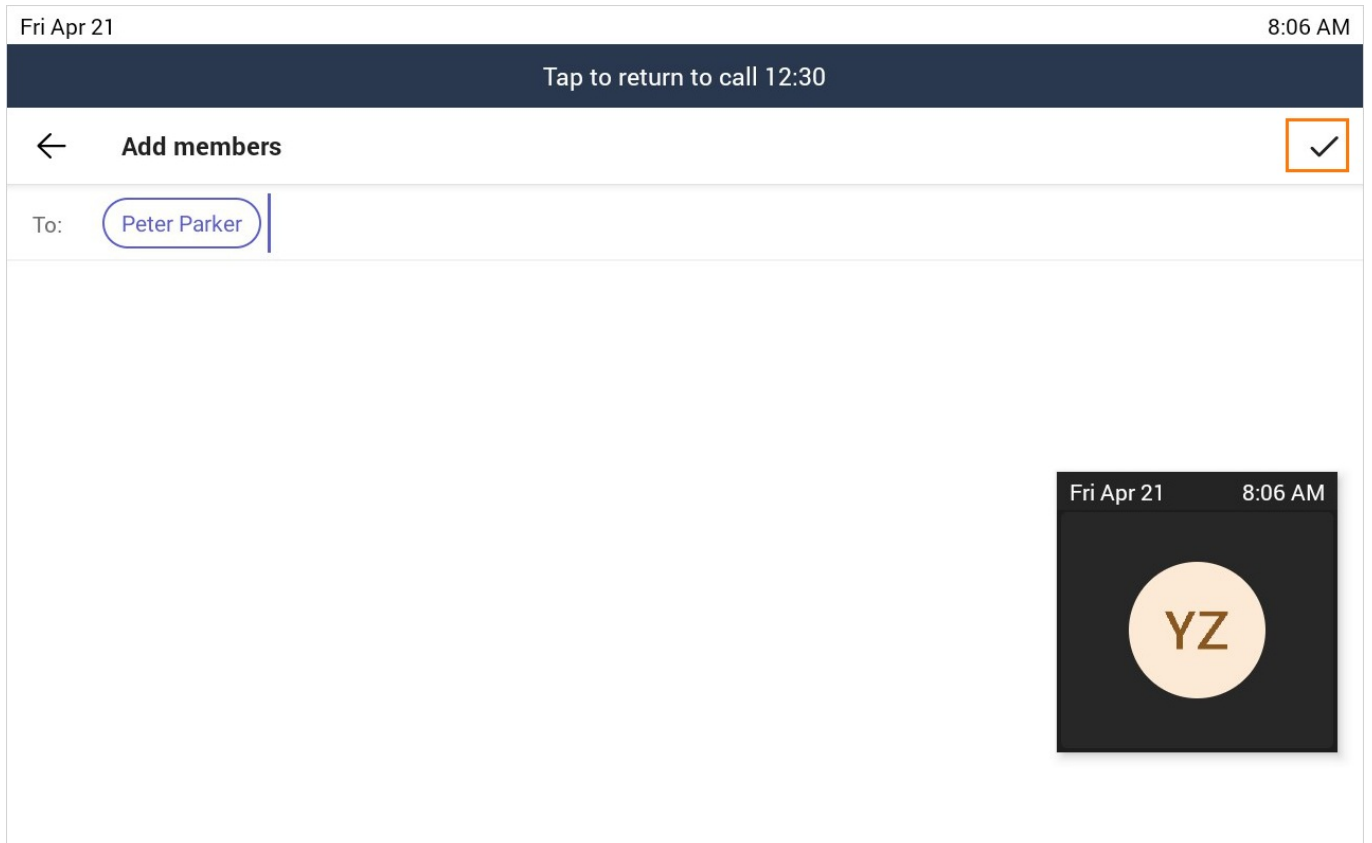

Manage Participants

Everyone in the conference call can manage call participants.

Add Participants to a Conference Call

See [Invite Participants](#).

Mute All Conference Participants

Everyone can mute all other conference participants in the conference call. The participants being muted can only unmute themselves.

Procedure

1. During a conference call, select .
All participants are displayed in the participants list.
2. Select **Mute all**.
All other participants in the conference call are muted.

Mute Individual Conference Participants

Everyone can mute any other conference participants in the conference call.

Procedure

1. During a conference call, select .
All participants are displayed in the participants list.
2. Select the desired participant and then select **Mute participant**.
The participant is muted.

Remove Participants from the Conference

Everyone can remove other conference participants from the conference.

Procedure

1. During a conference call, select .
All participants are displayed in the participants list.

2. Select the desired participant and then select **Remove from the call**.

The participant is displayed in the **Other participants** list, and he/she receives a prompt that indicates he/she was removed from the conference.

Re-invite Participants Who Has Been Removed

You can re-invite the participants who have been removed from the conference call from the **Other participants** list.

Procedure

1. During a conference call, select .

All participants are displayed in the participants list.

2. Select the desired participant from the **Other participants** list and then select **Invite in the call** (VP59/MP58/MP56/MP54/MP52/CP960)/**Ask to join** (CP965).

After the desired participant answers the call, the re-inviting is successful.

View the Details of Participants

You can view the details of participants in the conference call or in the lobby (Other participants list).

1. During a conference call, select .

All participants are displayed in the participants list.

2. Tap the desired participant and then select **View profile**.

Record a Meeting

You can record Teams meetings or calls to capture audio and video.

NOTE

Whiteboards cannot be captured in meeting recordings.

Start Recording

Procedure

1. Go to  > **Start recording**.

For CP965, the recording icon  displays at the top of the call screen.

Stop Recording

Procedure

1. Go to  > **Stop recording**.

For CP965, you can choose to stop recording a call before the call ends. The recording also stops when the active call ends, no matter who ended the call.

Raise Hands

Everyone in the conference can raise hands to apply for speaking.

Procedure

1. During a conference call, select  > **Raise hand**.

Other participants will view the prompt “one person raised hand” on the phone.

Use Live Captions

You can view live captions of all participants said.

Procedure

1. During the conference call, select  > **Turn on live captions**.

Live captions are displayed on the phone screen.

Leave a Meeting

All participants can leave a meeting at any moment.

Procedure

1. Select .

Other participants remain connected.

Proximity Join (CP965 Only)

You can move a Teams meeting on your mobile phone or laptop to the nearby phone by the option of **Add a room**.

NOTE

- This feature is only available to CP965/CP960.
- Make sure you use a meeting account or CAP account.

Procedure

1. Before starting a conference, do one of the following:

- On the mobile phone: Go to **Join now > Join and add a room** and select the desired device.

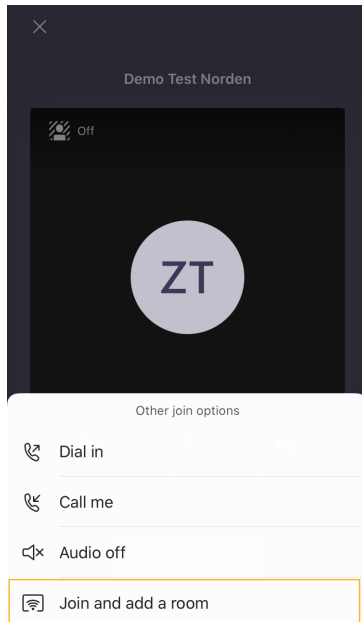

- On the laptop: Select **Room audio (suggested) > Join now**.

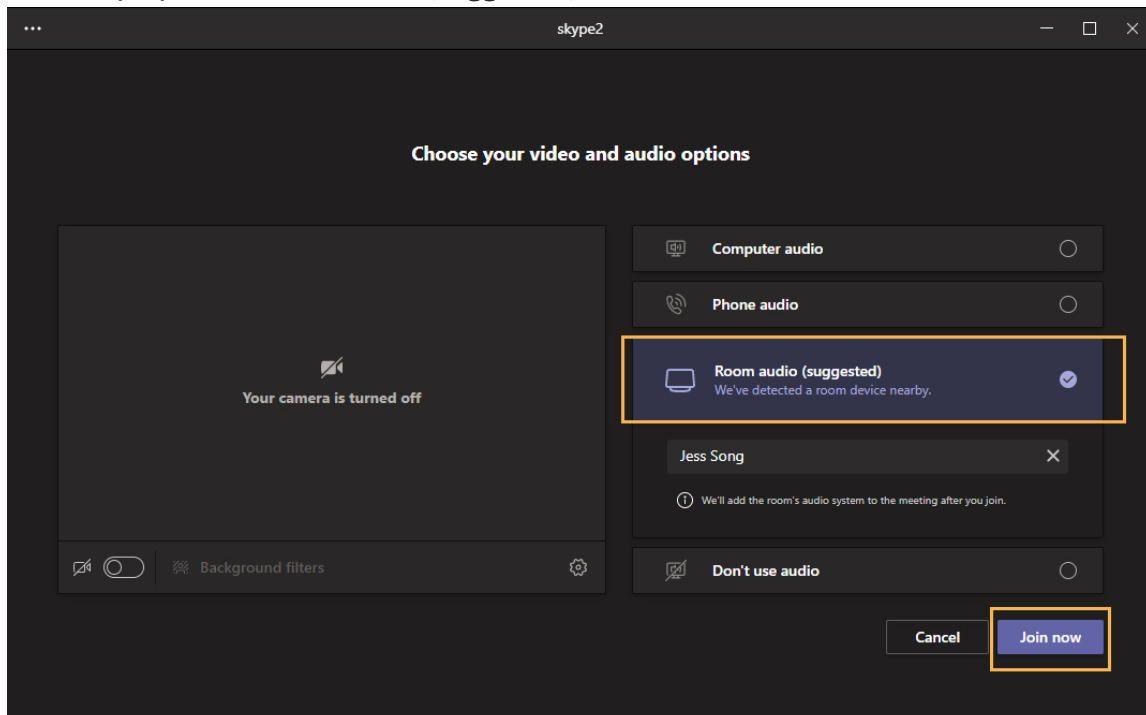

Start Video with Blur (VP59 Only)

You can enable the background blur feature to avoid distractions and unexpected disruptions during video meetings and calls.

NOTE

This feature is only available to VP59.

Procedure

1. During a conference call, select  > **Start video with blur**.

Set Screen Layout (VP59 Only)

You can set the layouts as Gallery, Large Gallery, or Together mode.

NOTE

This feature is only available to VP59.

Procedure

1. Tap  when the meeting is more than four people.
2. Select **Gallery**, **Large gallery**, or **Together mode** to change layouts.

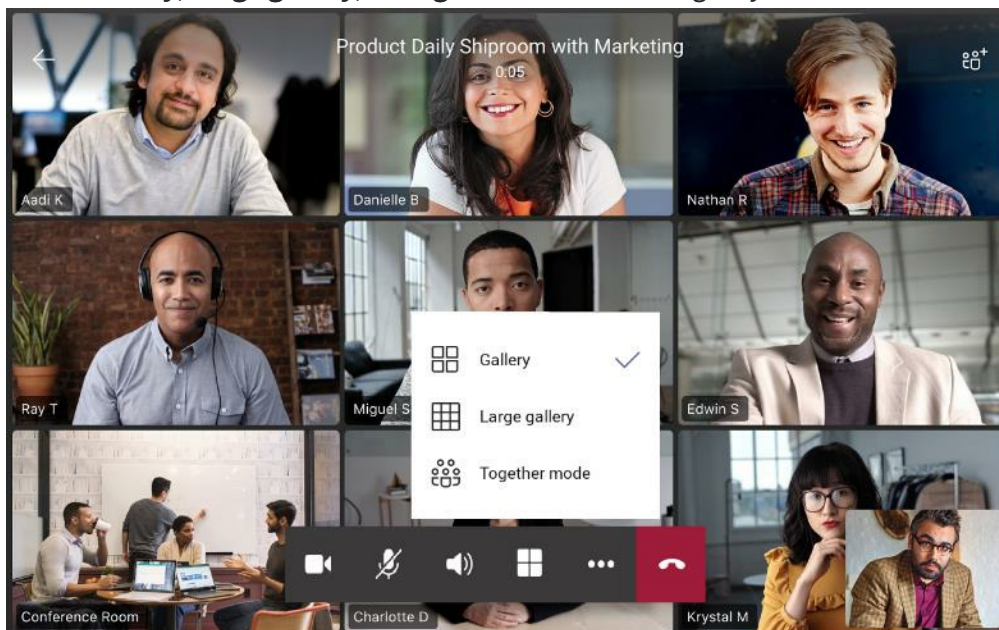

Hold or Resume a Meeting

When you are in a meeting, you can put yourself on hold and resume the meeting when you are ready.

NOTE

This feature is unavailable to CP965.

Put Yourself on Hold

Procedure

1. During a conference call, select  > **Put me on hold**.

For VP59/MP58/MP56, you can also press the  key.

Resume a meeting

Procedure

1. During a conference call, select **Resume**.

For VP59/MP58/MP56, you can also press the  key.

Use Cloud Voicemails

Introduction

Generally, Cloud Voicemail is automatically set up and provisioned.









After you sign into the phone in Personal account mode, all voicemails received on your account will be displayed on your phone.

You can view each voicemail's duration and receiving time stored in your voicemail. After reading the voicemail, you can delete it.

Listen to the Cloud Voicemail

Procedure

1. Select the method according to your device:

CP960/CP965	VP59/MP5X
<ol style="list-style-type: none"> 1. Tap the desired voicemail from the Voicemail screen. 2. Tap  ( for CP965) to play the voicemail. 3. To change the playback speed of the voicemail, tap  . You can also change the speed to 2× or .5× . 4. To pause the playback, tap  ( for CP965). 5. To resume the playback, tap  ( for CP965). 	<ol style="list-style-type: none"> 1. From the VOICEMAIL screen, select the desired voicemail. The voicemail will play automatically. 2. Select  or THE  key to stop playing.

Delete Cloud Voicemails

After you listen to a message, you can delete it.

1. From the **Voicemail** screen, select the desired voicemail.
2. Select  below the voicemail.



It prompts if you are sure to delete the voicemail.
3. Select **DELETE** (**Delete** for MP52).

View Cloud Voicemails' Senders

You can view the details of the person who left you a message.

i NOTE

This feature is unavailable to CP965.

1. From the **Voicemail** screen, tap the desired voicemail.
2. Tap  ( for CP965) below the voicemail.

FAQ

How to change the greeting language for the voicemail?

Please see the Microsoft doc on [Manage Cloud Voicemail settings for users](#) .

Contacts and Favorites



Manage Contacts

NOTE

This feature is unavailable to MP52.

Add Contacts from the Directory

Procedure

1. From the **People** screen, tap .
2. Tap  ( for CP965).
3. Enter the search criteria.
4. Tap the desired contact and select a group.
5. Save the change.

The contact appears in the selected group.

Add Contacts to a Specific Group

Procedure

1. From the **People** screen, select **All Contacts** or a specific group.
2. Tap the desired contact.
3. Click the three dots and select **Add to group**.
4. Select the desired group.

The contact is added to the selected group.

Remove Contacts from the Group

Procedure

1. From the **People** screen, select a specific group.
2. Tap the desired contact.
3. Click the three dots and select **Remove from group**.
4. Select the desired group.

You remove the contact from the selected group successfully.

Manage Contact Groups

View All Contact Groups

Procedure

1. From the **People** screen, select **All Contacts** .

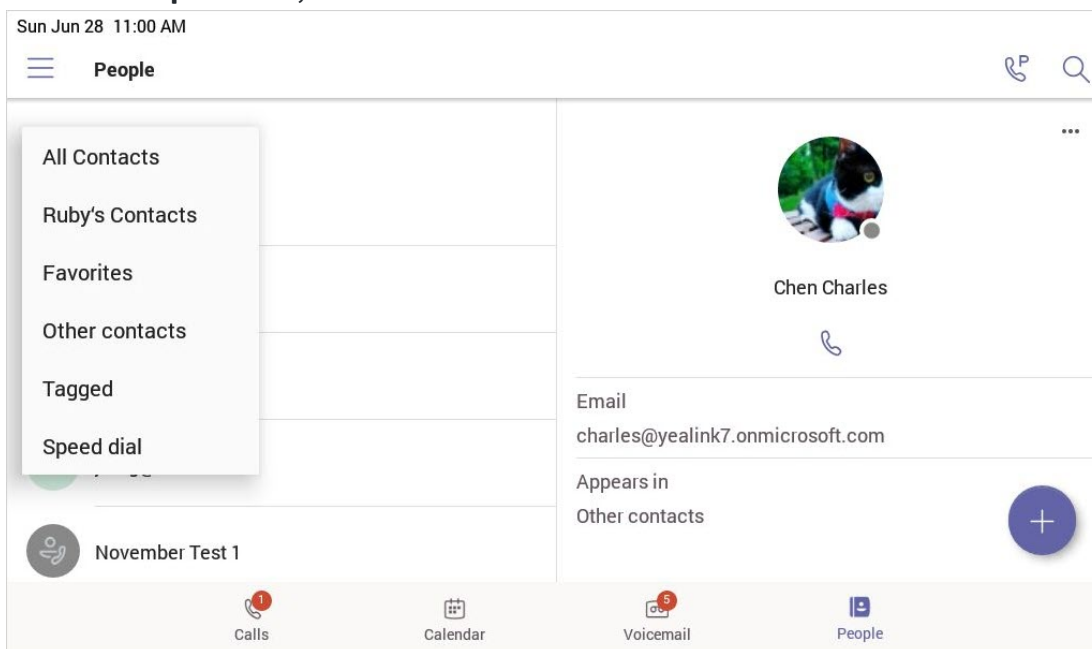

You can tap the desired contact group to view the contacts in the group.

Create New Groups

NOTE

This feature is unavailable to MP52.

Procedure

1. From the **People** screen, tap .

2. Tap **Create new group**.
3. Name your group.
4. Select **CREATE**.

Edit Contact Group Name

NOTE

This feature is unavailable to MP52.

Procedure

1. From the **People** screen, select  > **Edit group**
2. Select a group to edit and rename your group.
3. Save the change.

Delete Contact Groups

NOTE

This feature is unavailable to MP52.

Procedure

1. From the **Edit group** screen, tap **Delete group**.

You delete the contact group successfully.

Manage Favorites

By default, all favorite contacts from the Teams desktop client are marked as favorite contacts on the phone. You can add favorites or remove favorites.

NOTE

This feature is unavailable to MP52.

Add Favorites

Procedure

1. From the **Calls** screen, tap **RECENT**.

2. Tap the desired contact.
3. Select the method according to your device:

VP59/MP58/MP56/MP54	CP965
Tap  .	Go to  >  > Add to contacts > Favorites.

The contact appears in the **FAVORITES** list.

Remove Favorites

Procedure

1. From the **Calls** screen, tap **FAVORITES**.
2. Tap the three dots on the desired contact.
3. Tap **Remove speed dial**.

Teams Device Settings

Using the Dark Theme

By default, the light theme is enabled. You are allowed to change between light and dark theme.

NOTE

- The dark theme will change to the light theme if the account signs out.
- This feature is unavailable to MP52.

Procedure

1. Tap the account avatar and go to **Settings > Appearance > Dark**.

It prompts that it will restart the app to switch the theme.

2. Confirm the option.

After you restart the phone, the screen is displayed as follows (take VP59 as an example):

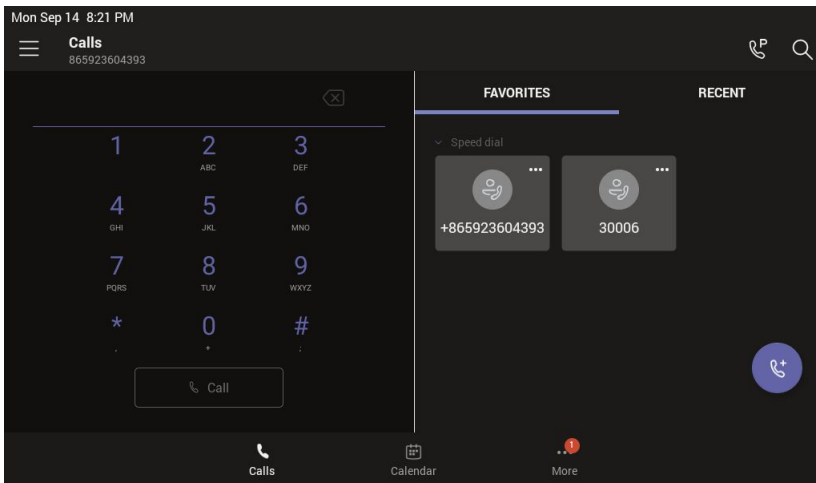

Setting the Language

The default language of the phone depends on what you set after the phone starts up. You can change the language.

Procedure

1. Select the method according to your device:

VP59/MP58/MP56/MP54/CP965	MP52
Tap the account avatar and go to Settings > Device settings > Language .	Go to  > Settings > Device settings > Language .

2. Select the desired language.

It prompts if you are sure to change the language.

3. Save the change.

If your phone is set as a common area phone, select the method according to your device:

VP59/MP58/MP56/MP54/CP965	MP52
Tap the account avatar and go to Settings > Device Settings > Language (default password: admin) to set the language.	Go to  > Settings > Device Settings > Language (Admin only, default password: admin) to set the language.

Time and Date Display

You can set the time and date manually. The time and date format is also customizable.

Set the Time and Date Manually

If your phone cannot automatically obtain the time and date, you can set the time and date manually.

Procedure

1. Select the method according to your device:

VP59/MP58/MP56/MP54/CP965	MP52
Tap the account avatar and go to Settings > Device settings > Time & Date .	Go to  > Settings > Device settings > Time & Date .

If your phone is set as a common area phone, select the method according to your device:

VP59/MP58/MP56/MP54/CP965	MP52
Tap the account avatar and go to Settings > Device Settings > Time & Date (default password: admin).	Go to  > Settings > Device Settings > Time & Date (Admin only, default password: admin).

2. Select **Manual Settings** from the **Type** field and tap **OK** (for MP52, select the  key).
3. Enter the specific date and time in the **Date** and **Time** field respectively.

Change the Time and Date Format

You can change the time and date format.

About this task:

The built-in date formats are listed below:

Date Format	Example(2018-05-30)
WWW MMM DD	Wed May 30
DD-MMM-YY	30-May-18
YYYY-MM-DD	2018-05-30
DD/MM/YYYY	30/05/2018
MM/DD/YY	05/30/18
DD MMM YYYY	30 May 2018
WWW DD MMM	Wed 30 May

MM/DD/YYYY

05/30/2018

Procedure

1. Select the method according to your device:

VP59/MP58/MP56/MP54/CP965	MP52
Tap the account avatar and go to Settings > Device settings > Time & Date .	Go to  > Settings > Device settings > Time & Date .

2. Select the desired date format from the **Date Format** field.
3. Select the desired time format from the **Time Format** field.

If your phone is set as a common area phone, select the method according to your device:

VP59/MP58/MP56/MP54/CP965	MP52
Tap the account avatar and go to Settings > Device Settings > Time & Date (default password: admin).	Go to  > Settings > Device Settings > Time & Date (Admin only, default password: admin).

Screen Savers

The screen saver automatically starts each time your device is idle for a certain amount of time. You can stop the screen saver at any time by pressing any key or tapping the touch screen. The screen saver starts again when your device is idle again for a preset waiting time.

Change the Waiting Time for Screen Saver

You can change the waiting time for the screen saver.

Procedure

1. Select the method according to your device:

VP59/MP58/MP56/MP54/CP965	MP52
Tap the account avatar and go to Settings > Device Settings > Display .	Go to  > Settings > Device Settings > Display .

2. Select the desired time from the **Screensaver Waiting Time** field.

3. Save the change.

If your phone is set as a common area phone, select the method according to your device:

VP59/MP58/MP56/MP54/CP965	MP52
Tap the account avatar and go to Settings > Device Settings > Display (default password: admin) > Screensaver Waiting Time to change the waiting time for the screen saver.	Go to  > Settings > Device Settings > **Display ** (admin only, default password: admin) > Screensaver Waiting Time to change the waiting time for the screen saver.

Change the Screen Saver Background

You can change the screen saver background of the device. You can also set the device to display the custom background.

Procedure

1. Select the method according to your device:

VP59/MP58/MP56/MP54/CP965	MP52
Tap the account avatar and go to Settings > Device Settings > Display .	Go to  > Settings > Device Settings > Display .

2. Select the desired background from the **Screensaver background** field.

3. Select the desired type from the **Screen Saver Type** field.

- If you select **System**, select the desired background from the **Screensaver background** field.
- If you select **Custom**, the device automatically set the custom pictures uploaded from the web user interface as the screen saver and display these pictures alternately.

4. Save the change.

If your phone is set as a common area phone, select the method according to your device:

VP59/MP58/MP56/MP54/CP965	MP52
Tap the account avatar and go to Settings > Device Settings > Display (admin only, default password: admin) > Screensaver Background to change the screen saver background.	Go to  > Settings > Device Settings > Display (admin only, default password: admin) > Screensaver Background to change the screen saver background.

Disable Screen Saver

By default, the screen saver feature is enabled. You can disable it as needed.

Procedure

1. Select the method according to your device:

VP59/MP58/MP56/MP54/CP965	MP52
Tap the account avatar and go to Settings > Device Settings > Display .	Go to  > Settings > Device Settings > Display .

2. Disable the screen saver.

If your phone is set as a common area phone, select the method according to your device:

VP59/MP58/MP56/MP54/CP965	MP52
Tap the account avatar and go to Settings > Device Settings > Display (admin only, default password: admin) > Screen Saver Enable to disable the screen saver.	Go to  > Settings > Device Settings > Display (admin only, default password: admin) > Screen Saver Enable to disable the screen saver.

Changing the Screen Backlight Brightness and Time

See [Changing the Screen Backlight Brightness and Time](#).

Better Together over Bluetooth (BToB)

After the phone is paired with PC, it supports lock, unlock, screen off, and screen awake operations via BToB.

NOTE

This feature is only available to MP58/MP56/MP54 and VP59.

Pairing the Device with PC

Before you begin

Make sure the Bluetooth is enabled on the phone (**default**: enabled).

Procedure

1. Sign in on Microsoft Teams client installed on laptop or PC.
2. Enable Bluetooth on laptop or PC.
3. Sign in on the phone with the same account on Microsoft Teams client.

4. Tap the account avatar and select **Connect a device**.

The phone shows the available device to connect.

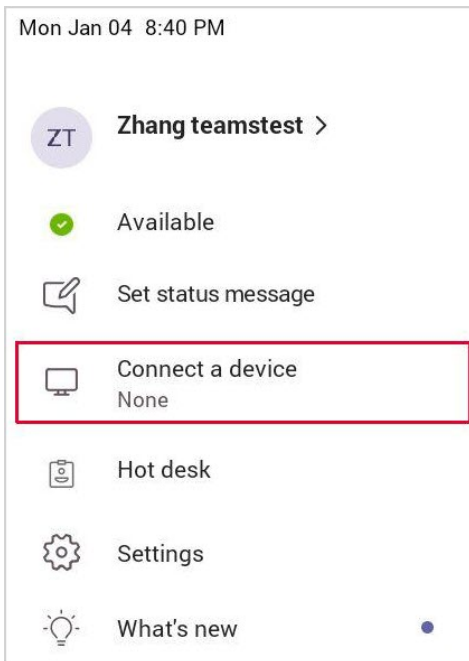

5. Pair the device with laptop or PC.

Laptop or PC will get the notification to accept the connection.

6. On the Microsoft Teams client, click on **Connect** in the notification.

BToB Lock

When the phone is **paired** with the laptop or PC and phone lock is enabled on the phone, Lock/unlock on the phone is in sync with the laptop or PC.

BToB Meeting

Once you join a meeting/call on a laptop or PC, you can use the connected phones or Teams Windows clients to control the meeting/call.

Before you begin

The phone is **paired** with the laptop or PC.

Accessibility Features

The phone includes a number of features to accommodate users who have low vision person who is blind.

Large Text

You can change the displayed text size.

NOTE

This feature is unavailable to MP52.

Procedure

1. Tap the account avatar and go to **Settings > Device settings > Accessibility**.
2. Turn on **Large Text**.

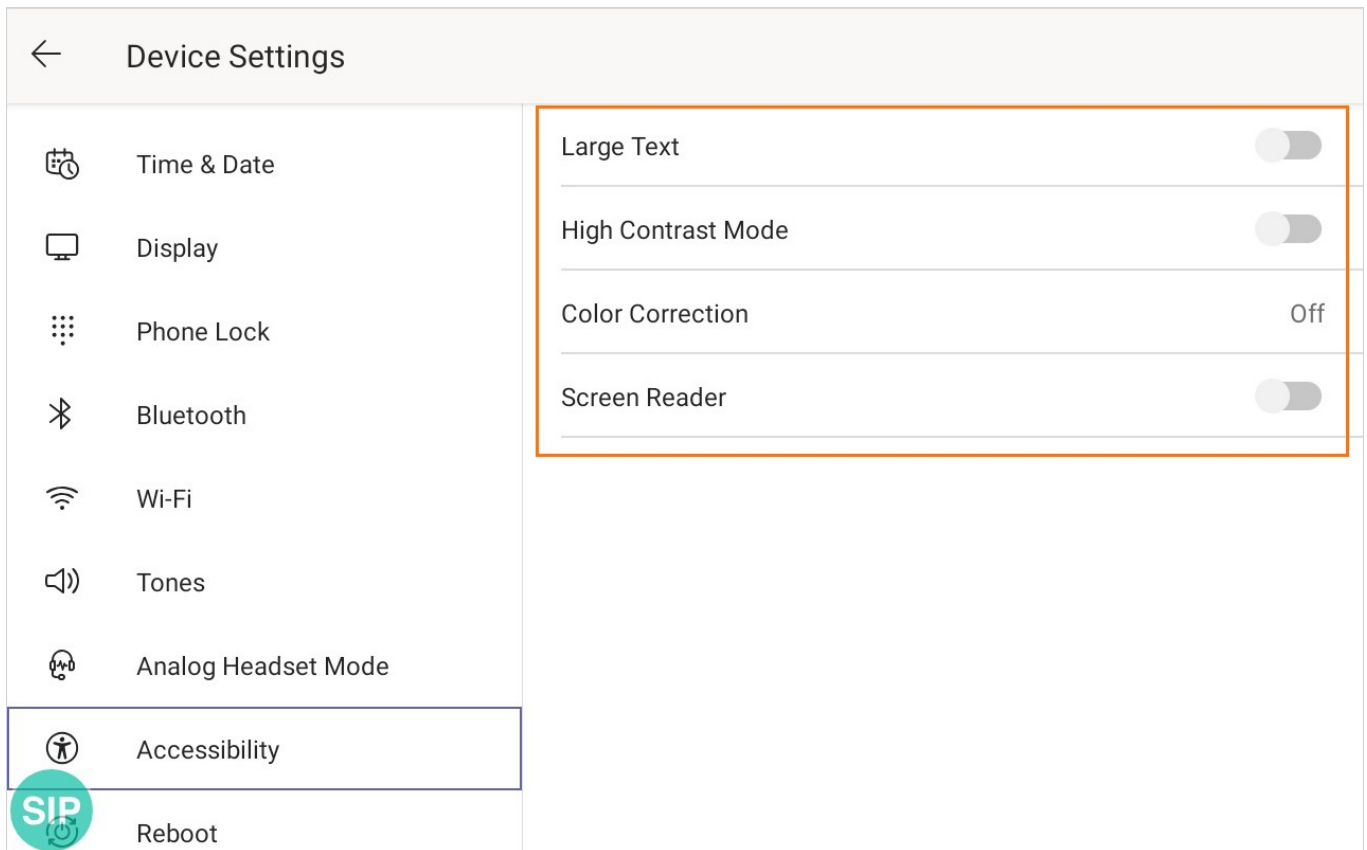
**High Contrast Mode**

You can change the contrast if any difficulties in reading text on the screen.

Procedure

1. Select the method according to your device:

VP59/MP58/MP56/MP54/CP965	MP52
Tap the account avatar and go to Settings > Device Settings > Accessibility .	Go to  > Settings > Device Settings > Accessibility .

2. Turn on **High Contrast Mode**.

Color Correction

You can change color mode if any difficulties in color recognition.

Procedure

1. Select the method according to your device:

VP59/MP58/MP56/MP54/CP965	MP52
Tap the account avatar and go to Settings > Device Settings > Accessibility .	Go to  > Settings > Device Settings > Accessibility .

2. Select the desired value from the **Color Correction** field.
 - Off
 - Deuteranomaly (red-green)
 - Protanomaly (red-green)
 - Tritanomaly (blue-yellow)
3. For VP59/MP58/MP56/MP54/CP965, tap **OK** to save the change.

Screen Reader

The phone can read where you tap.

NOTE

This feature is unavailable to MP52.

Procedure

1. Tap the account avatar and go to **Settings > Device Settings > Accessibility**.
2. Turn on **Screen Reader**.

Setting Ringtones

You can set different ringtones for incoming, forwarded, and delegated calls.

Procedure

1. Select the method according to your device:

VP59/MP58/MP56/MP54/CP965	MP52
Tap the account avatar and go to Settings > Calling .	Go to  > Settings > Calling .

2. Select the desired ringtone from an available list of ringtone options.

Ringtones	
Calls for you	Default
Forwarded calls	Default
Delegated calls	Default

FAQ

How to adjust the ringtone volume?

To adjust the ringtone volume, please directly press the Volume up or Volume down keys when the phone is idle.

Do the MP Teams phones support customizing ringtones?

No, currently customizing ringtone is unavailable.

Phone Lock

When the phone is not used, you can enable the phone lock to prevent unauthorized users from viewing or modifying phone information, such as your scheduled meetings. When the phone is locked, you can still answer the incoming call. If the administrator forcibly enables the phone lock feature on the Microsoft Teams & Skype for Business Admin Center, you cannot disable it on the phone. For more information, contact your system administrator.

Create a Lock PIN

If your administrator sets security restrictions and enables the phone lock for you, you are prompted to set up a lock PIN used for unlocking your phone.

Procedure

1. Select the method according to your device:

VP59/MP58/MP56/MP54/CP965	MP52
<p>1. Tap OK to create a lock PIN on the pop-up menu.</p> <div data-bbox="215 383 644 676" style="border: 1px solid black; padding: 10px; margin: 10px 0;"> <p>Your company requires that you secure this phone with phone lock PIN in order to prevent unauthorized people to access to sensitive information. Let's set it up now.</p> <p style="text-align: right; color: blue;">OK</p> </div> <p>2. Enter the lock PIN in the New PIN field.</p> <p>3. Enter the lock PIN again in the Confirm PIN field.</p> <p>4. Tap OK.</p>	<p>1. Go to  > Settings > Lock Screen & PIN > PIN > Set PIN.</p> <p>2. Enter the lock PIN.</p> <p>3. Enter the lock PIN again.</p>

Enable Phone Lock

NOTE

This feature is unavailable to MP52.

Procedure

1. Tap the account avatar and go to **Settings** > **Device Settings** > **Phone Lock**.
2. Enable **Lock Enable**.
3. Enter the lock PIN in the New PIN field.
4. Enter the lock PIN again in the Confirm PIN field.

You can use your lock PIN to unlock your phone.

5. Save the change.

Set the Idle Timeout for Phone Lock

You can configure the idle timeout, after which the phone will be locked automatically.

TIP

You can long press the # key 3 seconds to lock the phone.

Procedure

1. Select the method according to your device:

VP59/MP58/MP56/MP54/CP965	MP52
<ol style="list-style-type: none"> 1. Tap the account avatar and go to Settings > Device Settings > Phone Lock. 2. Enter the unlock PIN and tap Unlock. 	Go to  > Settings > Lock Screen & PIN > Timeout .

2. Select the desired value.
3. Save the change.

Unlock Your Phone**Procedure**

1. Select the method according to your device:

VP59/MP58/MP56/MP54/CP965	MP52
Tap  for CP965) on the touch screen.	Select the rightmost soft key.

2. Enter the unlock PIN.

NOTE

You will be forced to sign out after five unsuccessful unlock attempts. After five unsuccessful unlock attempts, the system will automatically sign your account out.

Change Your Lock PIN

You can change your lock PIN at any time.

Procedure

1. Select the method according to your device:

VP59/MP58/MP56/MP54/CP965	MP52
<ol style="list-style-type: none"> 1. Tap the account avatar and go to Settings > Device Settings > Phone Lock. 2. Enter the unlock PIN and tap Unlock. 3. Enter the new lock PIN in the New PIN field. 4. Enter the lock PIN again in the Confirm PIN field. 5. Save the change. 	<ol style="list-style-type: none"> 1. Go to  > Settings > Lock Screen & PIN > PIN > Change PIN. 2. Enter the old lock PIN. 3. Enter the new lock PIN. 4. Enter the new lock PIN again.

Disable Phone Lock

If your system administrator sets security restrictions and enables the phone lock, you are restricted from disabling it.

Procedure

1. Select the method according to your device:

VP59/MP58/MP56/MP54/CP965	MP52
<ol style="list-style-type: none"> 1. Tap the account avatar and go to Settings > Device Settings > Phone Lock. 2. Enter the unlock PIN and tap Unlock. 3. Disable Lock Enable. 	<ol style="list-style-type: none"> 1. Go to  > Settings > Lock Screen & PIN > PIN > Clear PIN. 2. Enter the old lock PIN.

Bluetooth

Available Bluetooth Devices

What kind of Bluetooth devices can I connect to my phone devices?

For MP58/MP56/MP54/MP52/VP59	For CP965/CP960
Bluetooth headsets Bluetooth handsets	Bluetooth headsets Bluetooth handsets Bluetooth-enabled mobile phones Bluetooth-enabled PC

TIP

- For CP965/CP960, you can use them as Bluetooth speakers for your mobile phone and PC. To enable the media audip on CP965/CP960, see [Enable the Media Audio \(CP965&CP960 Only\)](#).
- For VP59, You **CANNOT** use the Bluetooth feature and CPW90-BT-Single device at the same time. You can only activate either Bluetooth mode or Mic-BT mode.

Activate/Deactivate the Bluetooth Mode

You need to activate Bluetooth mode to use the Bluetooth feature.

NOTE

For MP54/MP52, make sure the Bluetooth USB Dongle BT41 is connected to the phone.

Procedure

1. Select the method according to your device:

VP59/MP58/MP56/MP54/CP965	MP52
Tap the account avatar and go to Settings > Device settings > Bluetooth.	Go to  > Settings > Device Settings > Bluetooth.

2. Turn on/off **Bluetooth.**

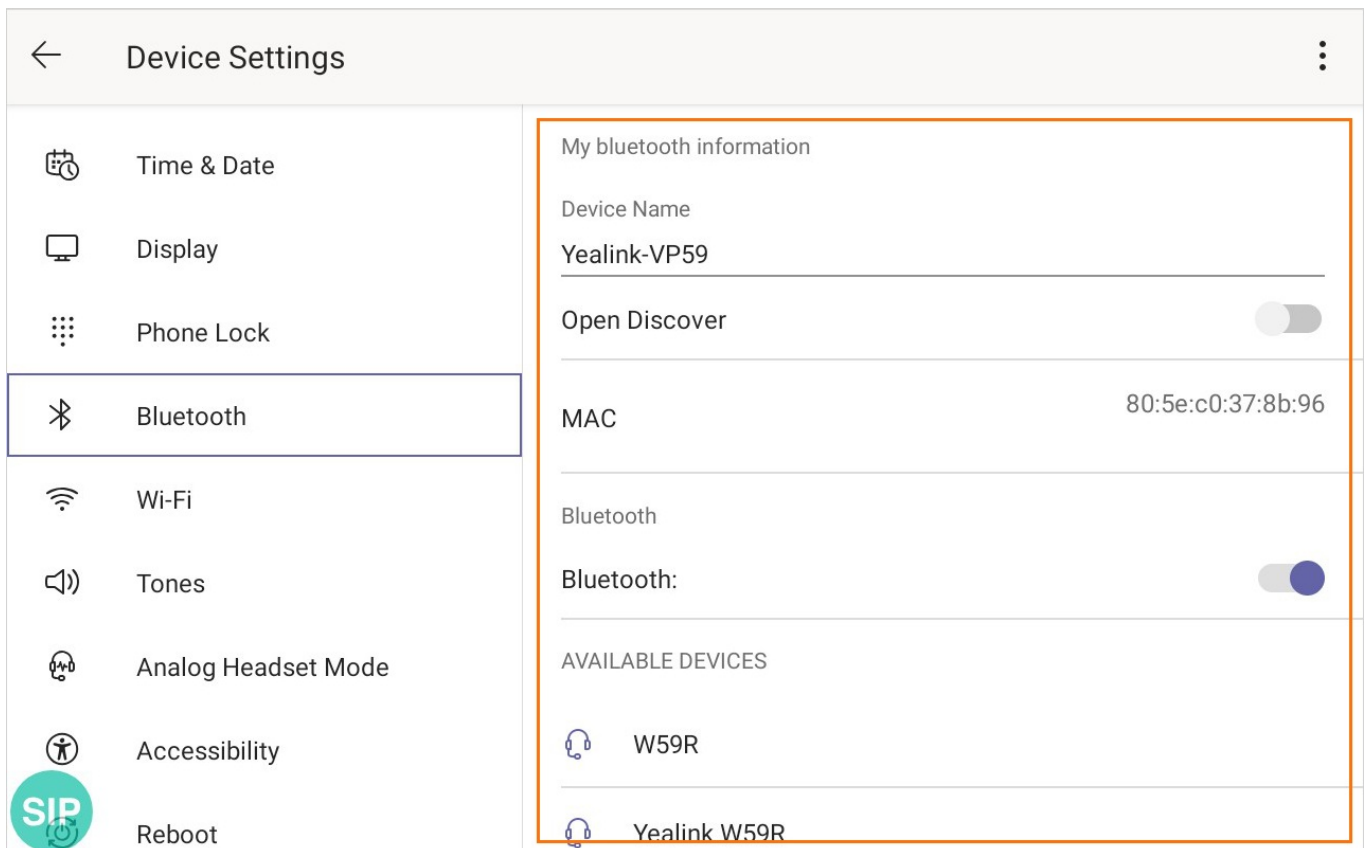



Pair and Connect the Bluetooth Devices

Before you begin

Make sure that you have activated the Bluetooth mode and the Bluetooth device is discoverable.

Procedure

1. Select the method according to your device:

VP59/MP58/MP56/MP54/CP965	MP52
<ol style="list-style-type: none"> 1. Tap the account avatar and go to Settings > Device settings > Bluetooth. 2. Go to  > Scan to search for the Bluetooth devices. 	<ol style="list-style-type: none"> 1. Go to  > Settings > Device Settings > Bluetooth. 2. Select Scan to search for the Bluetooth devices.

2. Tap your Bluetooth device in the **AVAILABLE DEVICES** list.

The Bluetooth device is paired and connected successfully.

Edit Your Device Name

You can change the Bluetooth device name for your phone.

Before you begin

Make sure that you have activated the Bluetooth mode.

Procedure

1. Select the method according to your device:

VP59/MP58/MP56/MP54/CP965	MP52
<ol style="list-style-type: none"> 1. Tap the account avatar and go to Settings > Device settings > Bluetooth. 2. Enter the desired name in the Device Name field. 	<ol style="list-style-type: none"> 1. Go to  > Settings > Device Settings > Bluetooth. 2. Select My bluetooth information and enter the desired name in the Device Name field.

Enable/Disable Your Device Discovery

After the Bluetooth is turned on, your phone is visible to other Bluetooth-enabled devices by default. You can disable this feature to make your phone undiscoverable for other Bluetooth devices.

Procedure

1. Select the method according to your device:

VP59/MP58/MP56/MP54/CP965	MP52
---------------------------	------

1. Tap the account avatar and go to **Settings > Device settings > Bluetooth**.
2. Enter the desired name in the **Device Name** field.

1. Go to  > **Settings > Device Settings > Bluetooth**.
2. Select **My bluetooth information**.

2. Turn on/off **Open Discover**.

Rename the Paired Bluetooth Devices

You can rename the paired Bluetooth devices for better recognition.

Procedure

1. Select the method according to your device:

VP59/MP58/MP56/MP54/CP965	MP52
<ol style="list-style-type: none"> 1. Tap the account avatar and go to Settings > Device settings > Bluetooth. 2. Long tap the connected mobile phone/PC and select Details. 3. Enter the desired name in the Rename field. 4. Tap OK. 	<ol style="list-style-type: none"> 1. Go to  > Settings > Device Settings > Bluetooth. 2. Select the paired device and then select More. 3. Select Details and enter the desired name in the Device field. 4. Select Done.

Disconnect the Bluetooth Device

You can disconnect the Bluetooth device from your phone. After the Bluetooth device is disconnected, it stays in the paired devices list so that you can easily connect it to your phone next time.

Procedure

1. Select the method according to your device:

VP59/MP58/MP56/MP54/CP965	MP52
<ol style="list-style-type: none"> 1. Tap the account avatar and go to Settings > Device settings > Bluetooth. 2. Select the connected Bluetooth device. It prompts if you are sure to disconnect. 3. Tap OK. 	<ol style="list-style-type: none"> 1. Go to  > Settings > Device Settings > Bluetooth. 2. Select the paired device and then select More. 3. Select Disconnect. It prompts if you are sure to disconnect. 4. Select OK.

Un-pair the Bluetooth Devices

You can unpair your Bluetooth devices with your Teams phone. After unpaired, the Bluetooth devices disappear from the paired devices list.

Procedure

1. Select the method according to your device:

VP59/MP58/MP56/MP54/CP965	MP52
<ol style="list-style-type: none"> 1. Tap the account avatar and go to Settings > Device settings > Bluetooth. 2. Long tap the paired device and then select Unpaired. It prompts if you are sure to unpair. 3. Tap OK. 	<ol style="list-style-type: none"> 1. Go to  > Settings > Device Settings > Bluetooth. 2. Select the paired device and then select More. 3. Select Unpair. It prompts if you are sure to disconnect. 4. Select OK.

Enable the Media Audio (CP965&CP960 Only)

You can enable the media audio feature to use the phone as a Bluetooth speaker for your mobile phone or PC.

Procedure

1. Tap the account avatar and go to **Settings > Device settings > Bluetooth**.
2. Long tap the connected mobile phone/PC and select **Details**.
3. Enable **Media audio**.
4. Tap **OK**.

Enable/Disable the Phone Audio (CP965&CP960 Only)

By default, the phone audio is enabled, so the phone can act as a speaker and microphone for your connected mobile phone.

The call is made through your mobile phone, but the audio is present on the phone. You can disable it.

Procedure

1. Tap the account avatar and go to **Settings > Device settings > Bluetooth**.
2. Long tap the connected mobile phone/PC and select **Details**.
3. Enable **Phone audio**.
4. Tap **OK**.

Wireless Network

Wireless Network

The Teams phone supports the Wi-Fi feature. If there is available Wi-Fi, you can enable the Wi-Fi feature to connect the device to the wireless network.

TIP

The phones can automatically connect to the wireless network via a Yealink-supplied App. For more information, refer to [Easy Way to Connect to a Wireless Network via App](#).

Activate/Deactivate the Wi-Fi Mode

Before you begin

For MP54/MP52, make sure the the Wi-Fi USB Dongle WF50 is connected to the phone.

Procedure

1. Select the method according to your device:

VP59/MP58/MP56/MP54/CP965	MP52
Tap the account avatar and go to Settings > Device settings > Wi-Fi .	Go to  > Settings > Device settings > Wi-Fi (Admin only, default password: admin).

2. Turn on/off **Wi-Fi**.

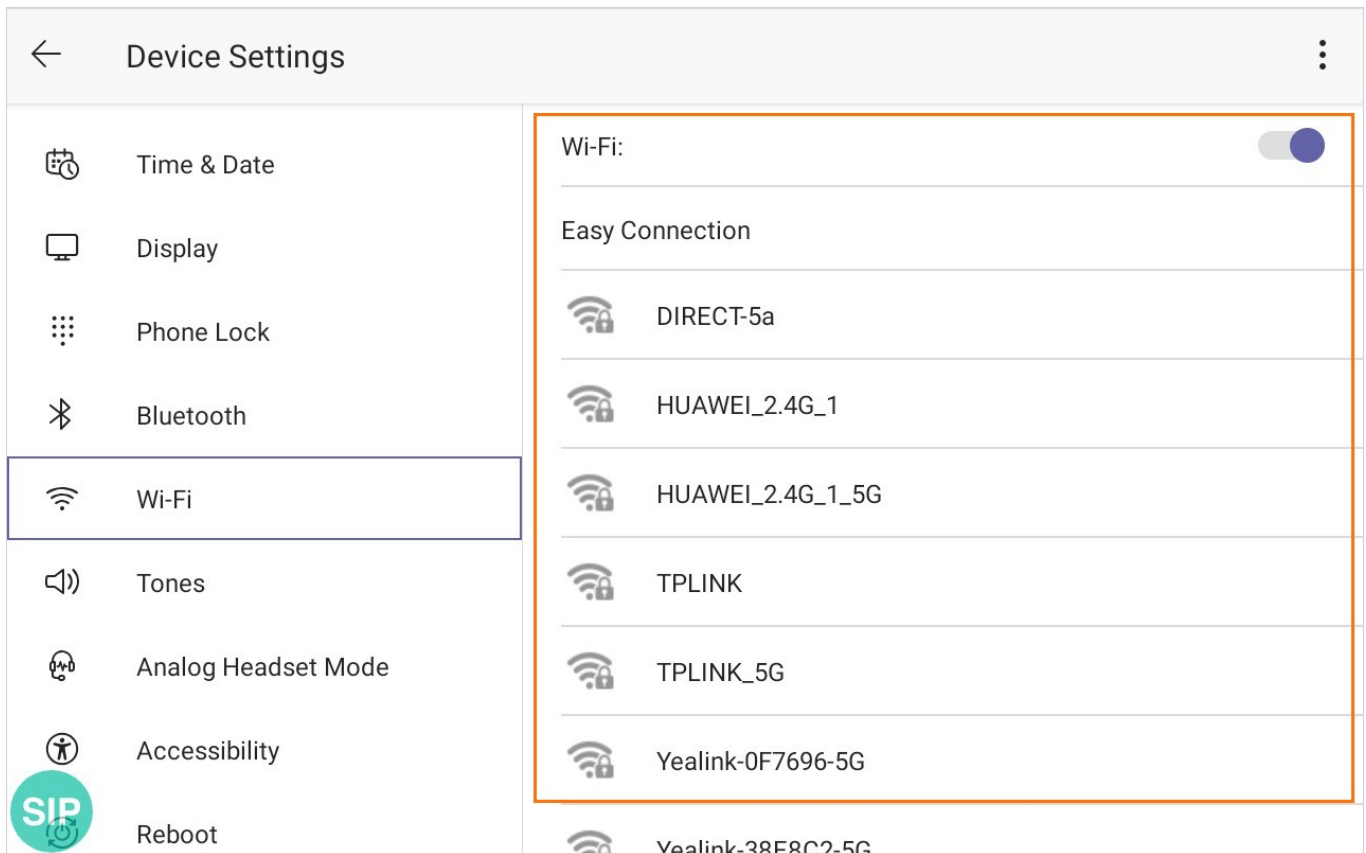



Connect to a Wireless Network Manually

Before you begin

- Make sure that the Wi-Fi mode is **activated**.
- Get the password of the wireless network from your system administrator.

Procedure

1. Select the method according to your device:

VP59/MP58/MP56/MP54/CP965	MP52
<ol style="list-style-type: none"> 1. Tap the account avatar and go to Settings > Device settings > Wi-Fi. 2. Go to  > Scan to search the available wireless network. 	<ol style="list-style-type: none"> 1. Go to  > Settings > Device settings > Wi-Fi (Admin only, default password: admin). 2. Select Scan to search the available wireless network.

2. Select the desired wireless network.
3. If the network is secure, enter its password.
4. Tap **CONNECT** (**JOIN** for MP52).

Add a Wireless Network Manually

If your gateway/router has SSID broadcast disabled, it might not appear in the scanning results. In that case, you must manually add a wireless network.

Before you begin

- Make sure that the Wi-Fi mode is **activated**.
- This feature is unavailable to MP52.

Procedure

1. Tap the account avatar and go to **Settings > Device settings > Wi-Fi**.
2. Go to  > **Add**.
3. Enter the SSID and then select a security mode from the **Security** drop-down menu:
 - If you select **None**, tap **Save**.
 - If you select **WEP** or **WPA/WPA2-PSK**, enter the password and then tap **Save**.
 - If you select **802.1X EAP**, select the desired EAP method and Phase-2 authentication, enter the desired values in the **Identity**, **Anonymous identity**, and **Password** fields and then tap **Save**.

If you enable **Show advanced options**, select a desired value in the **Proxy** field; and if you select **Manual**, enter the information about the proxy server in the corresponding fields.

View the Wireless Network Information

After connecting to the wireless network, you can view the wireless network information (such as wireless status, link speed, security, IP address, signal strength, etc.)

Procedure

1. Select the method according to your device:

VP59/MP58/MP56/MP54/CP965	MP52
Tap the account avatar and go to Settings > Device settings > Wi-Fi .	Go to  > Settings > Device settings > Wi-Fi (Admin only, default password: admin).

2. Select the connected wireless network.
3. (For MP52) Select **Details**.

Disconnect from a Wireless Network

Procedure

1. Select the method according to your device:

VP59/MP58/MP56/MP54/CP965	MP52
<ol style="list-style-type: none"> 1. Tap the account avatar and go to Settings > Device settings > Wi-Fi. 2. Select the connected wireless network. 3. Tap FORGET. 	<ol style="list-style-type: none"> 1. Go to  > Settings > Device settings > Wi-Fi (Admin only, default password: admin). 2. Select the connected wireless network and then select Details. 3. Select FORGET.

The wireless network is disconnected. You can tap it again to connect.

Connect to a Wireless Network Using WPS (Only for CP965)

Wi-Fi Protected Setup (WPS) provides simplified mechanisms to configure secure wireless networks, which can automatically configure a wireless network with a network name (SSID) and strong WPA data encryption and authentication.

About this task

Two methods supported by Yealink devices in the Wi-Fi protected setup:

- **Push Button Configuration (PBC)**: The user simply presses the WPS key on both the device and router to connect.
- **Personal Identification Number (PIN)**: The user has to enter a PIN generated randomly by the device on the router to connect.

NOTE

This feature is only available to CP965.

Connect to a Wireless Network Using PBC

Before you begin

Make sure that the Wi-Fi mode is **activated**.

Procedure

1. Tap the account avatar of the screen and go to **Settings > Device settings > Wi-Fi**.
2. Tap  > **WPS**.

The phone screen prompts that you need to press the Wi-Fi Protected Setup button on your router.

3. Long press the WPS key on your gateway/router.

Once the WPS setup has been completed successfully, the touch screen will prompt connect successfully.

Connect to a Wireless Network Using PIN

Before you begin

Make sure that the Wi-Fi mode is **activated**.

Procedure

1. Tap the account avatar of the screen and go to **Settings > Device settings > Wi-Fi**.
2. Go to  > **WPS-PIN** to search the available wireless network.
3. The phone screen prompts that you need to enter the PIN xxx on your WLAN router.
4. Log into your gateway/router' s web interface, and configure it to search the clients.

Once the WPS-PIN setup completes successfully, the web interface of the gateway/router will prompt success.

Hot Desking

You can sign in to a phone as a guest user. Hot Desking feature is convenient for different employees to share one Teams phone. Any changes you made on the phone while signed in are removed, and the host user settings are restored when you sign out.

NOTE

This feature is unavailable to MP52.

Sign In as a Guest User

You can sign in to Teams on your phone as a guest user.

1. Tap the avatar in the top-right corner of the screen and select **Hot desk**.
2. Enter your user credentials and tap **Sign in**.

Sign Out of the Guest User

You can sign out of the guest user after you use the phone.

1. Tap the avatar in the top-right corner of the screen and select **Stop hot desking**.

The phone prompts you to stop hot desking.

2. Tap **END**.

The guest user is signed out, and the host user is signed in automatically.

TIP

The guest user will automatically be signed out after the phone is idle for a designated time (the system administrator configures this time). Before logout, the phone prompts you that it will automatically sign out in 15 seconds.

Common Area Phone

You can set your phone as a Common Area Phone (CAP). Instead of being located in someone's office, common area phones are typically placed in an area like a lobby or another area that is available to many people to make a call; for example, a reception area, lobby, or conference room.

You have access to certain features for the common area phones:

- **CAP account:** You have calls capability. If your system administrator enables you, you also have the searching capability on the Microsoft Teams Admin Center.
- **Meeting account:** You have call capability and can join the scheduled meeting.

Before You Begin

Make sure that your administrator has [set up a common area phone](#).

Sign In to a CAP/Meeting Account

On Your Teams Device (Unavailable to MP52)

Procedure

1. Select **Sign in**.

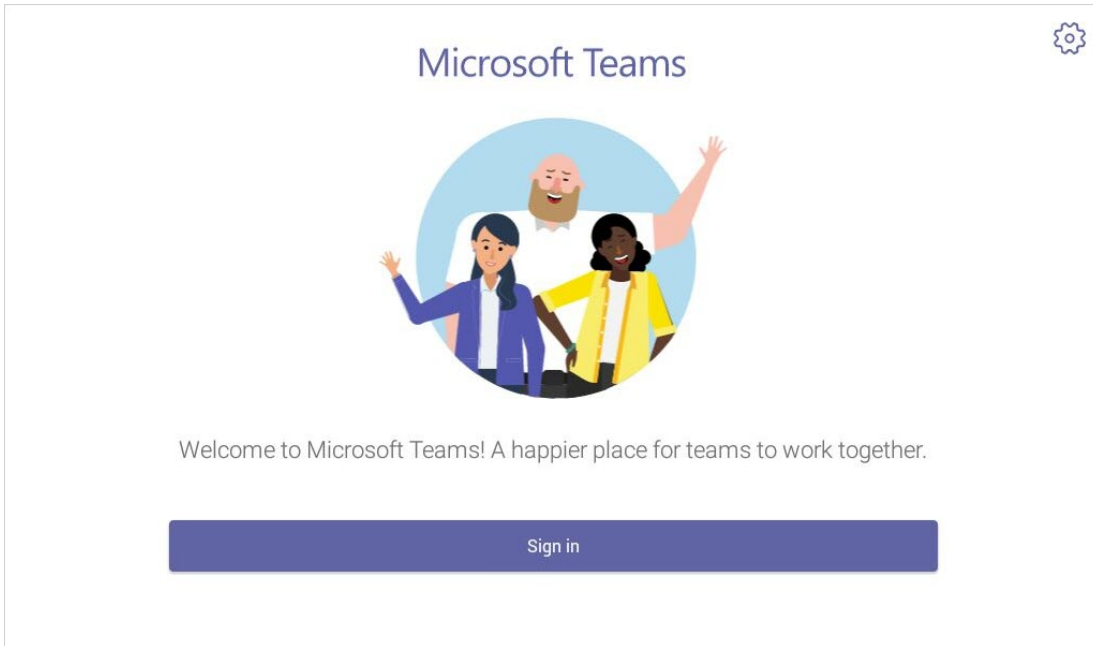

You will be connected to the Company Portal automatically.

2. Enter your user credentials.

3. After the phone signs in successfully, tap **Got it**.

After signing into the CAP account, the screen is displayed as below:

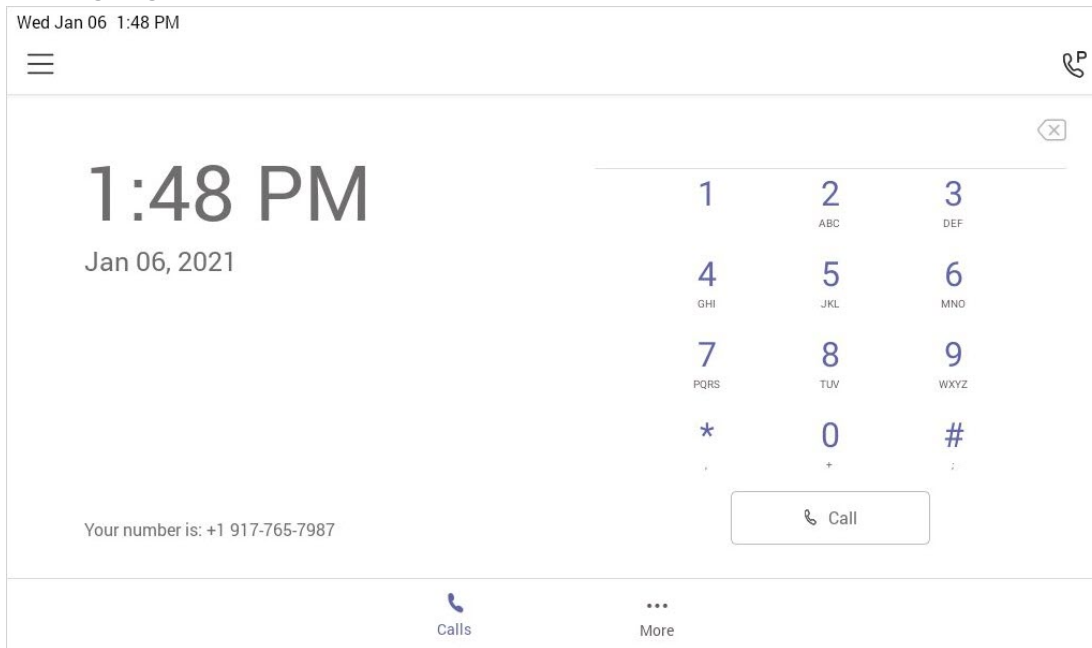

After signing into the Meeting account, the screen is displayed as below:

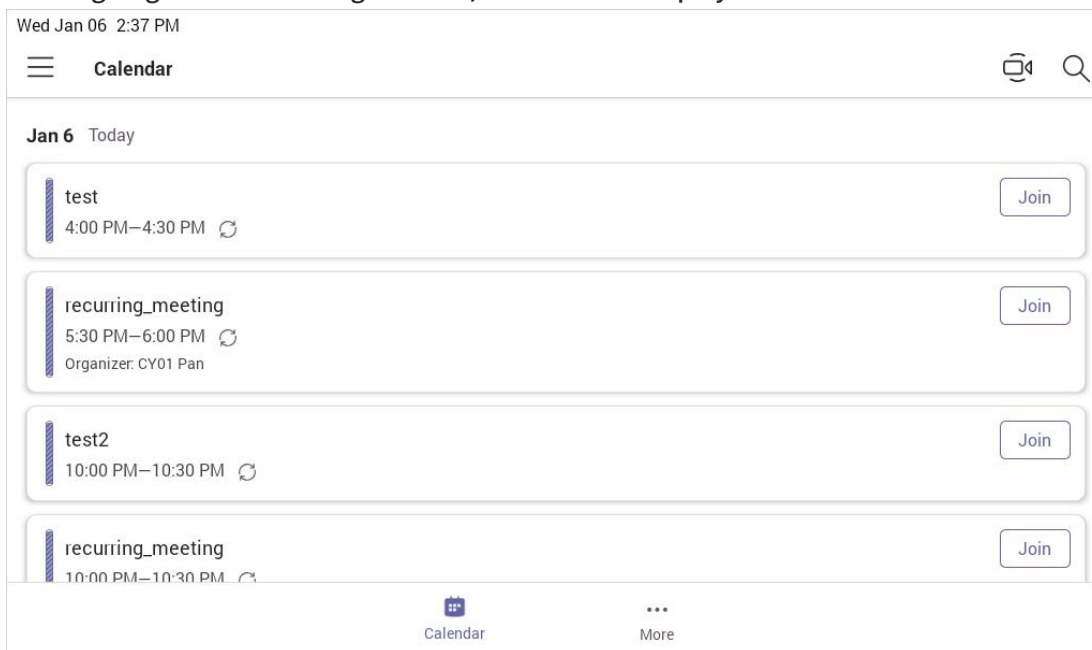

On a Web Browser

Procedure

1. Go to <https://microsoft.com/devicelogin> on your computer or mobile.
2. Enter the code shown on your device and select **Next**.
3. Enter your user credentials or select the desired account to sign in.

A confirmation message is displayed after you successfully sign in to Microsoft Intune Company Portal.

- After the phone signs in successfully, select **Got it**.
After signing into the CAP account, the screen is displayed below:

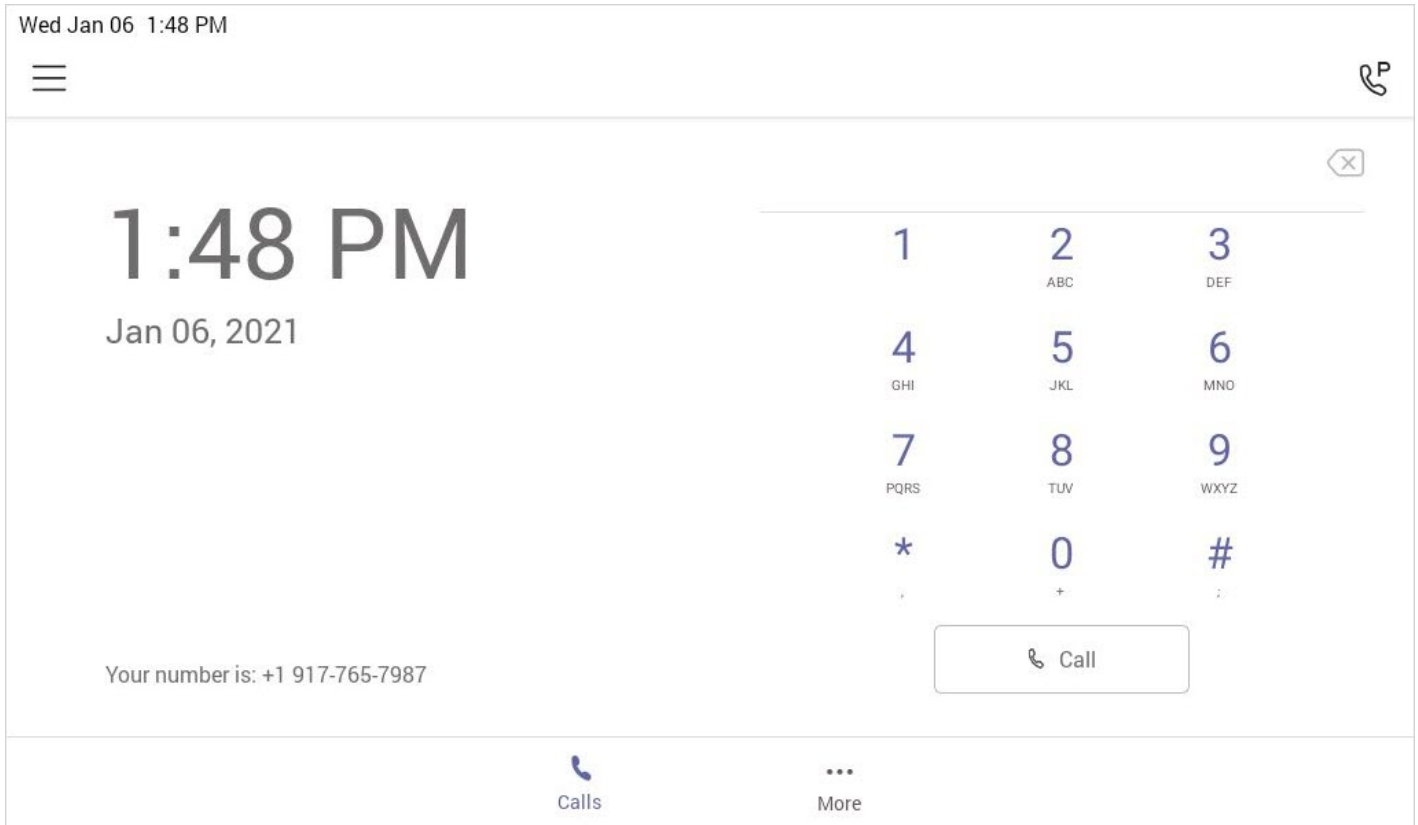

Sign Out of a Common Area Phone

Procedure

- Select the method according to your device:

VP59/MP58/MP56/MP54/CP965	MP52
Tap the account avatar and go to Settings > Device Settings > Teams Admin Settings (Admin only, default password: admin).	Go to  > Settings > Device Settings > Teams Admin Settings (Admin only, default password: admin).

- Select **Teams sign out**.
- Select **OK**.

Hybrid Mode

Overview

After the hybrid mode is enabled, users can receive a paging call in the Teams app mode.

Teams phone supports two hybrid modes: ① Survivability app mode and ② Teams app mode.

If the phone disconnects from the local MS server, you can switch to the survivability app mode to implement the call features.

TIP

The hybrid mode is disabled by default. Contact your system administrator to [enable it](#).

Available Devices

This feature is not available to MP52.

Enable the Quick Ball

You can use the quick ball to quickly switch between the survivability app mode and Teams app mode.

Procedure

1. Tap the account avatar and go to **Settings > Device settings > Hybrid Mode**.
2. Enable **Quick Ball**.

The screen displays a quick ball. You can tap it to change the app mode quickly.

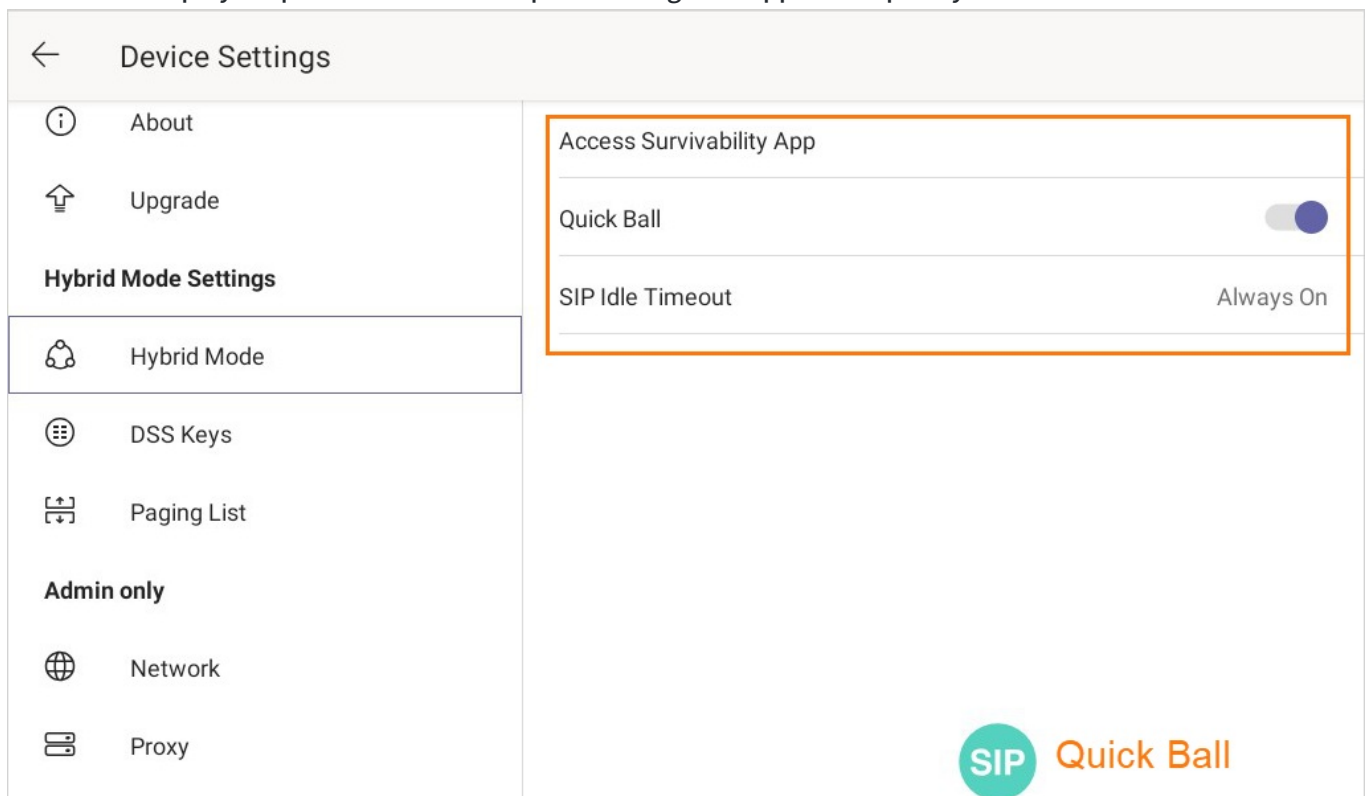

Switch to Teams App

TIP

In a SIP call, the call is placed on hold when you switch to the Teams app mode.

Procedure

1. Tap the quick ball .



Switch to Survivability App

TIP

In a teams call, the quick ball does not appear, so you cannot switch to the survivability app mode.

Procedure



1. Do one of the following:

Method 1	Method 2
1. Tap the quick ball  .	<ol style="list-style-type: none"> 1. Go to  > Settings > Device Settings > Hybrid Mode. For CP965, tap the avatar in the top-right corner of the screen and go to Settings > Device settings > Hybrid Mode. 2. Tap Access Survivability App.

Survivability App Screens

The survivability app includes the following screens:

- **Dial:**

CP965/CP960/M P54	MP5X	VP59
Tap  to open the dialer.	Tap  , pick up the handset, press the headset key, or press the speakerphone key to open the dialer, 2. Tap the corresponding line key to change the account.	Tap  to open the dialer.

- **Directory:** Displays local contacts. You can search for contacts, and manage local directory groups and contacts.
- **History:** Includes missed, placed, received, and forwarded calls. You can view call details and manage the history record.
- **Line Key:** displays the account status, you can expand the line keys list, and the phone supports up to 16 accounts.

Call Features of Survivability App

In survivability app mode, you can perform basic call features.

TIP

If your phone is locked, you may need to unlock it before using call features.

For MP58/MP56/VP59:

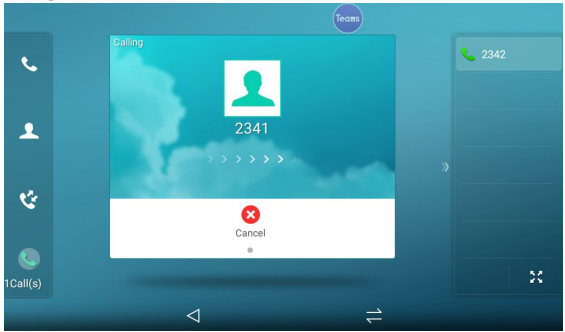
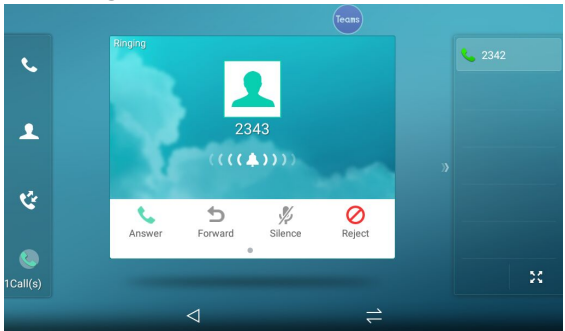
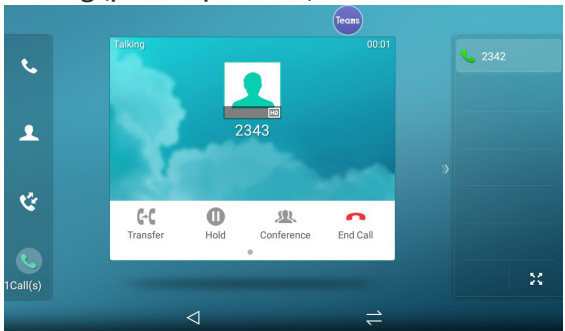
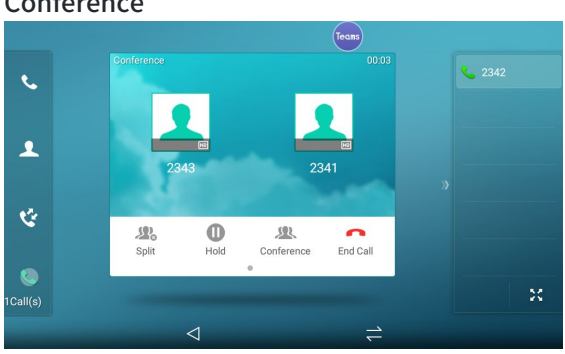
Call Status for MP58/MP56/VP59	You can
<p>Ring back</p> 	<p>Cancel a call</p>
<p>Incoming Call</p> 	<ul style="list-style-type: none"> • Answer a call • Reject a call • Silence a call • Forward a call
<p>Talking (peer to peer call)</p> 	<ul style="list-style-type: none"> • End a call • Mute a call • Hold a call • Transfer a call • Place a new call • Invite a new party
<p>Conference</p> 	<p>For the conference originator:</p> <ul style="list-style-type: none"> • End a conference call • Mute a conference call • Hold a conference call • Place a new call • Invite a new party • Split a Conference Call <p>For other conference participants: the same as the peer-to-peer call.</p>

For MP54/CP965/CP960:

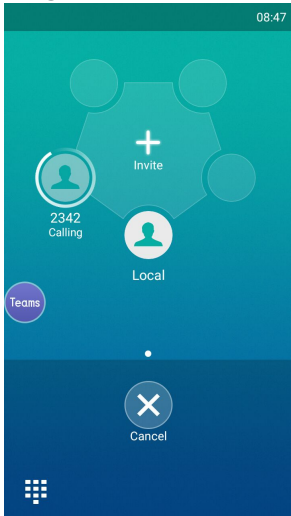
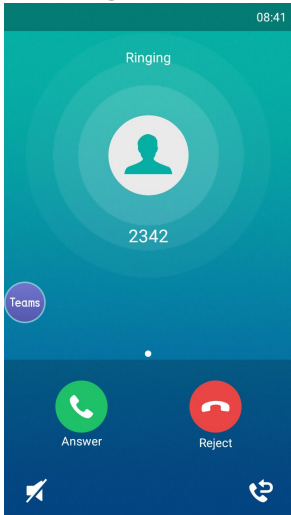
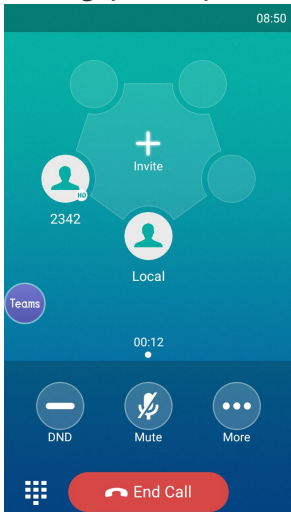
Call Status for MP54/CP965/CP96	You can
<p>Ring back</p> 	<ul style="list-style-type: none"> • Cancel a call • Invite a new party
<p>Incoming Call</p> 	<ul style="list-style-type: none"> • Answer a call • Reject a call • Silence a call • Forward a call
<p>Talking (peer to peer call)</p> 	<ul style="list-style-type: none"> • Enable DND • End a call • Mute a call • Hold a call • Transfer a call • Place a new call • Invite a new party

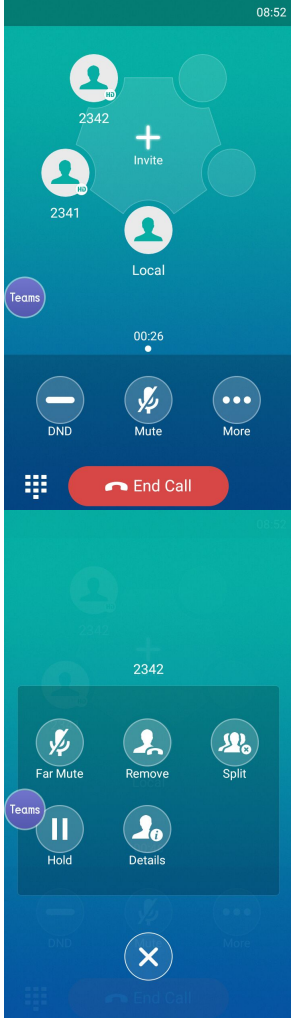

For the conference originator:

- Enable DND
- End a conference call
- Mute a conference call
- Hold a conference call
- Place a new call
- Invite a new party
- Split a Conference Call
- Manage a participant:
 - Mute the participant
 - Remove the participant
 - Split the participant
 - Hold the participant
 - View the detail of participant

For other conference participants: the same as the peer-to-peer call.

FAQ

Why does the phone returns to Teams mode after I reboot the phone?

If you enable the Hybrid mode, the phone will return to the Teams mode once you reboot the phone. To use the SIP mode, please [switch to Survivability App](#).

Use Cascaded Mode (CP965&CP960 Only)

Join a Cascaded Mode

You can deploy up to four CP965 phones in a cascaded layout. In the cascaded group, one phone acts as a primary phone, while others act as satellite phones. The primary phone keeps all features, while the satellite phones only sync some key features of the primary phone, such as the calling feature. After connecting, satellite phones are

mainly used as speakers or microphones.

NOTE

Ensure all the phones are deployed in the same subnet and running the same firmware versions.

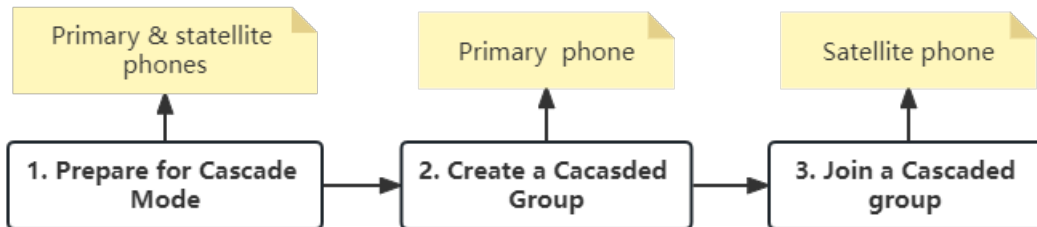

Prepare for Cascaded Mode

The following instructions you need to know when configuring cascaded mode for CP965/CP960:

- Ensure all the phones are deployed **in the same subnet**.
- Ensure all the phones are **running the same firmware versions**.
- You can only deploy the CP965/CP960 phones in a star layout **in the wired network**.
- If the primary phone is not in the broadcast status, the satellite phones will not reconnect automatically after reboot.
- The satellite phones cannot sync some custom features of the primary phone, for example, wallpaper or contact avatar.
- You cannot access the web user interface of the satellite phones.
- If you upgrade firmware via the web user interface for the primary phone, only the primary phone will be upgraded. After upgrading, the satellite phones are disconnected from the primary phone because of the different firmware versions.
- If you upgrade firmware via auto provisioning, the primary and the satellite phones will be upgraded.

Create a Cascaded Group

If your system administrator has not specified your phone as a primary phone, you need to create a cascaded group on your phone manually. After you create a cascaded group, you can make the primary phone send broadcast to wait for other satellite phones to join the cascaded group.

Procedure

1. Tap the account avatar and go to **Settings > Device settings > Admin only** (default password: admin) > **Cascaded Mode > Create Group**.

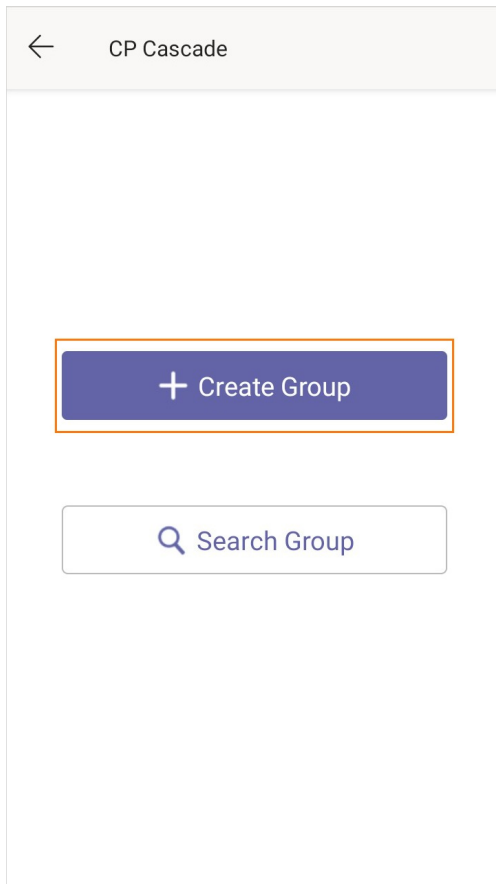

2. Tap **Broadcast**.

The phone automatically generates a four-digit PIN and sends the broadcast.



Join a Cascaded Group

You can join your phone to a cascaded group as a satellite phone.

NOTE

- Make sure that the primary phone [has set up a cascaded group and is broadcasting](#) .
- One CP960/CP965 phone can only join one cascaded group.

Procedure

1. Tap the account avatar and go to **Settings > Device settings > Admin only** (default password: admin) > **Cascaded Mode > Search Group**.

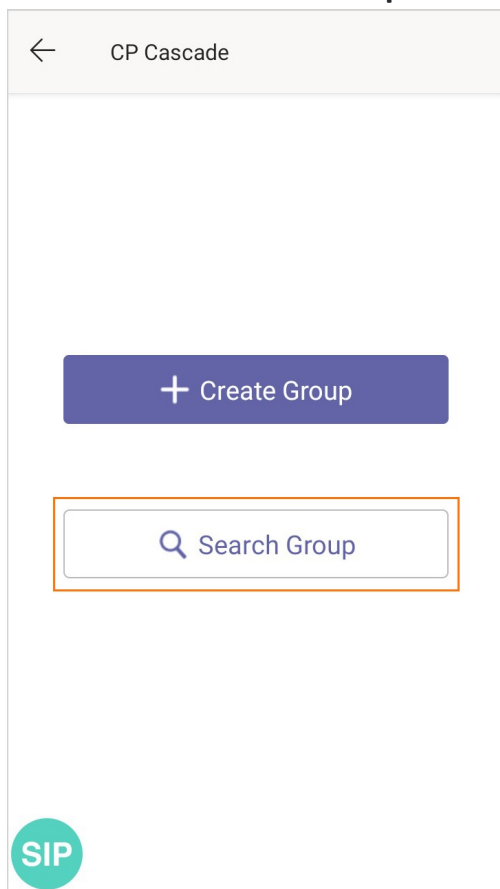

2. Select **Join** and enter the PIN number displayed on the primary phone.

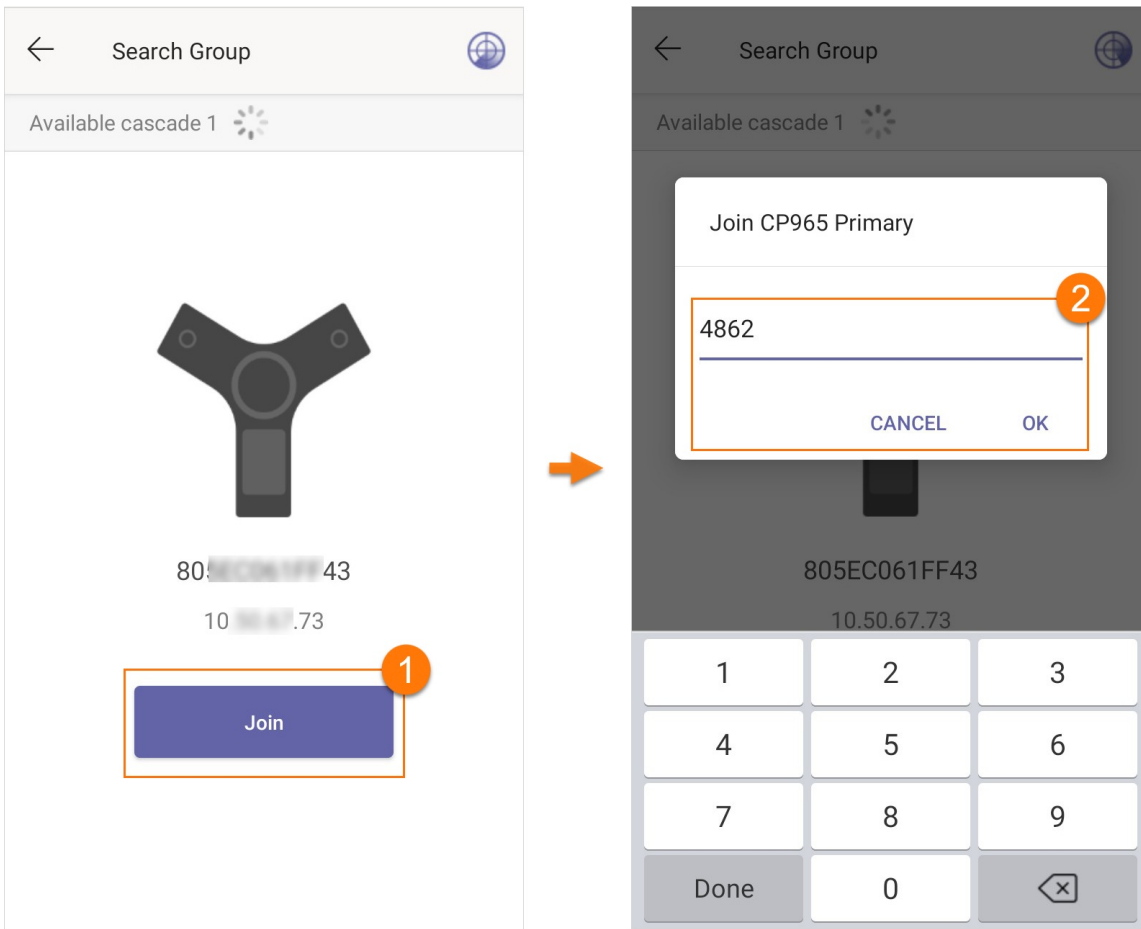

After reboot, the satellite phone joins the cascaded group successfully.

The cascaded name (for example, CP960-S1) is displayed on the idle screen of the primary phone, and a cascaded icon appears in the status bar.

Screen of Primary phone	Screen of Satellite phone
-------------------------	---------------------------

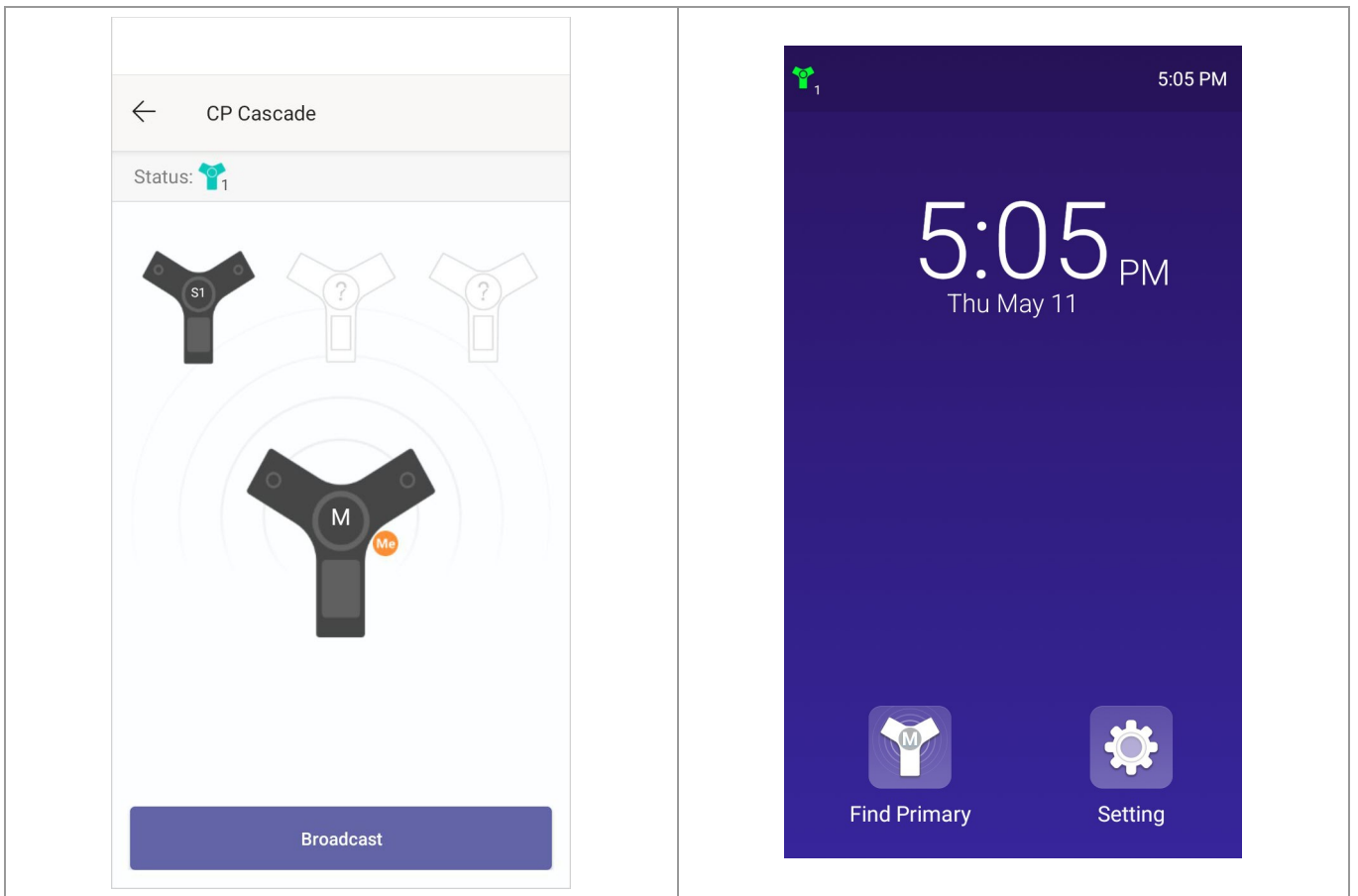

FAQ

Why can't I find the Cascaded Mode menu?

Make sure that you do not enable Wi-Fi. If enabled, the cascaded mode is unavailable. You need to go to the phone web user interface to **deactivate** the Wi-Fi.

1. Log in to the web user interface.
2. Go to **Network > Wi-Fi**.
3. Deactivate the Wi-Fi mode.

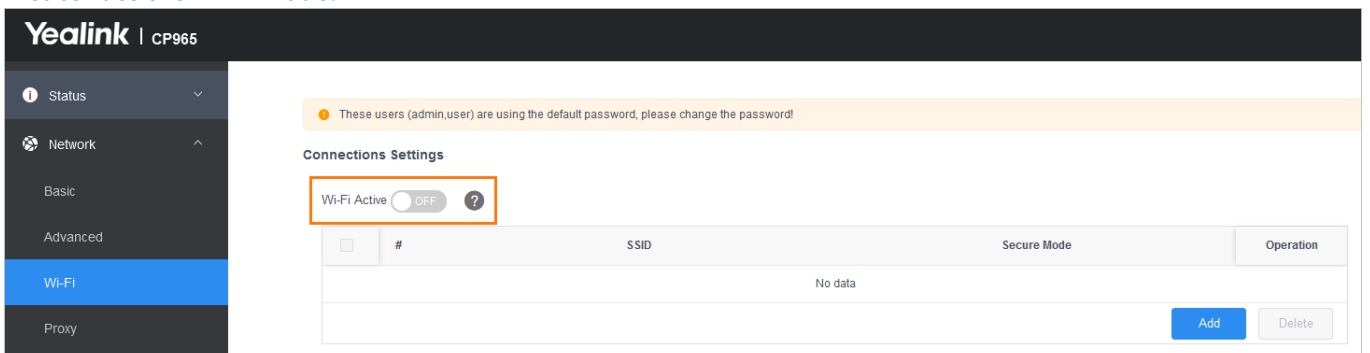

Why can't I find the primary phone?

Ensure the satellite and the primary phone use the same firmware version. Otherwise, the satellite phone cannot join the cascaded group created by the primary phone.

Operations on the Primary Phone

You can set up a cascaded group, remove any satellite phone, and dissolve a cascaded group. You can also quickly find a satellite phone.

Remove a Satellite Phone

You can remove a satellite phone from the cascaded group.

Procedure

1. Tap the account avatar and go to **Settings > Device settings > Admin only** (default password: admin) > **Cascaded Mode**.
2. Select the desired satellite phone.
3. Select **Remove**.

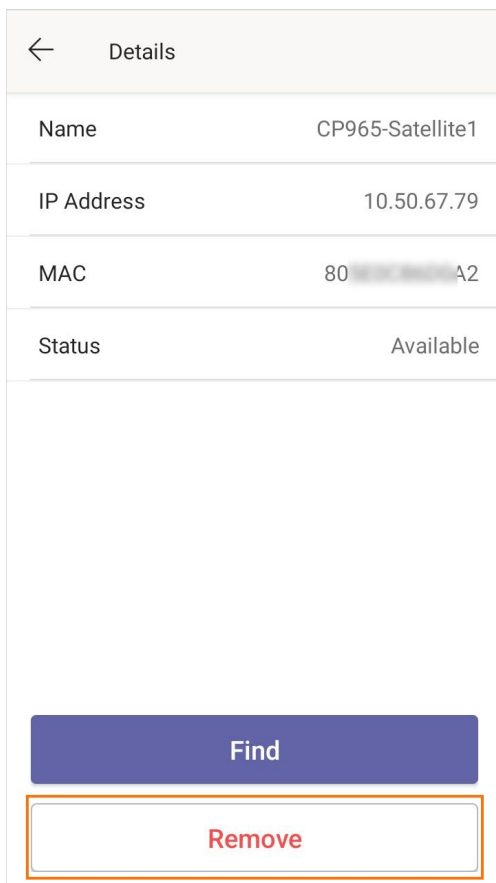

The phone prompts you to remove the satellite phone or not.

4. Select **OK**.

The satellite phone is removed from the cascaded group successfully.

Dissolve a Cascaded Group

You can dissolve a cascaded group when the phone no longer needs the connection.

Procedure

1. Tap the account avatar and go to **Settings > Device settings > Admin only** (default password: admin) > **Cascaded Mode**.
2. Tap the primary phone icon.

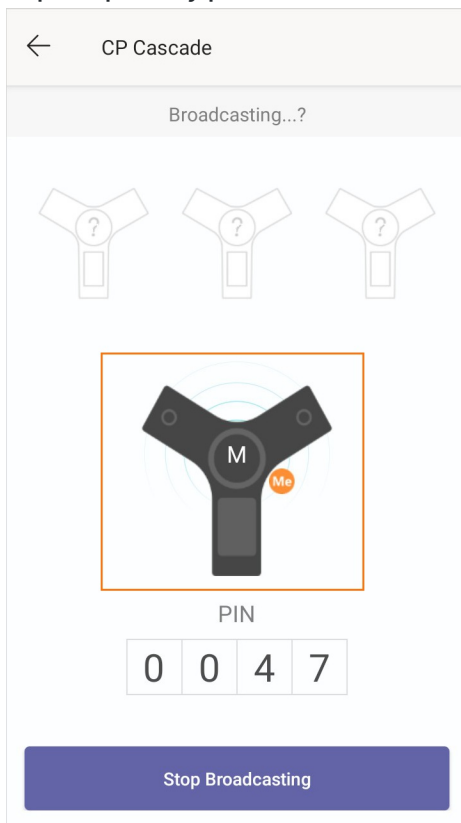

3. Select **Dissolve Group**.

The phone prompts you to dissolve the cascaded group or not.

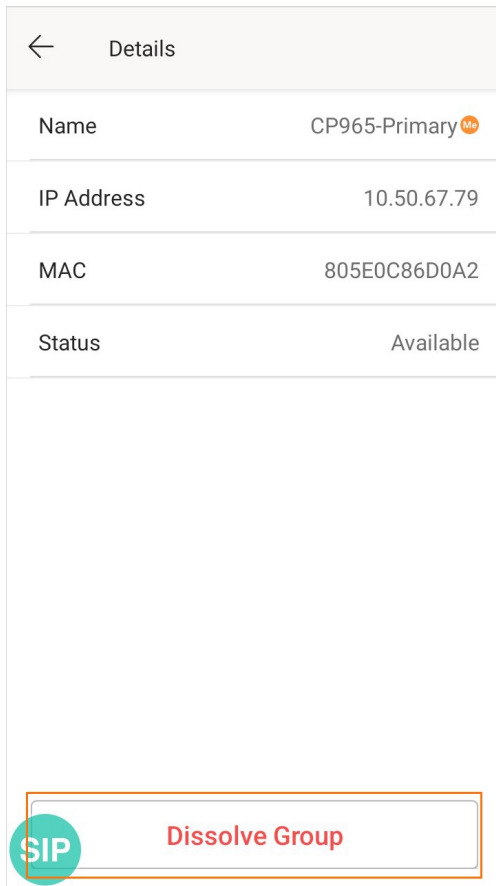

4. Select **OK**.

The phone dissolves the cascaded group successfully.

Find a Satellite Phone

You can find the satellite phones which join the cascaded group on the primary phone.

Procedure

1. Tap the account avatar and go to **Settings > Device settings > Admin only** (default password: admin) > **Cascaded Mode**.

2. Tap the desired satellite phone.



3. Select **Find**.

The primary phone will automatically find the satellite phone in your area. The satellite phone will play the ring tone, and the mute key LED indicators will flash green and red alternately.

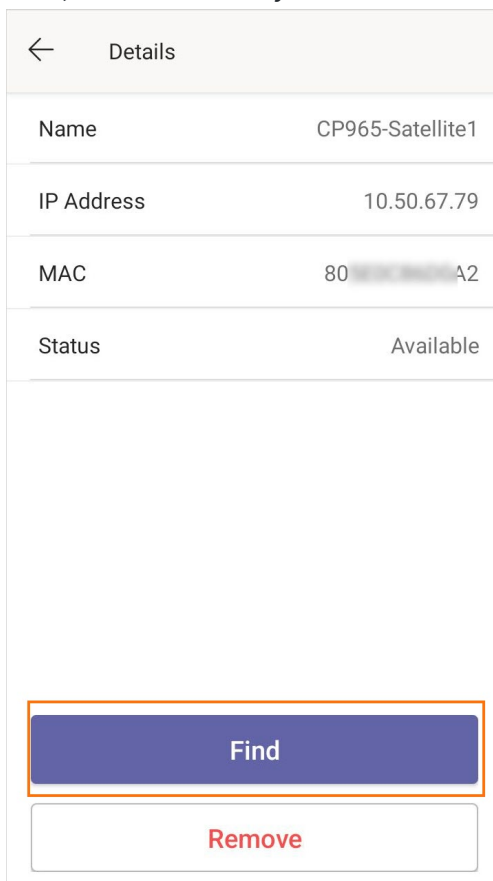

Stop Finding a Satellite Phone

If you find your satellite phone, you can manually stop finding other satellite phones on the primary phone.

Procedure

1. Tap the account avatar and go to **Settings > Device settings > Admin only** (default password: admin) > **Cascaded Mode**.
2. Tap the desired satellite phone.
3. Select **Exit** on the primary phone.

The satellite phone will stop ringing.

TIP

You can also stop finding a satellite phone by tapping any touch key on the satellite phone.

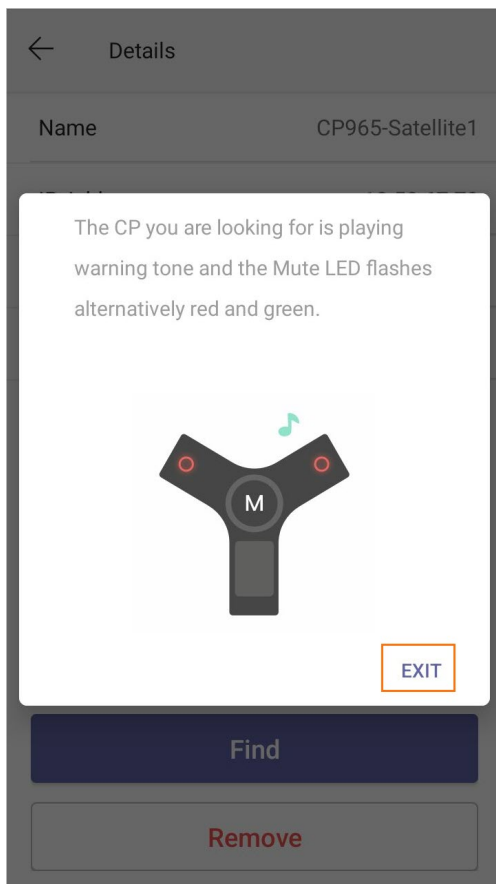

Operations on the Satellite Phone

You can join or quit a cascaded group on the satellite phone. You can also quickly find a primary phone.

Quit a Cascaded Group

You can quit a cascaded group when you need to use your phone as a normal conference phone.

Procedure

1. Tap the account avatar and go to **Settings > Admin only** (default password: admin) > **Cascaded Mode**.

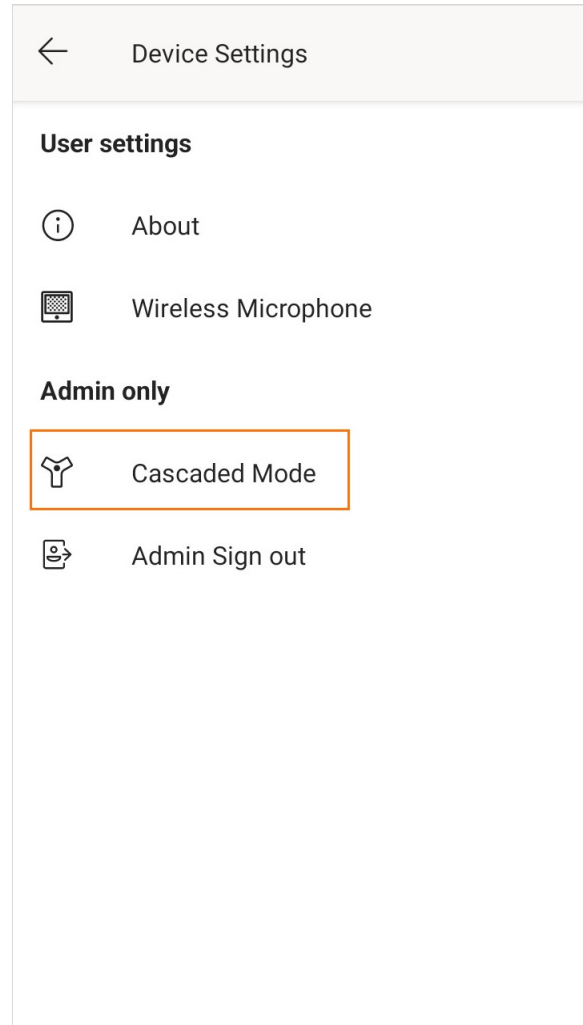
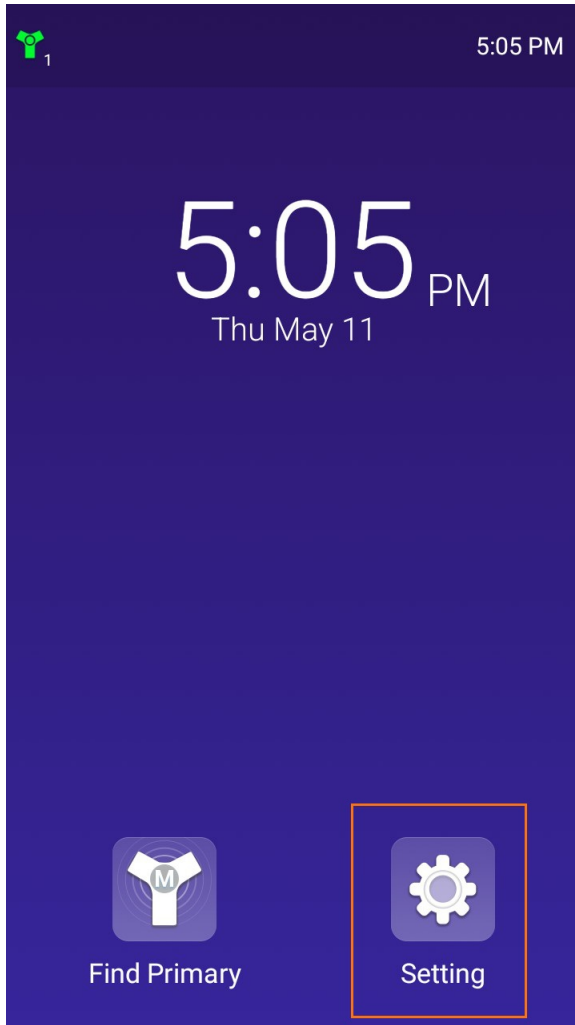

2. Tap the desired satellite phone.



3. Select **Quit Group**.

The phone prompts you to quit the cascaded group or not.

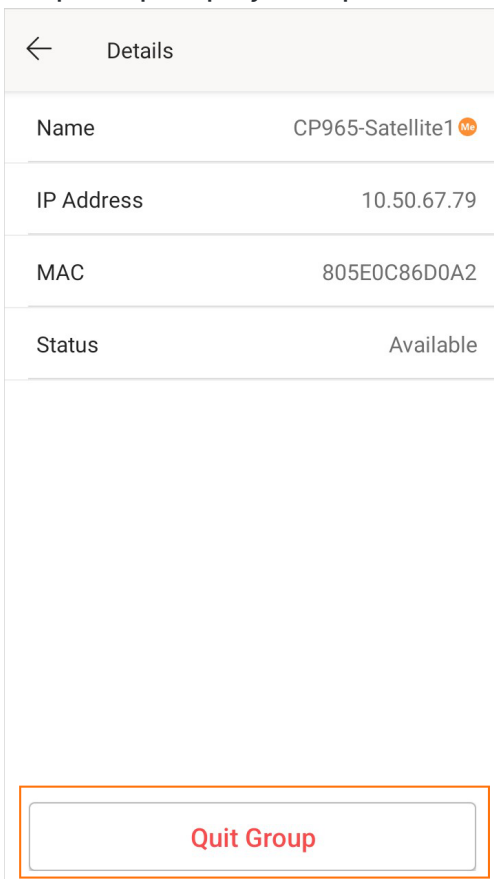

4. Select **OK**.

After reboot, the phone quits the cascaded group successfully.

Find a Primary Phone

You can confirm the actual location of the primary phone on any satellite phone.

Procedure

1. Tap the account avatar and go to **Settings > Admin only** (default password: admin) > **Cascaded Mode**.
2. Tap the primary phone.



3. Select **Find**.

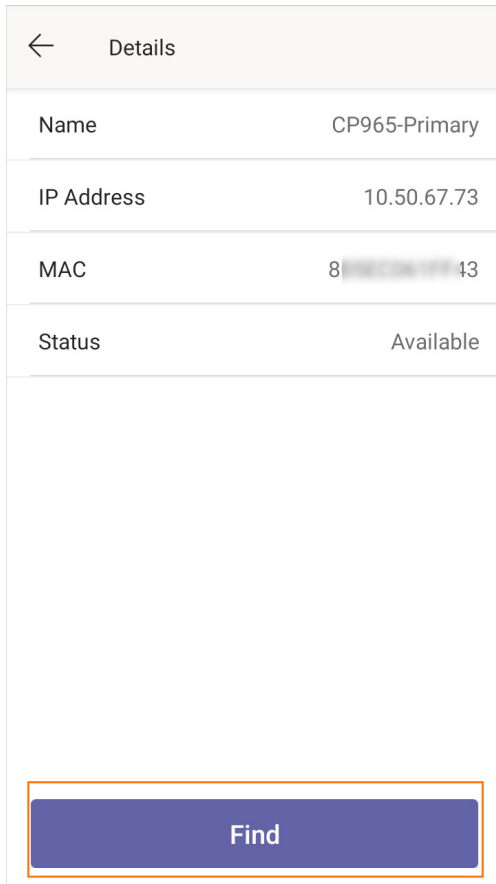

← Details	
Name	CP965-Primary
IP Address	10.50.67.73
MAC	8:XXXXXXXX:43
Status	Available

Find

The satellite phone will automatically find the primary phone in your area. The primary phone will play the ring tone, and the mute key LED indicators flash green and red alternately.

Stop Finding a Primary Phone

If you find your primary phone, you can manually stop finding the primary phone at any time.

Procedure

1. Tap the account avatar and go to **Settings > Admin only** (default password: admin) > **Cascaded Mode**.
2. Tap the primary phone.

3. Select **Exit** on the satellite phone.

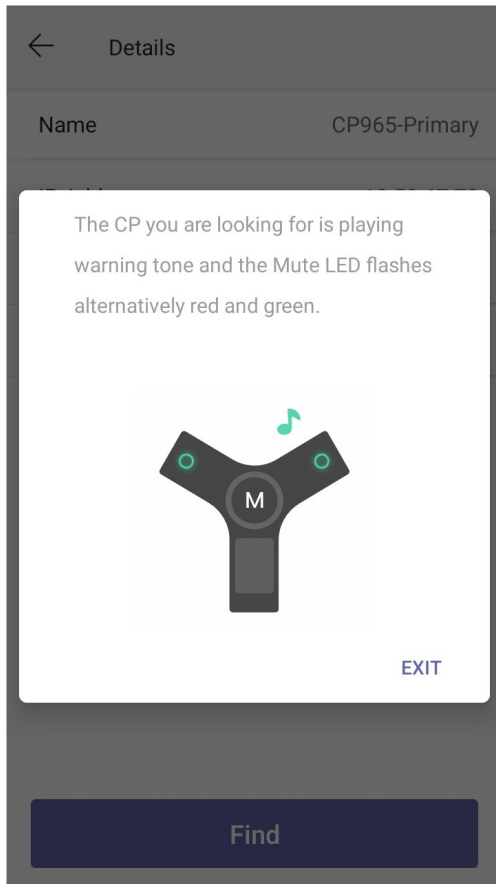

The primary phone will stop ringing.

TIP

You can also stop finding a primary phone by tapping any touch key on the primary phone.

Multicast Paging

Introduction

Your phone supports up to 31 groups for paging. You can assign a label to each group to identify the phones, such as All, Sales, or HR.

You can set a line key as a Paging key or Paging List key on the phone, which allows you to send announcements to the phones with pre-configured multicast address(es) on a specific channel(s).

It is available only when your administrator has [set up the multicast paging feature](#).

Paging Key

Set a Paging Key

You can set a Paging key for a paging group, which allows you to send announcements quickly on the idle screen.

Procedure

1. Tap the account avatar and go to **Settings > Device settings > DSS Keys**.
2. Select the desired line key.
3. Select **Key Event** from the **Type** field.
4. Select **Paging** from the **Key Type** field.
5. (Optional) Enter the paging group name in the **Label** field.
6. Enter the multicast IP address and port number (for example, 224.5.6.20:10008) in the **Value** field.
7. Enter the desired channel between 0 and 30 in the **Channel** field.

DSS Key	Dss Key 1
Type	Key Event
Key Type	Paging
Label	<input type="text" value="paging"/>
Value	<input type="text" value="224.5.6.20:10008"/>
Channel	<input type="text" value="0"/>

8. Save the change.

Send a Paging by a Paging Key

You can send paging using the Paging key when the phone is idle.

Procedure

1. Switch to the survivability App.

2. Tap the Paging key when the phone is idle.

For MP58/MP56/VP59:

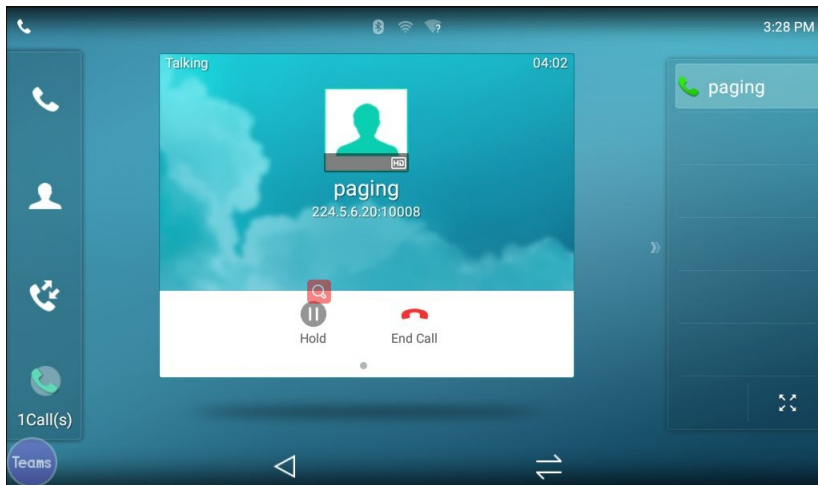

For MP54/CP965/CP960:



Paging List Key

Set a Paging List Key

You can use the quick ball to quickly switch between the survivability app mode and the teams app mode.

Procedure

1. Tap the account avatar and go to **Settings > Device settings > DSS Keys**.
2. Select the desired line key.
3. Select **Key Event** from the **Type** field.
4. Select **Paging** from the **Key Type** field.
5. (Optional) Enter the paging group name in the **Label** field.

6. Save the change.

← DSS Keys	
DSS Key	Dss Key 1
Type	Key Event
Key Type	Paging List
Label	paging list

Set a Paging Group

Procedure

1. Tap the account avatar and go to **Settings > Device settings > Paging List**.
2. Select the desired line key.

The default tag is Empty if it is not configured before.

3. Enter the multicast IP address and port number (for example, 224.5.6.20:10008) in the **Address** field.
4. Enter the string displayed on the phone screen in the **Label** field.
5. Select the desired channel between 0 and 30 in the **Channel** field.
6. Save the change.

Send a Paging by a Paging List Key

You can send a paging by using the Paging List key when the phone is idle.

Procedure

1. Switch to the survivability App.
2. Tap the Paging List key when the phone is idle.
 - Tap the desired paging group.
 - Long tap the desired paging group and select **Paging**.

Edit a Paging Group

You can edit the information of the paging group.

Procedure

1. Tap the account avatar and go to **Settings > Device settings > Paging List**.
2. Long tap the desired paging group and select **Edit**.

3. Edit the information.
4. Save the change.

Delete a Paging Group

You can delete any group from the paging group list.

Procedure

1. Tap the account avatar and go to **Settings > Device settings > Paging List**.
2. Long tap the desired paging group and select **Delete**.

The phone prompts you to delete the paging group.

3. Select **OK**.

Receive Multicast Paging

If your system administrator has set a listening paging group for you, you can automatically receive a paging call when the phone is idle.

USB Audio Mode (CP965&CP960 Only)

You can connect the CP960/CP965 phone to the PC using a micro USB cable. The phone will automatically enter the USB audio mode when a call is in progress on the Microsoft Teams client.

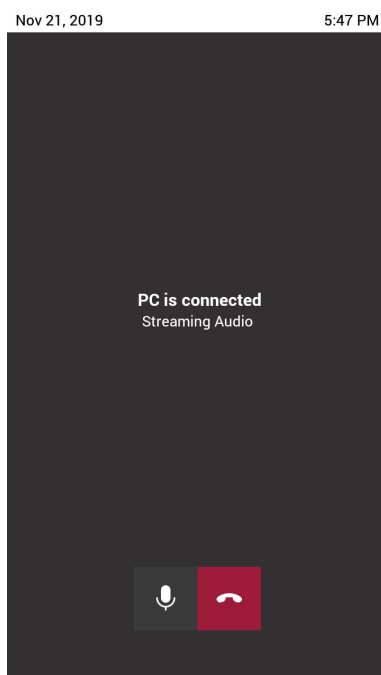

Procedure

In the USB audio mode, you can only mute the call or end the call.

TIP

If there is another incoming Teams/SIP call, the current call will be paused. After the Teams/SIP call ends, you can resume the call on the Microsoft Teams client. The phone enters the USB audio mode again.

Maintain Teams Devices

When the phone cannot be operated properly, you can investigate or troubleshoot issues along with any other tasks your administrator may ask you to perform.

Reboot Your Device

Your system administrator may ask you to reboot your device if it malfunctions or to assist in troubleshooting.

Procedure

1. Select the method according to your device:

VP59/MP58/MP56/MP54/CP965	MP52
Tap the account avatar and go to Settings > Device Settings > Reboot.	Go to  > Settings > Device Settings > Reboot.

2. Tap **Reboot phone.**

It prompts if you are sure to reboot the device.

3. Tap **OK.**

View Device Status

Your system administrator may ask you to view the phone status such as network, MAC, firmware, Partner APP version, Company Portal version, and Teams version.

Procedure

1. Select the method according to your device:

VP59/MP58/MP56/MP54/CP965	MP52
Tap the account avatar and go to Settings > Device Settings > About.	Go to  > Settings > Device Settings > About.

Reset Your Device

You can reset the device to factory settings with the need for entering the Administrator's password.

TIP

For MP5X/VP59, you can also long press the pound key (#) and the star key (*) for about 6 seconds to reset the phone to factory settings when the phone is idle.

Procedure

1. Select the method according to your device:

VP59/MP58/MP56/MP54/CP965	MP52
Tap the account avatar and go to Settings > Device Settings > Debug (Admin only, default password: admin) .	Go to  > Settings > Device Settings > Debug (Admin only, default password: admin) .

2. Select **Reset to Factory Settings**.

It prompts if you are sure to reset to factory default.

3. Tap/Select **OK**.

Accessories

Use CP900&CP700

You can connect a USB speakerphone CP900/CP700 on the phone to control calls by USB or Bluetooth.

NOTE

CP900/CP700 is only available to MP58, MP56, MP54, VP59.

Procedure

You can do the following:

- Tap the **Answer Call** button to answer a call.
- Tap the **End Call** button to reject or end a call.
- Tap the **Mute** button to mute the microphone.
- Tap the **Volume Up/Volume Down** button to adjust the volume.

TIP

The volume will be synchronized between the speakerphone and the phone. For more information, refer to [Yealink USB Speakerphone CP700 & CP900 User Guide](#).

Use EXP50 Expansion Module

Introduction

When connecting the EXP50 expansion module to your phone, you can specify the group of Teams contacts to display on the EXP50 expansion module. Therefore, you can quickly call the contact by pressing the corresponding EXP key. You can also view your Teams contacts' presence from your expansion module.

Supported Phones

EXP50 expansion module is available to MP58, MP56 and VP59.

How to Connect EXP50

To easily connect the EXP50 to the phone, please unplug the phone stand from the IP phone.

Step 1: Unplug the stand from the IP phone

1. Unplug the power adapter and Ethernet cable from the IP phone.
2. Unplug the handset attached to the IP phone.
3. Turn the IP phone over and lay it on a non-slip, flat surface.
4. Unplug the stand from the IP phone.

Step 2: Connect the EXP50

NOTE

Power is automatically transferred from the host phone to the expansion module(s) upon connection. If you want to use more than one expansion modules on a single phone, you need to connect an additional Yealink power adapter (5V/2A) to any one of the expansion modules.

The power adapter should be purchase separately.

1. Turn over the phone and expansion module, and lay them on a flat, non-flat, non-slip surface.
2. (Optional.) The slots of IP phone may be plugged up by silica gel. You can pull out the silica gel.

3. Connect the EXP50 color-screen expansion module and the IP phone using the supplied connecting sheet and screw.

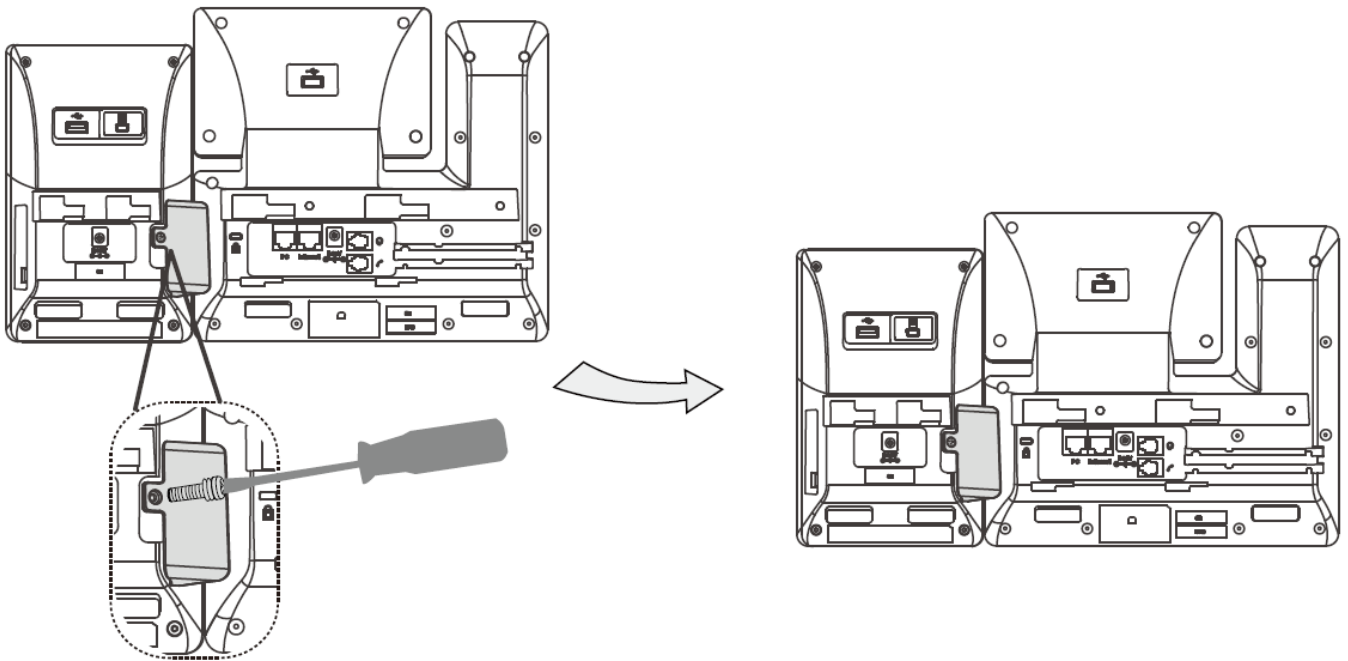

If you want to connect two or more expansion modules, pull out the silica gel and connect two expansion modules as below.

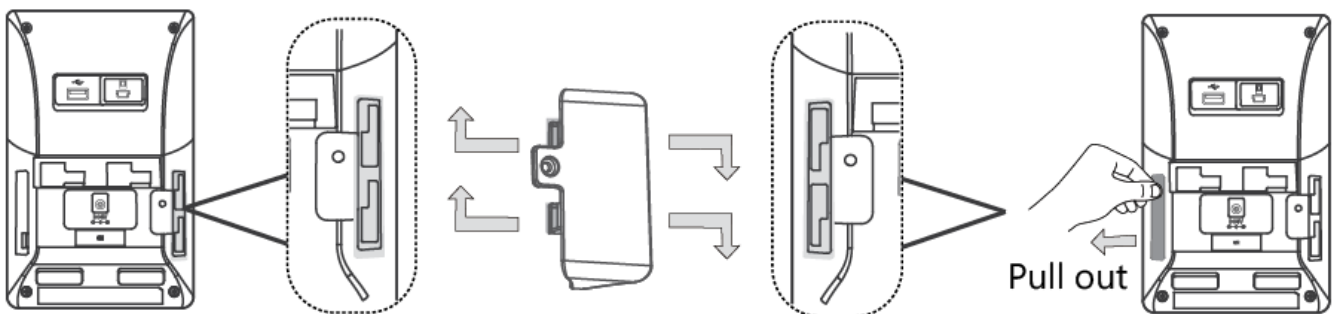

Connecting two expansion modules on a single host phone is shown as below:

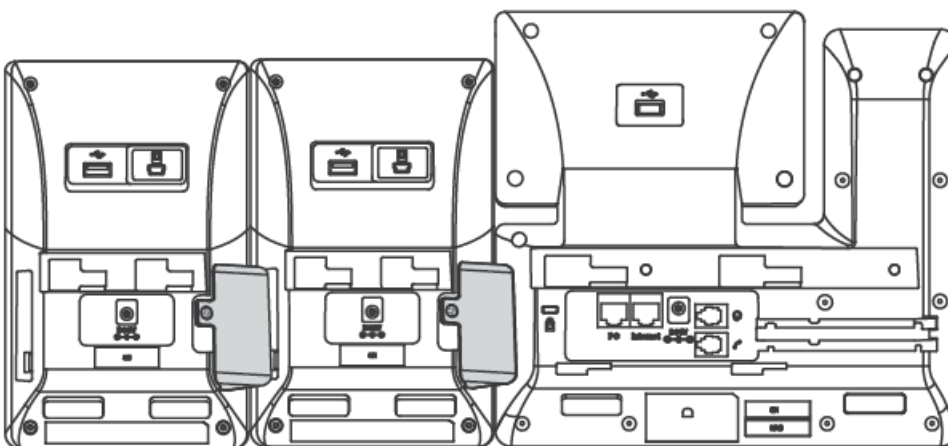

4. Connect the USB jack on the host phone and the mini USB jack on the expansion module using one supplied cable.

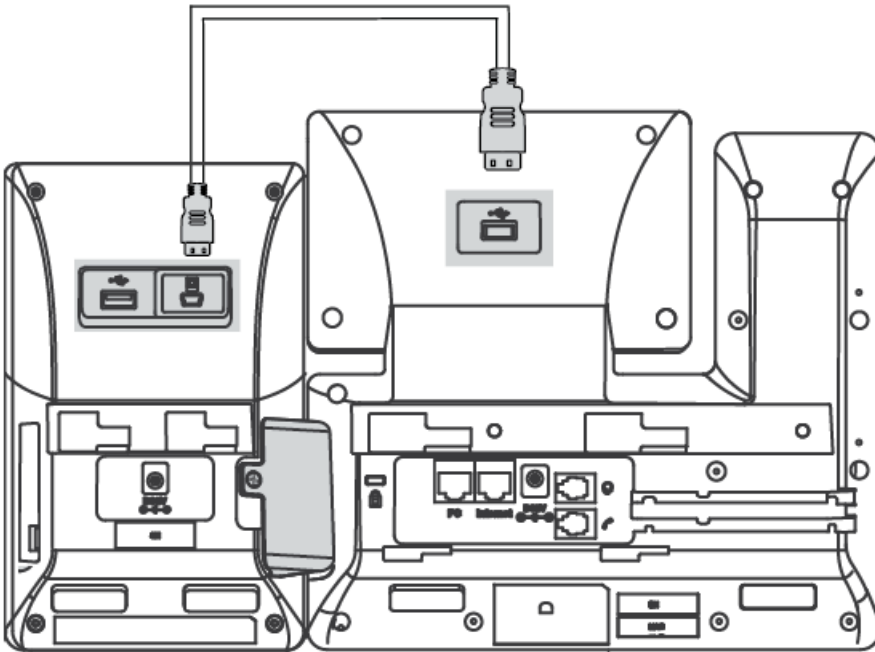

If you connect two expansion modules, connect the USB jack on the prior expansion module and the mini USB jack on the next expansion module using another supplied cable. Connecting two expansion modules on a single host phone is shown as below:

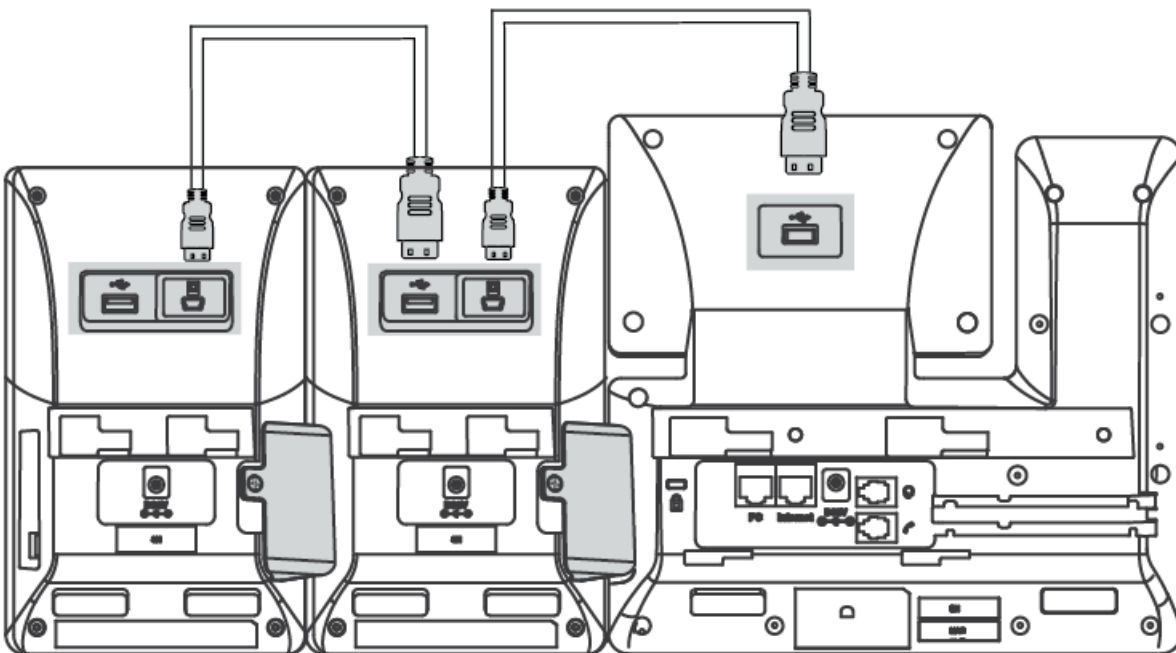

How to Use

1. Connect the expansion module to the phone use a USB cable.
2. From **People** screen, select **⋮ > Edit group**.
3. Select a desired Teams group.

4. Select **Pin group to sidecar**.

The contacts will be displayed on the EXP50 expansion module.

5. Press the corresponding EXP key to call the contact.

For more information, see EXP50 user guide.

EXP Key LED Indicators

The EXP key LED indicators on the EXP40/EXP50 expansion module:

LED Status	Description
Green	The Teams contact is available.
Red	<ul style="list-style-type: none"> • The Teams contact is busy. • The Teams contact is busy. • The Teams contact is Do Not Disturb. • The call of your Teams contact is parked. • The call of your Teams contact is placed on hold. • The held call of your Teams contact is resumed. • The Teams contact is in a Teams conference.
Yellow	<ul style="list-style-type: none"> • The Teams contact is busy. • The Teams contact is right back. • The Teams contact is off work. • The Teams contact is away.
Off	<ul style="list-style-type: none"> • The Teams contact is unknown. • The Teams contact is offline. • Your phone is locked.

FAQ

How Many Contacts Can You Expand When Using EXP50?

60 contacts.

Its 60 line keys on the 3 pages (20 keys per page) allow you to extend the functionality of Yealink T56A/T58A/VP59/MP56/MP58/MP58-WH Teams phones to EXP50.

How Many EXP50 Can you Connect?

You can connect up to 3 units of EXP50.

Use Bluetooth Headsets

You can use a Bluetooth headset to handle calls on the phone.

For more information, refer to the documentation from your Bluetooth headset manufacturer.

NOTE

This feature is unavailable to CP965/CP960.

Use USB Headsets

You can use a USB headset to handle calls on the phone.

For the supported headsets, refer to [Tested headset list compatible with Yealink IP Phone](#).

USB headsets that are not listed may not function properly if you connect them to your phone. For more information on how to use your USB headset, refer to the related documentation from the manufacturer.

NOTE

This feature is not available to CP965/CP960.

Use Wireless Headsets

You can use most wireless headsets with your phone.

EHS40 provides the technical interface between your phone and an EHS-compatible wireless headset, such as Sennheiser/Jabra (GN Netcom) or Plantronics headset. After the EHS40 and your headset are connected successfully, you can handle calls by your headset.

For more information on how to connect EHS40, see the EHS40 User Guide on [Yealink Technical Support](#) page. For more information on how to use your headset, refer to the related documentation from the manufacturer.

Use Yealink BTH58

You can use Yealink Bluetooth Wireless Handset BTH58 instead of wired handset.

NOTE

It is only available to MP58-WH.

Place the handset on the phone handset cradle, three scenarios as below:

Scenario 1	Scenario 2	Scenario 3
If the handset has connected, the phone has no prompt.	If the phone enables Bluetooth and not connected to the BTH58, the on-screen prompts “Do you want to connect BTH58 to your phone?” . Tap OK to connect, tap Cancel to charge.	If the phone is the first time to pair, the on-screen prompts "Do you want to enable the Bluetooth and connect BTH58 to your phone?". Tap OK to connect, tap Cancel to charge.

TIP

If the phone disables Bluetooth, the on-screen prompts “Do you want to enable the Bluetooth and connect BTH58 to your phone?” . Tap **OK** to enable Bluetooth and connect BTH58.

Use UVC30 Room with VP59

You can connect a UVC30 Room camera to the top USB port of your **VP59 Teams phone** to make video calls.

LED Indicator Instructions

LED Status	Description
Off	The UVC30 Room is not properly connected to the phone or the UVC30 Room is inactive.
Flashing green	There is an incoming call in the Teams meeting.
Solid green	The UVC30 Room is active.
Flashing orange	The UVC30 Room is upgrading firmware.
Flashing red	The UVC30 Room is in recovery mode and the firmware has not been upgraded.

Control UVC30 Camera Position

1. Tap the account avatar and go to **Settings > Device Settings > Control**.

Reset the Position for UVC30 Camera

1. Tap the account avatar and go to **Settings > Device Settings > Control**.
2. Select **Reset**.

Configure the Exposure Settings

1. Tap the account avatar and go to **Settings > Device Settings > Exposure Settings**.

2. Select the desired mode from the **Exposure Mode** field.

Scenario	What to to
If you select Auto Exposure	Select the desired value from the Exposure Compensation, Flicker, Gain Limit, Wide Dynamic Range, Metering field respectively.
If you select Manual Exposure	Select the desired value from the Gain Limit, Wide Dynamic Range, Shutter field respectively.
If you select Shutter Priority	Select the desired value from the Exposure Compensation, Gain Limit, Wide Dynamic Range, Metering, Shutter field respectively.
If you select Brightness Priority	Select the desired value from the Flicker, Wide Dynamic Range, Metering, Brightness field respectively.

Configure the White Balance Setting

1. Tap the account avatar and go to **Settings > Device Settings > White Balance Setting**.
2. Select the desired value from the **White Balance Mode** field and select tap **OK**.
 - **Auto**, it calculates the best white balance setting based on lighting conditions in the room.
 - **Indoor**
 - **Outdoor**
 - **One push**
 - **ATW**, it automatically adjusts the white balance according to the picture taken by the camera.
 - **Manual Setting**, you can manually adjust the color temperature in the **Temperature** field.

Adjust Display Image of the Camera

1. Tap the account avatar and go to **Settings > Device Settings > Graphics**.
2. Select the desired mode from the **Display Mode** field.
 - **High Definition**
 - **Standard**
 - **Mild**
 - **Custom**, you can adjust the **Saturation** and **Sharpness** respectively, and select the desired mode from the **Noise Reduction(2D)** field.

Enable Auto-Framing for UVC30 Camera

Auto-framing is mainly based on face detection, which provides real-time detection and position tracking on all faces in the meeting room. All participants in the output are covered, and the camera can be automatically adjusted based on changes in the number and location of participants.

When the auto-framing feature is enabled, you cannot control the UVC30 camera position.

1. Tap the account avatar and go to **Settings > Device Settings > Advanced**.

2. Tap **Auto Framing**.

TIP

You can adjust tracking speed in the **Tracking Speed** field when you turn on auto framing mode.

Adjust Hangup Mode and Camera Pan Direction

1. Tap the account avatar and go to **Settings > Device Settings > Advanced**.
2. Select the desired value from the **Camera Pan Direction** field.

If you select **Reversed**, the camera pan direction will be reversed when pressing the left and right navigation keys on the remote control.

Reset the Camera

1. Tap the account avatar and go to **Settings > Device Settings > Advanced**.
2. Tap **Reset Camera**.
3. Tap **OK** to reset the camera.

Upgrade UVC30 Camera

You can update the connected UVC30 to the latest version.

Procedure

1. From the web user interface, go to **Camera > Upgrade**.
2. In the **Upgrade** block, click the white box to select a latest firmware from your local system.
3. Click **Upload**.

It will prompt “It will take a few minutes to update the uvc firmware. Please do not power off!”

4. Click **OK**.

The current firmware of the camera will be updated automatically after a few minutes.

Export Camera Log

You can export the camera log to help analyze camera problem.

Procedure

1. From the web user interface, go to **Camera > Upgrade**.
2. In the **Log** block, click **Export** to open the file download window, and then save the file to your local system.

Use CPW65 with CP965

The Yealink CPW65 is a CP Wireless Expansion Mic which works as an audio input device for CP965 phone. It features superior audio technology and supports 360-degree voice pickup range at a radius of up to 10 feet (3 meters) without any wiring troubles.

CPW65 LED Instructions

The CPW65 LED indicator indicates the call, register, and battery's system status. Mute button LED indicator on the wireless expansion microphone CPW65:

LED Status	Description
Solid green	The phone enters the dialing screen. The phone is in a call and unmuted.
Fast flashing red	The phone is receiving an incoming call.
Solid red	The phone is muted.
Fast flashing yellow	The CPW65 is in the registration mode.
Slowly flashing yellow	The CPW65 has registered with the phone, but the CPW65 is out of range. The CPW65 has registered with the phone, but the phone is turned off.
Flashing red and green alternately	The phone is searching for the CPW65 which has registered with it.
Off	The CPW65 is in the idle mode.

Battery LED indicator on the wireless expansion microphone CPW65:

LED Status	Description
Solid green for one second and then off	The CPW65 is turned on.
Solid green for 3 seconds and then off	The CPW65 is in the idle mode.
Solid green	The CPW65 is fully charged.
Solid red	The CPW65 is being charged.
Fast flashing red 3 times and then off	The battery capacity is too low to turn on the CPW65.
Slowly flashing red	The battery capacity is less than 10%.
Off	If you tap the mute button, the battery LED indicator on the CPW65 is still off, it means the CPW65 is turned off.

Charge the CPW65

The phone can power to the USB port, so you can directly charge the CPW65 on the phone.

If it is the first time you use the CPW65, you need to fully charge the CPW65 for normal use. If the CPW65 is not in

use, we recommend you charge the CPW65 even when the battery is full.

Procedure

1. Put the CPW65 on the charging cradle.
2. Connect the charging cradle to the USB port on the phone using a USB cable.

During charging, the battery LED indicator on the CPW65 glows solid red. When the battery capacity reaches 100%, the battery LED indicator on the CPW65 will glow solid green.



NOTE

If your system administrator disables the USB port of the phone, the phone cannot power to the USB port.

Turn the CPW65 On or Off

To use the CPW65 as the external audio input device, you need to turn the CPW65 on first.

Procedure

1. You can do the following to turn on the CPW65:
 - Put the CPW65 on a charging cradle or connect to the charging cable, the CPW65 starts up automatically.
 - If you do not charge the CPW65, long tap  on the CPW65 for 3 seconds.
The battery LED indicator glows green for one second and then goes out.
2. To turn off the CPW65, long tap  on the CPW65 until the battery LED indicator glows red for 3 seconds and then goes out.

NOTE

When the battery is below 10%, the battery LED indicator flashes red, and it will automatically shut down after 10 minutes of standby; when the low battery reaches 0%, it will automatically shut down.

Register the CPW65

To ensure good voice quality of the calls on the phones, you can register CPW65 with the phone to use the CPW65 as the external audio input device.

TIP

If you buy CP965-WirelessMic, the CPW65 is registered with the phone by default.

Procedure

1. Tap the account avatar and go to **Settings > Device Settings > Wireless Microphone**.

2. Select **+** to search for CPW65.

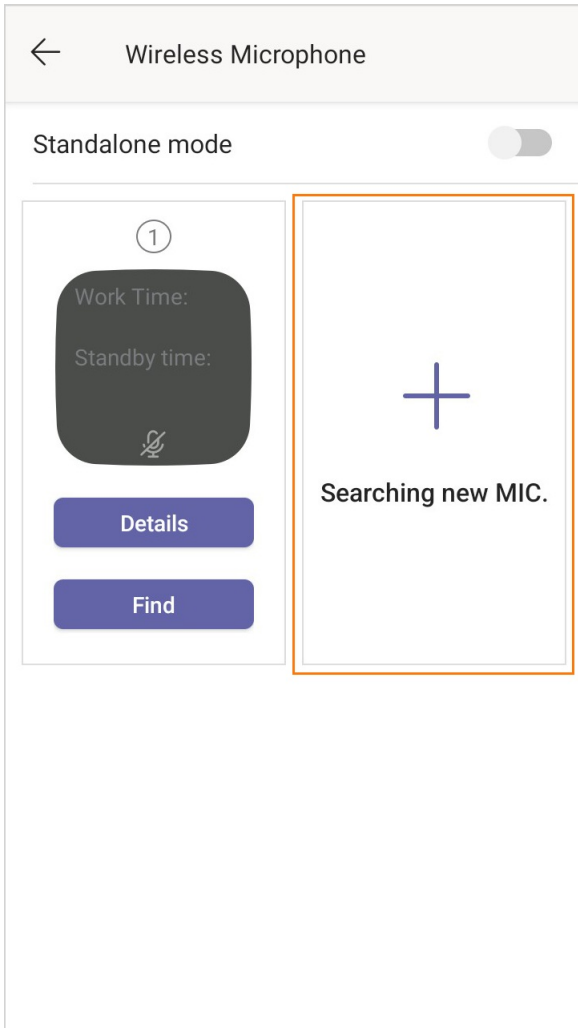

3. Turn on the CPW65.

The CPW65 will enter the registration mode automatically. And the mute LED indicator on the CPW65 fast flashes yellow.

The CPW65 registers with the phone automatically. If the registration is successful, the mute LED indicator on the CPW65 goes out and phone screen prompts the CPW65 information: battery, work time and standby time.

Unregister the CPW65

When you no longer need the CPW65 as the external audio input device, you can unregister it.

Procedure

1. Tap the account avatar and go to **Settings > Device Settings > Wireless Microphone**.
2. Select the desired microphone and then select **Detail**.

3. Select **Unbind**.

←
Wireless Microphone

Register status:
Registered

MIC Model:
CPW65

Firmware:

MICPOD IPEI:
0000333333

Battery:

Standby time:

Work Time:

Unbind

Mute or Unmute the CPW65

During the call, you can mute or unmute the CPW65 at any time.

Procedure

1. Tap  to mute the call.

The mute LED indicator glows red. And the icon  appears in the status bar of the phone.

2. Tap  again to unmute the call.

The mute LED indicator glows green. And the icon  disappears from the status bar of the phone.

Enable Standalone Mode

There are two Mic Mute modes, one is the Synchronous mode, and the other is the Standalone mode.

Mic Mute Mode	Mute/Unmute Status
---------------	--------------------

<p>Synchronous mode (Default)</p>	<p>Synchronous: The muted/unmuted status is synchronized between CPW65 and CP965. For example, if you mute one mic of CPW65, CP965 and the other mic of CPW65 will be muted too.</p>
<p>Standalone mode</p>	<p>Independent: The muted/unmuted status is separated between CPW65 and CP965. For example, if you mute one mic of CPW65, it will not change the status of CP965 and the other mic of CPW65.</p>

Procedure

1. Tap the account avatar and go to **Settings > Device Settings > Wireless Microphone**.
2. Enable or disable **Standalone mode**.

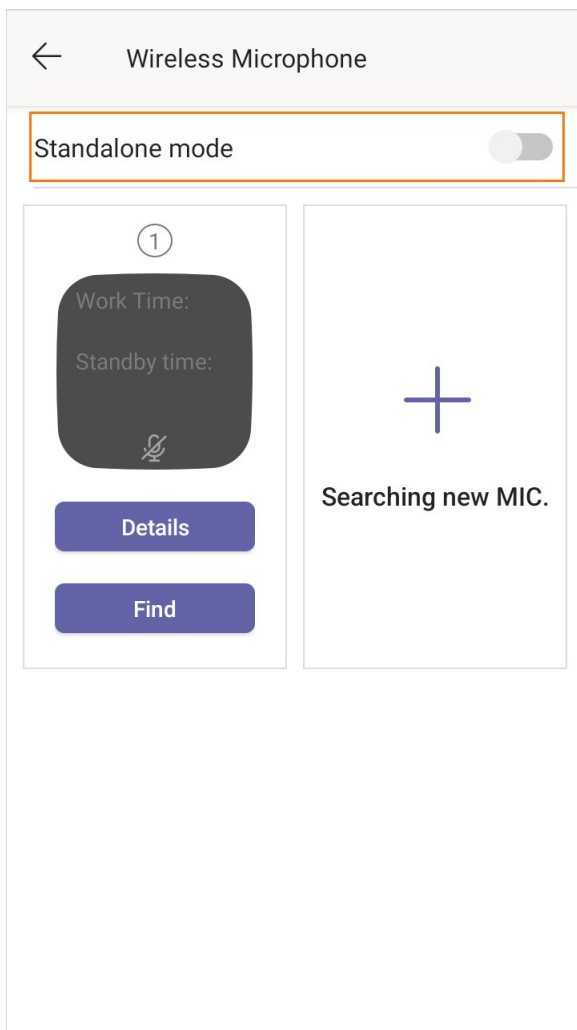

View CPW65 Information

When the CPW65 is registered with the phones, you can view CPW65 status on the phone. Available information of CPW65 includes:

- Register status
- MIC Model

- MICPOD MAC
- Battery
- Standby Time
- Work Time

Procedure

1. Tap the account avatar and go to **Settings > Device Settings > Wireless Microphone**.
2. Select **Detail** from the desired microphone block.

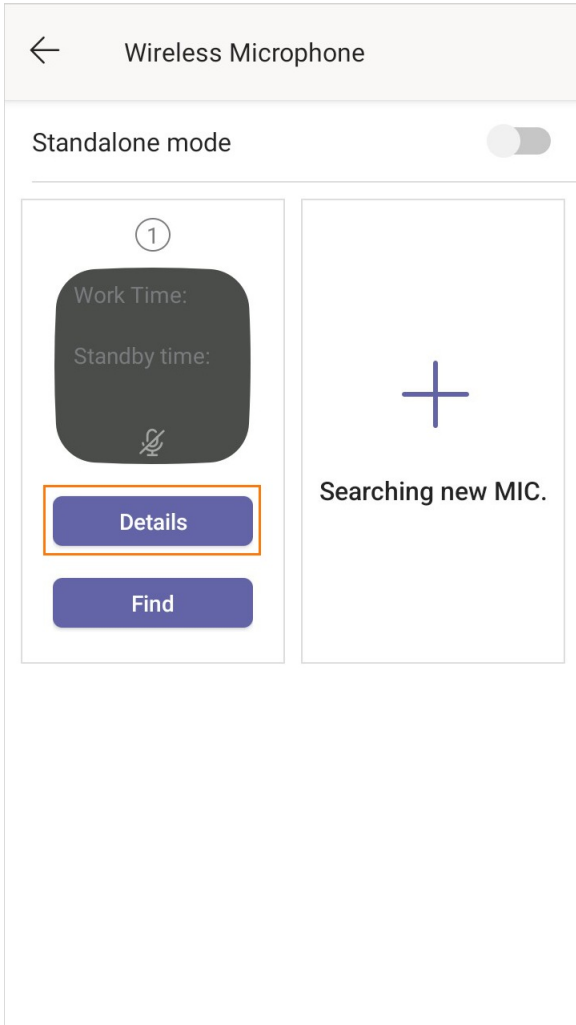

Find the CPW65

You can find the CPW65 which has registered with the phone.

Procedure

1. Tap the account avatar and go to **Settings > Device Settings > Wireless Microphone**.
2. Select **Find** from the desired microphone block.

The mute key LED indicator on the registered CPW65 flashes red and green alternately.